PeopleSoft FSCM 9.2: PeopleSoft Supply Chain Management Integration

September 2022

This software and related documentation are provided under a license agreement containing restrictions on use and disclosure and are protected by intellectual property laws. Except as expressly permitted in your license agreement or allowed by law, you may not use, copy, reproduce, translate, broadcast, modify, license, transmit, distribute, exhibit, perform, publish, or display any part, in any form, or by any means. Reverse engineering, disassembly, or decompilation of this software, unless required by law for interoperability, is prohibited.

The information contained herein is subject to change without notice and is not warranted to be error-free. If you find any errors, please report them to us in writing.

If this is software, software documentation, data (as defined in the Federal Acquisition Regulation), or related documentation that is delivered to the U.S. Government or anyone licensing it on behalf of the U.S. Government, then the following notice is applicable:

U.S. GOVERNMENT END USERS: Oracle programs (including any operating system, integrated software, any programs embedded, installed, or activated on delivered hardware, and modifications of such programs) and Oracle computer documentation or other Oracle data delivered to or accessed by U.S. Government end users are "commercial computer software," "commercial computer software documentation," or "limited rights data" pursuant to the applicable Federal Acquisition Regulation and agency-specific supplemental regulations. As such, the use, reproduction, duplication, release, display, disclosure, modification, preparation of derivative works, and/or adaptation of i) Oracle programs (including any operating system, integrated software, any programs embedded, installed, or activated on delivered hardware, and modifications of such programs), ii) Oracle computer documentation and/or iii) other Oracle data, is subject to the rights and limitations specified in the license contained in the applicable contract. The terms governing the U.S. Government's use of Oracle cloud services are defined by the applicable contract for such services. No other rights are granted to the U.S. Government.

This software or hardware is developed for general use in a variety of information management applications. It is not developed or intended for use in any inherently dangerous applications, including applications that may create a risk of personal injury. If you use this software or hardware in dangerous applications, then you shall be responsible to take all appropriate fail-safe, backup, redundancy, and other measures to ensure its safe use. Oracle Corporation and its affiliates disclaim any liability for any damages caused by use of this software or hardware in dangerous applications.

Oracle®, Java, and MySQL are registered trademarks of Oracle and/or its affiliates. Other names may be trademarks of their respective owners.

Intel and Intel Inside are trademarks or registered trademarks of Intel Corporation. All SPARC trademarks are used under license and are trademarks or registered trademarks of SPARC International, Inc. AMD, Epyc, and the AMD logo are trademarks or registered trademarks of Advanced Micro Devices. UNIX is a registered trademark of The Open Group.

This software or hardware and documentation may provide access to or information about content, products, and services from third parties. Oracle Corporation and its affiliates are not responsible for and expressly disclaim all warranties of any kind with respect to third-party content, products, and services unless otherwise set forth in an applicable agreement between you and Oracle. Oracle Corporation and its affiliates will not be responsible for any loss, costs, or damages incurred due to your access to or use of third-party content, products, or services, except as set forth in an applicable agreement between you and Oracle.

Documentation Accessibility

For information about Oracle's commitment to accessibility, visit the Oracle Accessibility Program website at <https://docs.oracle.com/pls/topic/lookup?ctx=acc&id=docacc>.

Access to Oracle Support

Oracle customers that have purchased support have access to electronic support through My Oracle Support. For information, visit <https://docs.oracle.com/pls/topic/lookup?ctx=acc&id=info> or visit <https://docs.oracle.com/pls/topic/lookup?ctx=acc&id=trs> if you are hearing impaired.

Contents

- Preface: Preface.....xi**
- Understanding the PeopleSoft Online Help and PeopleBooks..... xi
- Hosted PeopleSoft Online Help..... xi
- Locally Installed Help..... xi
- Downloadable PeopleBook PDF Files.....xi
- Common Help Documentation.....xi
- Field and Control Definitions..... xii
- Typographical Conventions..... xii
- ISO Country and Currency Codes..... xii
- Region and Industry Identifiers..... xiii
- Translations and Embedded Help..... xiii
- Using and Managing the PeopleSoft Online Help..... xiv
- PeopleSoft FSCM Related Links..... xiv
- Contact Us..... xiv
- Follow Us..... xiv
- Chapter 1: Getting Started with Supply Chain Management Integration..... 17**
- Navigating PeopleSoft SCM Integration Documentation..... 17
- PeopleSoft Application Fundamentals..... 19
- Integration Implementation..... 20
- Common Elements Used in Supply Chain Management Integration..... 20
- Chapter 2: Understanding PeopleSoft Supply Chain Management Enterprise Integration Points..... 23**
- PeopleSoft SCM Inbound EIPs..... 23
- Understanding the Inbound EIP Architecture..... 23
- PeopleSoft SCM Outbound EIPs..... 26
- Understanding the Outbound Transaction Architecture..... 26
- Comprehensive List of SCM EIPs..... 28
- Chapter 3: Implementing Integrations..... 57**
- Setting Up Service Operations..... 57
- Pages Used to Set Up Service Operations..... 61
- Setting Up Chunking..... 62
- Pages Used to Set Up Chunking..... 63
- Setting Up Electronic Data Collections..... 64
- Page Used to Set Up Electronic Data Collections..... 64
- Data Collection Setup Page..... 64
- Setting Up BackBone InterlinX..... 65
- Pages Used to Set Up Backbone InterlinX..... 66
- Understanding BackBone InterlinX..... 66
- Prerequisites..... 67
- Define Target Set Page..... 67
- Integration Definition Page..... 67
- Implementing XML Mapper..... 71
- Pages Used to Set Up XML Mapper..... 71
- Understanding XML Mapper..... 72
- Prerequisites to Using XML Mapper..... 72
- Defining Maps Page..... 72

Map Detail Page.....	74
Define Map Sets Page.....	75
Define Node Associations Page.....	76
Chapter 4: Processing Enterprise Integration Points (EIPs).....	79
Processing Inbound EIPs.....	79
Pages Used to Process Inbound EIPs.....	79
Transaction Maintenance Page.....	79
Data Def Maint Page.....	81
Purging Page.....	83
Processing Outbound EIPs.....	84
Page Used to Process Outbound EIPs.....	84
Publish Outbound Message Page.....	84
Processing Backbone Interlinks.....	85
Page Used to Process Backbone Interlinks.....	85
BankBone InterlinX - Process Request Page.....	85
Chapter 5: Understanding Warehouse Management Systems.....	87
General WMS Integration Issues.....	87
System-Wide Assumptions About WMS Integration.....	87
WMS EIPs.....	89
The Order-to-Cash Business Process in a WMS Integration.....	92
Order Entry.....	93
Reservation Processing.....	94
Order Release Processing.....	94
Order Changes.....	96
Shipping Processing.....	96
The Procure-to-Pay Business Process in a WMS Integration.....	97
Requisitions.....	98
Purchase Orders.....	99
Purchase Order Expected Receipts Processing.....	99
Receiving.....	101
Four-Wall Warehousing Functions in a WMS Integration.....	102
Inventory Adjustments.....	103
Storage Location Transfers (Inventory Status Updates).....	103
Physical Inventory (Stock Quantity Snapshots).....	104
Static Information Updates in a WMS Integration.....	105
Customer Data.....	106
Supplier Data.....	106
Item Data.....	106
Carrier and Shipping Method Data.....	106
Location Data.....	106
Chapter 6: Integrating With a Third-Party Point-of-Use Supplier System.....	107
Understanding POU Supplier Systems.....	107
Assumptions About POU Supplier System Integration.....	108
Definition of Items and Par Locations for a POU Supplier Integration.....	108
Chunking Rules for Streamlining POU Supplier Integration Processes.....	109
POU Suppliers as Par Locations in PeopleSoft Inventory.....	109
RTVs for POU Supplier Items.....	109
Defining Par Location Data for the POU Supplier and the PeopleSoft System.....	109
Managing Item Replenishment Data in the POU Supplier and the PeopleSoft System.....	110
Restocking a POU Supplier.....	111
Using POU Supplier EIPs.....	112

Following the Data Flow Between the PeopleSoft System and the POU Supplier System.....	112
Managing Subscription Errors for POU EIPs.....	113
Chapter 7: Integrating With a Third-Party Surgical Resource Software Application.....	115
Understanding SRS Applications.....	115
Defining Assumptions of an SRS Application Integration.....	115
Defining Items and Par Locations for an SRS Application Integration.....	115
Using Chunking to Streamline SRS Application Integration Processes.....	116
Creating RTVs for Surgical Resource Par Location Items.....	116
Implementing an SRS Application Integration.....	117
Defining Par Location Data for the SRS Application and the PeopleSoft System.....	117
Stocking Case Carts From a Surgical Resource Par Location.....	117
Maintaining Item Replenishment Data in the SRS Application and the PeopleSoft System.....	119
Restocking a Surgical Resource Par Location.....	120
Using SRS Application EIPs.....	121
Managing Errors for SRS EIPs.....	123
Chapter 8: Designing an Electronic Data Collection System.....	125
Understanding Electronic Data Collection.....	125
Setting Up Electronic Data Collection Defaults.....	125
Setting Up Labels.....	125
Page Used to Set Up Labels.....	126
Data Collection Label Setup Page.....	126
Setting Up the UCC/EAN Manufacturer ID.....	127
Pages Used to Set Up the UCC/EAN Manufacturer ID.....	127
UCC/EAN Manufacturer ID Page.....	127
Setting Up the Wedge Command Code.....	128
Setting Up Unit of Measure.....	128
Setting Up Picking.....	128
Setting Up Putaway.....	128
Chapter 9: Using an Electronic Data Collection System.....	129
Understanding Electronic Data Collection.....	129
Device Selection.....	130
Using Electronic Data Collection Transactions.....	131
Using Background Transaction Processes.....	132
Purging Transactions.....	134
Generating Labels.....	134
Managing Files.....	135
Pages Used to Print Labels.....	137
Common Elements Used in This Section.....	138
Purchasing Receipt Labels Page.....	139
Completion Label - Completion Labels Page.....	140
Pull Ticket/Pull List Options Page.....	141
Printing Kanban Card Page.....	142
Kanban Card Range Page.....	145
Storage Location Label Page.....	145
Item Storage Label Page.....	145
Storage Container Label Page.....	146
Shipping Carton Label Page.....	147
Shipping Serial Label Page.....	150
Printing Shipping Container Label.....	150
Chapter 10: Understanding Record Layouts for the Electronic Data Collection System.....	153
Par Location Count and Physical Accounting File Formats.....	153

Par Location Count.....	153
Physical Accounting.....	157
Label Extract File Record Definitions.....	158
Item Usage Label.....	159
Item Storage Label.....	160
Storage Container Label.....	161
Storage Location Label.....	161
Shipping Carton Label.....	162
Shipping Container Label.....	165
Shipping Serial Number Label.....	168
Production Completion Label.....	168
Purchasing Receipt Label.....	169
Kanban Card and Pull Ticket Label.....	170
Picking Plan Extract File Record Definitions.....	173
Inventory Picking Extract File Format.....	173
Manufacturing Picking Extract File Format.....	178
Chapter 11: Integrating with Transportation Management Systems.....	183
Understanding the Transportation Management System Integration with PeopleSoft Inventory.....	183
Setting Up PeopleSoft for TMS Integration.....	185
Pages Used to Set Up PeopleSoft for TMS Integration.....	185
Setting up the TMS Integration.....	186
Publishing the TMS Order Release EIP.....	187
Pages Used to Publish the TMS Order Release EIP.....	187
Understanding the TMS Order Release Process.....	187
TMS Order Release Selection Criteria Page.....	188
Communicating Order Changes to the TMS.....	190
Understanding TMS Processing.....	191
Receiving the Load Notification EIP.....	192
Pages Used to Subscribe to the Load Notification EIP.....	192
Understanding the Load Notification EIP Process.....	192
TMS Load Notification Page.....	193
Transaction Maintenance Page.....	195
Chapter 12: Integrating with PeopleSoft CRM.....	197
Understanding PeopleSoft SCM Integration with PeopleSoft CRM.....	197
Common Object Integrations.....	197
PeopleSoft Order Management Integration with PeopleSoft Order Capture.....	198
PeopleSoft Billing Integration with PeopleSoft CRM 360 Degree View.....	198
PeopleSoft SCM Integration with PeopleSoft FieldService.....	199
Using CRM EIPs.....	199
CRM EIPs.....	199
Chapter 13: Integrating with Supply Chain Business Modeler.....	205
Understanding the PeopleSoft Supply Chain Management Integration with the Supply Chain Business Modeler.....	205
Exporting Data to Supply Chain Business Modeler.....	211
Page Used to Export Data to Supply Chain Business Modeler.....	211
Export data to SCBM Page.....	211
Importing Data From Supply Chain Business Modeler.....	214
Page Used to Import Data From Supply Chain Business Modeler.....	215
Import data from SCBM Page.....	215
Chapter 14: Integrating with Oracle's Demantra Demand Management.....	217
Understanding Demantra Integration.....	217

Common Elements Used in Demantra.....	220
Setting Up Calendar and Weight Profiles.....	220
Pages Used to Set Up Calendar and Weight Profiles.....	221
Understanding Calendars.....	221
Defining Calendar Patterns Page.....	222
Define Calendar Structure Page.....	223
Periods Page.....	223
Calendar Weight Profiles Page.....	227
Change Calendar Weights Page.....	228
Mapping PeopleSoft Fields To Demantra Fields.....	229
Pages Used to Map and Maintain Forecasting Fields.....	229
Define Field Mappings - Base Page.....	230
Define Field Mapping - Customers Page.....	233
Define Field Mappings - Sales Page.....	234
Building and Reviewing Demand History.....	235
Pages Used to Build and Review Demand History.....	235
Understanding How to Build Demand History.....	236
Building Demand History Page.....	236
Reviewing Demand History Page.....	239
Exporting Data to Demantra.....	241
Pages Used to Export Data to Demantra.....	241
Understanding Data Export.....	242
Defining Export Specifications Page.....	242
Maintaining Export Controls Page.....	247
Export Demand Page.....	248
Importing Data from Demantra.....	249
Pages Used to Import Data From Demantra.....	249
Defining Import Specifications Page.....	250
Import Forecasts Page.....	251
Reviewing and Updating Imported Forecasts.....	252
Pages Used to Review and Update Imported Forecasts.....	253
Review Imported Forecasts Page.....	253
Forecast Item Details Page.....	253
Forecast Period Data Page.....	255
Forecast Update Page.....	256
Chapter 15: Calculating Sales and Use Tax in Supply Chain Management.....	257
Understanding PeopleSoft Tax Solutions.....	257
Comparing PeopleSoft Tax Tables to Third-Party Tax Suppliers.....	257
Understanding Tax Integration Technologies.....	258
Setting Up Third-Party Tax Solutions.....	259
Using Tax Product Groups.....	261
Associating Address Information with Geocodes.....	262
Page Used to Associate Address Information with Geocodes.....	262
Understanding Geocodes.....	262
Tax Geocode Selection Page.....	263
Interacting with Third-Party Tax Suppliers.....	263
Interacting with Third-Party Tax Solutions During Geocode Lookup.....	265
Interacting with Third-Party Tax Suppliers During Online Tax Calculations.....	265
Interacting with Third-Party Tax Suppliers During Invoicing.....	267
Interacting with Third-Party Tax Suppliers During the Order Completion Process.....	267
Viewing Tax Calculation Errors in PeopleSoft Billing.....	267

Viewing Errors When Calculating Taxes Online.....	268
Viewing Errors When Calculating Taxes Through the Invoicing Process.....	268
Reviewing Third-Party Tax Liability Reporting.....	268
Comparing US and Canadian Tax Support.....	268
Reviewing and Modifying Tax Jurisdiction Level Translation.....	269
Pages Used to Modify the Vertex O Series Tax Jurisdiction Translation Map.....	269
Understanding Tax Authority Code Translation.....	269
Define Maps Page.....	270
Chapter 16: Integrating With Vertex O Series.....	273
Understanding PeopleSoft Integration With Vertex O Series.....	273
Configuring Vertex O Series Integration.....	274
Pages Used to Configure Vertex O Series Integration.....	274
Queue Definitions Page.....	274
Service Operation - General Page.....	274
Service Operation - General Page.....	275
Node Definitions Page.....	275
Setting Up PeopleSoft Installation Options for Vertex O Series.....	276
Testing the Vertex O Series Integration.....	277
Chapter 17: Integrating With Vertex Q Series.....	279
Understanding PeopleSoft Business Interlinks to Vertex Q Series.....	279
Identifying Vertex Q Series Plug-in Locations.....	279
Identifying Vertex Q Series DLLs and Shared Library Locations.....	280
Setting Up Variables for the Vertex Database Location.....	281
Setting Up Vertex on a Microsoft Windows NT or Windows 2000 Platform.....	281
Setting Up Vertex on a UNIX Platform.....	283
Setting Up PeopleSoft Installation Options for Vertex Q Series.....	283
Testing the Vertex Q Series Installation.....	283
Troubleshooting Installation Errors.....	283
Chapter 18: Integrating With Taxware Enterprise.....	285
Understanding PeopleSoft Integration With Taxware Enterprise.....	285
Configuring Taxware Enterprise Integration.....	286
Pages Used to Configure Taxware Enterprise Integration.....	286
Queue Definitions Page.....	286
Service Operation - General Page.....	286
Service Operations - Routings Page.....	287
Node Definitions Page.....	287
Setting Up PeopleSoft Installation Options for Taxware Enterprise.....	287
Testing the Taxware Enterprise Integration.....	289
Chapter 19: Integrating with Taxware Sales and Use Tax.....	291
Understanding PeopleSoft Business Interlinks to Taxware Sales and Use Tax.....	291
Identifying Taxware Plug-in Locations.....	291
Identifying Taxware DLLs and Shared Library Locations.....	292
Setting Up Variables for the Taxware Database Location.....	293
Setting Up Taxware on a Microsoft Windows NT or Windows 2000 Platform.....	293
Setting Up Taxware on a UNIX Platform.....	293
Setting Up PeopleSoft Installation Options for Taxware Sales and Use Tax.....	294
Testing the Taxware Sales and Use Tax Installation.....	294
Troubleshooting Installation Errors.....	295
Chapter 20: Scenarios for Integration With PeopleSoft Supply Chain Management.....	297
Understanding This Troubleshooting.....	297
Common Elements Used.....	298

Example: Setting Up the Sales Order Load EIP.....	299
Page Used to Set Up the Sales Order Load EIP.....	299
Understanding the Sales Order Load EIP.....	299
Service Operations-General Page.....	300
Queue Definitions Page.....	301
Service Operations-Handlers Page.....	302
Service Operations-Routings Page.....	303
Routings-Parameters Page.....	303
Node Definitions Page.....	304
Inbound File Loader Rules Page.....	305
File Inbound Page.....	306
Example: Processing the Sales Order Load EIP.....	307
Pages Used to Process Sales Orders Load EIP.....	308
Inbound File Processing Page.....	308
Inbound File Page.....	309
Electronic Commerce Page.....	310
Data Def Maint Page.....	311
Order Completion Page.....	313
Example: Setting Up the Sales Order Acknowledgement EIP.....	314
Pages Used to Set Up the Sales Order Acknowledgement EIP.....	314
Understanding the Sales Order Acknowledgment EIP.....	315
Contact Page.....	315
Service Operations-General Page.....	317
Queue Definitions Page.....	319
Service Operations-Handlers Page.....	320
Service Operations-Routings Page.....	320
Routings-Parameters Page.....	321
Node Definitions Page.....	323
Nodes-Connectors Page.....	324
Batch Publish Rules Page.....	324
Customer ID Chunk Page.....	325
Example: Processing the Sales Order Acknowledgement EIP.....	326
Pages Used to Process the Sales Order Acknowledgement EIPs.....	326
Publish Outbound Message Page.....	326
Example: Setting Up the Purchase Order Dispatch EIP.....	328
Pages Used to Set Up the Purchase Order Dispatch EIP.....	328
Understanding the Purchase Order Dispatch EIP.....	328
PO Header Details Page.....	329
Service Operations-General Page.....	330
Queue Definitions Page.....	332
Service Operations-Handlers Page.....	332
Service Operations-Routings Page.....	333
Routings-Parameters Page.....	334
Node Definitions Page.....	335
Nodes-Connectors Page.....	336
Batch Publish Rules Page.....	336
Setup Supplier to Node Page.....	337
Example: Processing the Purchase Order Dispatch EIP.....	338
Pages Used to Process the Purchase Order EIP.....	338
Dispatch Purchase Orders Page.....	339
Publish Outbound Message Page.....	339

Example: Setting Up the Advanced Shipping Notice EIP.....	341
Pages Used to Set Up the Advanced Shipping Notice EIP.....	341
Understanding the Advanced Shipping Notice EIP.....	342
Business Unit Definition - Inventory Options Page.....	343
Contact Page.....	344
Service Operations-General Page.....	345
Queue Definitions Page.....	347
Service Operations-Handlers Page.....	347
Service Operations-Routings Page.....	348
Routings-Parameters Page.....	349
Node Definitions Page.....	351
Nodes-Connectors Page.....	352
Batch Publish Rules Page.....	352
Customer ID Chunk Page.....	353
Example: Processing the Advanced Shipping Notice EIP.....	354
Pages Used to Process the Advanced Shipping Notice EIP.....	355
Publish Outbound Message Page.....	355
Data Separation.....	357
Example: Setting Up the Billing Invoice EIP.....	357
Pages Used to Process Billing Invoices.....	357
Understanding the Billing Invoice EIP.....	359
Contact Page.....	359
Service Operations-General Page.....	361
Queue Definitions Page.....	363
Service Operations-Handlers Page.....	364
Service Operations-Routings Page.....	364
Routings-Parameters Page.....	365
Node Definitions Page.....	367
Nodes-Connectors Page.....	367
Batch Publish Rules Page.....	368
Customer ID Chunk Page.....	369
Publishing Billing Invoices.....	370
Pages Used to Process the Billing Invoice EIP.....	371
Publish Outbound Message Page.....	371
Chapter 21: Helpful Hints for Integration With PeopleSoft Supply Chain Management.....	373
Understanding This Troubleshooting EIPs.....	373
Helpful Hints About EIPs.....	373
Helpful Hints about Integration Broker in PeopleTools 8.48 and Higher.....	375

Preface

Understanding the PeopleSoft Online Help and PeopleBooks

The PeopleSoft Online Help is a website that enables you to view all help content for PeopleSoft applications and PeopleTools. The help provides standard navigation and full-text searching, as well as context-sensitive online help for PeopleSoft users.

Hosted PeopleSoft Online Help

You can access the hosted PeopleSoft Online Help on the [Oracle Help Center](#). The hosted PeopleSoft Online Help is updated on a regular schedule, ensuring that you have access to the most current documentation. This reduces the need to view separate documentation posts for application maintenance on My Oracle Support. The hosted PeopleSoft Online Help is available in English only.

To configure the context-sensitive help for your PeopleSoft applications to use the Oracle Help Center, see [Configuring Context-Sensitive Help Using the Hosted Online Help Website](#).

Locally Installed Help

If you're setting up an on-premise PeopleSoft environment, and your organization has firewall restrictions that prevent you from using the hosted PeopleSoft Online Help, you can install the online help locally. See [Configuring Context-Sensitive Help Using a Locally Installed Online Help Website](#).

Downloadable PeopleBook PDF Files

You can access downloadable PDF versions of the help content in the traditional PeopleBook format on the [Oracle Help Center](#). The content in the PeopleBook PDFs is the same as the content in the PeopleSoft Online Help, but it has a different structure and it does not include the interactive navigation features that are available in the online help.

Common Help Documentation

Common help documentation contains information that applies to multiple applications. The two main types of common help are:

- Application Fundamentals
- Using PeopleSoft Applications

Most product families provide a set of application fundamentals help topics that discuss essential information about the setup and design of your system. This information applies to many or all applications in the PeopleSoft product family. Whether you are implementing a single application, some combination of applications within the product family, or the entire product family, you should be familiar with the contents of the appropriate application fundamentals help. They provide the starting points for fundamental implementation tasks.

In addition, the *PeopleTools: Applications User's Guide* introduces you to the various elements of the PeopleSoft Pure Internet Architecture. It also explains how to use the navigational hierarchy, components, and pages to perform basic functions as you navigate through the system. While your application or implementation may differ, the topics in this user's guide provide general information about using PeopleSoft applications.

Field and Control Definitions

PeopleSoft documentation includes definitions for most fields and controls that appear on application pages. These definitions describe how to use a field or control, where populated values come from, the effects of selecting certain values, and so on. If a field or control is not defined, then it either requires no additional explanation or is documented in a common elements section earlier in the documentation. For example, the Date field rarely requires additional explanation and may not be defined in the documentation for some pages.

Typographical Conventions

The following table describes the typographical conventions that are used in the online help.

<i>Typographical Convention</i>	<i>Description</i>
Key+Key	Indicates a key combination action. For example, a plus sign (+) between keys means that you must hold down the first key while you press the second key. For Alt+W , hold down the Alt key while you press the W key.
... (ellipses)	Indicate that the preceding item or series can be repeated any number of times in PeopleCode syntax.
{ } (curly braces)	Indicate a choice between two options in PeopleCode syntax. Options are separated by a pipe ().
[] (square brackets)	Indicate optional items in PeopleCode syntax.
& (ampersand)	When placed before a parameter in PeopleCode syntax, an ampersand indicates that the parameter is an already instantiated object. Ampersands also precede all PeopleCode variables.
⇒	This continuation character has been inserted at the end of a line of code that has been wrapped at the page margin. The code should be viewed or entered as a single, continuous line of code without the continuation character.

ISO Country and Currency Codes

PeopleSoft Online Help topics use International Organization for Standardization (ISO) country and currency codes to identify country-specific information and monetary amounts.

ISO country codes may appear as country identifiers, and ISO currency codes may appear as currency identifiers in your PeopleSoft documentation. Reference to an ISO country code in your documentation does not imply that your application includes every ISO country code. The following example is a country-specific heading: "(FRA) Hiring an Employee."

The PeopleSoft Currency Code table (CURRENCY_CD_TBL) contains sample currency code data. The Currency Code table is based on ISO Standard 4217, "Codes for the representation of currencies," and also relies on ISO country codes in the Country table (COUNTRY_TBL). The navigation to the pages where you maintain currency code and country information depends on which PeopleSoft applications you are using. To access the pages for maintaining the Currency Code and Country tables, consult the online help for your applications for more information.

Region and Industry Identifiers

Information that applies only to a specific region or industry is preceded by a standard identifier in parentheses. This identifier typically appears at the beginning of a section heading, but it may also appear at the beginning of a note or other text.

Example of a region-specific heading: "(Latin America) Setting Up Depreciation"

Region Identifiers

Regions are identified by the region name. The following region identifiers may appear in the PeopleSoft Online Help:

- Asia Pacific
- Europe
- Latin America
- North America

Industry Identifiers

Industries are identified by the industry name or by an abbreviation for that industry. The following industry identifiers may appear in the PeopleSoft Online Help:

- USF (U.S. Federal)
- E&G (Education and Government)

Translations and Embedded Help

PeopleSoft 9.2 software applications include translated embedded help. With the 9.2 release, PeopleSoft aligns with the other Oracle applications by focusing our translation efforts on embedded help. We are not planning to translate our traditional online help and PeopleBooks documentation. Instead we offer very direct translated help at crucial spots within our application through our embedded help widgets. Additionally, we have a one-to-one mapping of application and help translations, meaning that the software and embedded help translation footprint is identical—something we were never able to accomplish in the past.

Using and Managing the PeopleSoft Online Help

Select About This Help in the left navigation panel on any page in the PeopleSoft Online Help to see information on the following topics:

- Using the PeopleSoft Online Help.
- Managing hosted Online Help.
- Managing locally installed PeopleSoft Online Help.

PeopleSoft FSCM Related Links

[Oracle Help Center](#)

[Hosted Online Help](#)

[PeopleSoft Information Portal](#)

[My Oracle Support](#)

Financial and Supply Chain Management information for Search Framework search engine can be found in PeopleSoft Application Fundamentals documentation. For application specific information, see the "Understanding Search Pages within Components " (Application Fundamentals) topic.

[PeopleSoft Training from Oracle University](#)

[PeopleSoft Video Feature Overviews on YouTube](#)

[PeopleSoft Business Process Maps \(Microsoft Visio format\)](#)

[PeopleSoft Spotlight Series](#)

Contact Us

Send your suggestions to pssoft-infodev_us@oracle.com.

Please include the applications update image or PeopleTools release that you're using.

Follow Us

<i>Icon</i>	<i>Link</i>
	<u>YouTube</u>

Icon	Link
	Twitter@PeopleSoft_Info.
	PeopleSoft Blogs
	LinkedIn

Chapter 1

Getting Started with Supply Chain Management Integration

Navigating PeopleSoft SCM Integration Documentation

If you are using integration with the PeopleSoft Supply Chain Management (SCM) applications, please refer to this topic to find the information you need.

PeopleSoft SCM provides powerful integration technology. You can integrate with specific application suppliers or share transaction or definitional data directly with suppliers or customers.

Oracle has information organized for functional users and technical implementers on how to set up and use enterprise integration points (EIPs) in PeopleSoft Supply Chain Management.

Integration Information Flow

When you're learning about EIPs, it is suggested that you follow the following order of information:

Step	Documentation	Type of Information	Primary Audience
Learning what EIPs are delivered with your application.	Application documentations	Functional descriptions of EIPs	Power users and managers
A high level understanding of the EIP architecture, and the types of technologies for which SCM delivers EIPs.	<i>PeopleSoft Supply Chain Management Integration</i>	EIP overview information Descriptions of EIP groups integrating to specific technologies (warehouse management systems, electronic data collection, and so forth)	Power users and managers
How to set up EIPs and understand the delivered design patterns.	<i>PeopleSoft : Enterprise Components</i>	EIP setup information Design pattern descriptions	Functional and technical implementers
Mapping EIP data	Interactive Services Repository	Technical details for each EIP	Functional and technical implementers

Step	Documentation	Type of Information	Primary Audience
Creating or customizing EIPs	<i>PeopleTools: Integration Broker</i>	Information on using this technology to create your own EIPs	Functional and technical implementers

Power Users and Managers

If you are looking for information on which EIPs to use and what they can do for you, you can find overview information as follows.

Area	Location
Overview of EIPs and integration technology	See PeopleSoft SCM Inbound EIPs .
Functional description of individual EIPs.	The respective application documentation.
EDI information	See "PeopleSoft Electronic Data Interchange" (PeopleSoft Electronic Data Interchange).
Warehouse Management Systems information	See General WMS Integration Issues .
Healthcare application information	The respective application documentation.
Electronic data collection information	See Understanding Electronic Data Collection .
Sales and Use Tax information	See Understanding PeopleSoft Business Interlinks to Taxware Sales and Use Tax .
Transportation Management information	See Understanding the Transportation Management System Integration with PeopleSoft Inventory .

Functional and Technical Implementers

Resources for technical information are in the Enterprise Integration section of the *PeopleSoft: Enterprise Components*, *PeopleTools: Integration Broker* and the Interactive Services Repository. There are also specific overview sections and examples in the *PeopleSoft Supply Chain Management Integration*

Area	Location
EIP setup information	See Setting Up Service Operations .

Area	Location
Chunking information	See Setting Up Chunking .
EIP processing Information	See Processing Inbound EIPs . See Processing Outbound EIPs . The respective application documentation.
Inbound error handling	See Processing Inbound EIPs .
General technical information	<i>PeopleTools: Integration Broker</i>
Technical details for each EIP	For technical details about individual EIPs, use the Interactive Services Repository (ISR) in the My Oracle Support website located at https://support.oracle.com/CSP/ui/flash.html .
Inbound EIP (subscribe) specific information	See Processing Inbound EIPs . See Understanding This Troubleshooting .
Outbound EIP (publish) specific information	See Processing Outbound EIPs . See Understanding This Troubleshooting .

Related Links

[PeopleSoft SCM Inbound EIPs](#)

PeopleSoft Application Fundamentals

The *PeopleSoft Supply Chain Management Integration 9.1 PeopleBook* provides you with implementation and processing information for the PeopleSoft system. However, additional, essential information describing the setup and design of the system resides in companion documentation. The companion documentation consists of important topics that apply to many or all of Oracle's PeopleSoft applications across the Financials, Enterprise Service Automation, and Supply Chain Management product lines. You should be familiar with the contents of these PeopleBooks.

The following companion PeopleBooks apply specifically to the *PeopleSoft Supply Chain Management Integration 9.1 PeopleBook*.

- *PeopleSoft Applications Fundamentals 9.1 PeopleBook*
- *PeopleTools PeopleBook: Integration Broker*

- *PeopleSoft Components PeopleBook*

Integration Implementation

There are no table-loading implementation steps for integrations. In the planning phase of the implementation, take advantage of all PeopleSoft sources of information, including the installation guides, table-loading sequences, data models, and business process maps. A complete list of these resources appears in the preface in the *PeopleSoft Applications Fundamentals* with information about where to find the most current version of each.

Related Links

"PeopleSoft Application Fundamentals Overview" (Application Fundamentals)

Common Elements Used in Supply Chain Management Integration

Field or Control	Description
As of Date	The first date for which a report or process includes data.
BU or Business Unit	An identification code that represents a high-level organization of business information. You can use a business unit to define regional or departmental units within a larger organization.
Description	Freeflow text up to 256 characters.
Short Description	Freeflow text up to 15 characters.
Effective Date	Date which a table row becomes effective; the date that an action begins. For example, if you want to close a ledger on June 30, the effective date for the ledger closing would be July 1. This date also determines when you can view and change the information. Pages and batch processes that use the information use the current row. See <i>PeopleTools: Applications User's Guide</i>
Language or Language Code	The language of the field labels and report headings of reports to print. The filed values appear as you enter them. Language also refers to the language spoken by an employee, applicant, or non-employee.

Field or Control	Description
Process Frequency	Designates the appropriate frequency to process: <i>Once</i> : executes the request the next time the batch process runs. After the batch process runs, the process frequency is automatically set to <i>Don't Run</i> . <i>Always Executes</i> : executes the request every time the batch process runs. <i>Don't Run</i> : Ignores the request when the batch process runs.
Process Monitor	View the status of submitted process requests. <i>See PeopleTools: Process Scheduler</i>
Report ID	The report identifier.
Report Manager	View report content, check the status of a report, and see detailed messages. <i>See PeopleTools: Process Scheduler</i>
Run Control ID	A request identification that represents a set of selection criteria for a report or process.
Run	Specify the location where a process or job runs and the process output format.
Status	Check the progress of a report or process. A valid status is <i>Posted, Not Posted, Generated, Processing, or Scheduled</i> .
User ID	The system identifier for the individual who generates a transactions.
Instance or Pres Instance	The number that represents where the request is in the queue.

PeopleTools: Applications User's Guide

Chapter 2

Understanding PeopleSoft Supply Chain Management Enterprise Integration Points

PeopleSoft SCM Inbound EIPs

Third-party systems can send information to PeopleSoft applications using a number of integration points established throughout the system. Depending on the application, various technologies provide multiple options for interacting with the PeopleSoft system. Each option provides audit trails, validations, and error handling to insure that data integrity is maintained within the PeopleSoft database.

Understanding the Inbound EIP Architecture

Depending on the requirements of the interacting system and the integration point within the PeopleSoft system, various technologies are used to receive transactions into the PeopleSoft system.

This diagram illustrates the methods used to receive inbound transactions to PeopleSoft, including transactions processed by the PeopleSoft Integration Broker, electronic data collection, and system generated transactions. This diagram also displays the methods of data validation, error handling, and database updates:

This diagram illustrates the methods used to receive inbound transactions to PeopleSoft

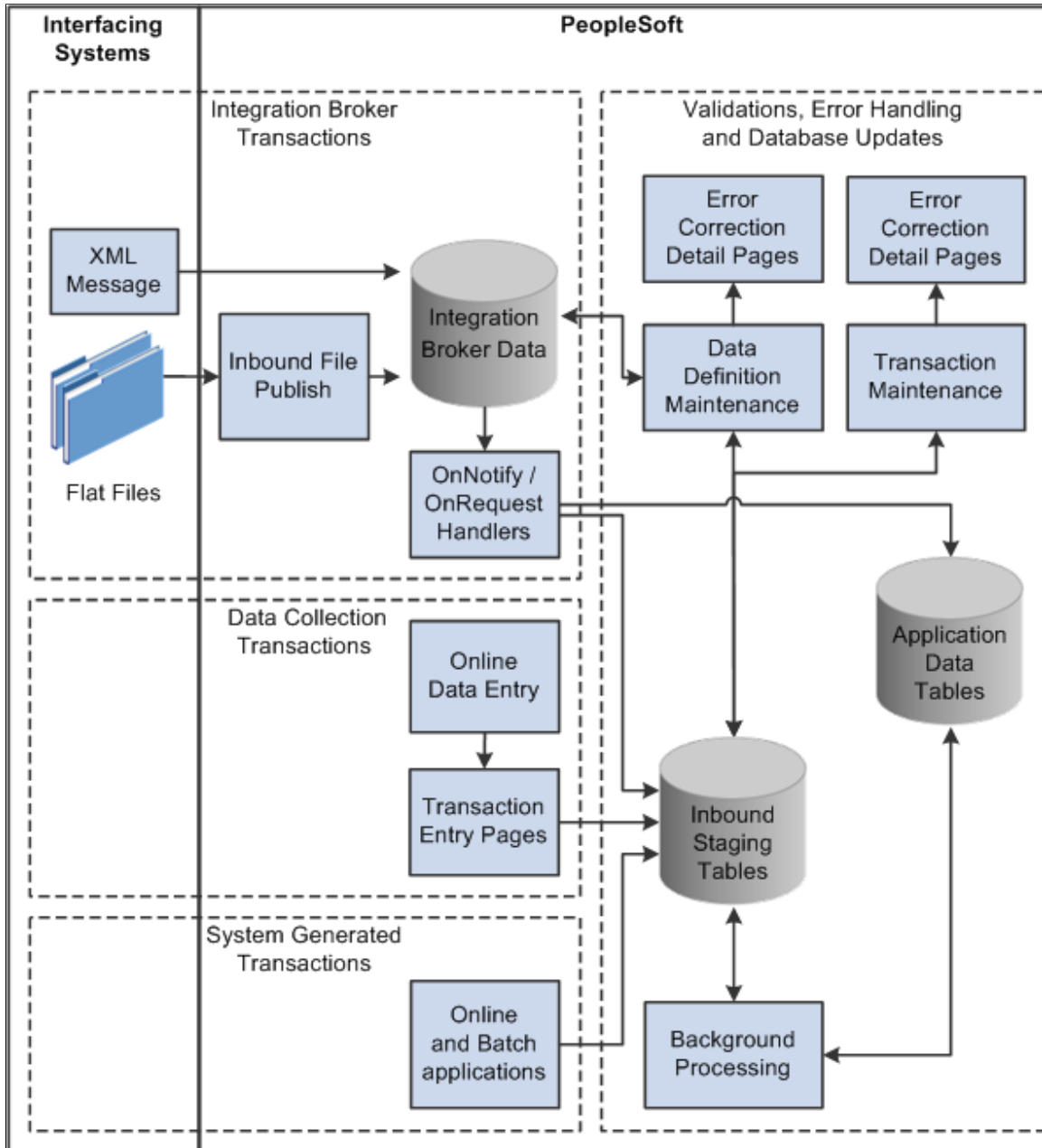

Integration Broker Based Transaction

The PeopleSoft Integration Broker provides a method for communications between external systems and PeopleSoft applications using industry standard XML-formatted transactions. Transactions are automatically loaded into the PeopleSoft system by handlers associated with each service operation. Once transactions have been loaded into the PeopleSoft system, you can view all transactions in the transaction log and access detail pages that enable you to correct transaction errors. Most asynchronous EIPs load data into staging tables where background programs validate and process individual transactions within the service operation instance.

The Inbound File Publish utility, which utilizes the File Layout Object tool, may also be used to automatically convert flat file input to XML-based service operations. Examples are provided showing

how to use this utility, and many PeopleSoft SCM electronic data interchange (EDI) transactions have been set up to take advantage of this feature.

See "PeopleSoft Electronic Data Interchange" (PeopleSoft Electronic Data Interchange).

Electronic Data Collection Transaction Pages

PeopleSoft SCM includes transaction pages for many of the inbound asynchronous transactions. The transaction pages are designed for quick data entry. There are minimal edits, and no application database updates are performed in these pages as the background programs scanning the transaction logs handle detail processing. The transaction pages provide a method of quick data entry for much of the transaction-based information processed by the system. You can enter the transactions directly onto the page, or attach a wedge and bar code reader to take advantage of bar code scanning benefits.

System-Generated Transactions

Several transactions that are fed in the transaction log are generated from internal application programs. By generating these transactions, applications push heavy processing functions to a background mode.

Validations, Error Handling, and Database Updates

Most inbound transactions, no matter which technology delivers them to the PeopleSoft system, are loaded into staging tables, where they are validated by background routines scanning these transaction logs awaiting incoming work. If errors are found, the transaction status in the transaction log is changed to *Error*, and rows are inserted into error tables for each error message.

Error messages appear on the Transaction Maintenance page for transactional type data such as, inventory adjustments and purchase order receipts. For definitional type data such as item master and bills of material, the Data Definition page is used to review and correct the erroneous information.

Once you have corrected the information and saved the page, the transaction is ready to be reprocessed.

Some transactions provide functionality to immediately validate and update application tables from subscription processes. For example, the Consumer and Par Location Count transactions both attempt to update the application tables, but if errors are found, the transactions write the data to the error tables so that corrections can be made.

PeopleTools: Integration Broker

Related Links

"PeopleSoft Electronic Data Interchange" (PeopleSoft Electronic Data Interchange)

[Understanding Electronic Data Collection](#)

"Issuing Material Using Electronic Data Collection" (PeopleSoft Manufacturing)

"Processing Picking Plans Using Electronic Data Collection" (PeopleSoft Manufacturing)

"Processing Kit Issues and Returns Using Electronic Data Collection" (PeopleSoft Manufacturing)

"Recording Completions Using Electronic Data Collection" (PeopleSoft Manufacturing)

"Processing Other Electronic Data Collection Transactions" (PeopleSoft Manufacturing)

[Transaction Maintenance Page](#)

[Data Def Maint Page](#)

PeopleSoft SCM Outbound EIPs

Outbound EIPs exist throughout the PeopleSoft system, providing interface points for third-party applications requiring information as activity occurs within the PeopleSoft system. Most of these integrations utilize PeopleSoft Integration Broker technology to format and send industry standard XML service operations. For example, as item master information is entered into PeopleSoft applications, the system uses XML-based service operations to notify third-party systems enabling them to use this information to maintain their own item master tables.

Understanding the Outbound Transaction Architecture

PeopleSoft SCM applications as well as interacting third-party systems have various processing and timing requirements that dictate when information can be generated or received. For this reason, the integration points provided by PeopleSoft utilize a number of different approaches when generating outbound service operations.

For example, a third-party system requiring item master information from the PeopleSoft Inventory application may want immediate incremental updates as information is changed online, or may want periodic updates on a nightly or weekly basis. The Item Master EIP provides both options, giving the third-party system the choice as to how it wants to receive this information.

Component or Incremental Publish

The system generates an incremental transaction immediately upon saving a component in various PeopleSoft applications. Components used to maintain information such as items or customers utilize the Component Publish approach.

Batch Publish

This diagram illustrates the batch publish process flow for outbound transactions. The Batch Publish Rules page is used to activate the batch publish rule for the service operations using the batch publish utility. Once PeopleSoft applications place transactions into the outbound staging tables, the Publish Outbound Message process retrieves the transaction data and calls the Batch Publish Utility to create XML or flat files for the receiving system:

This diagram illustrates the batch publish process flow for outbound transactions

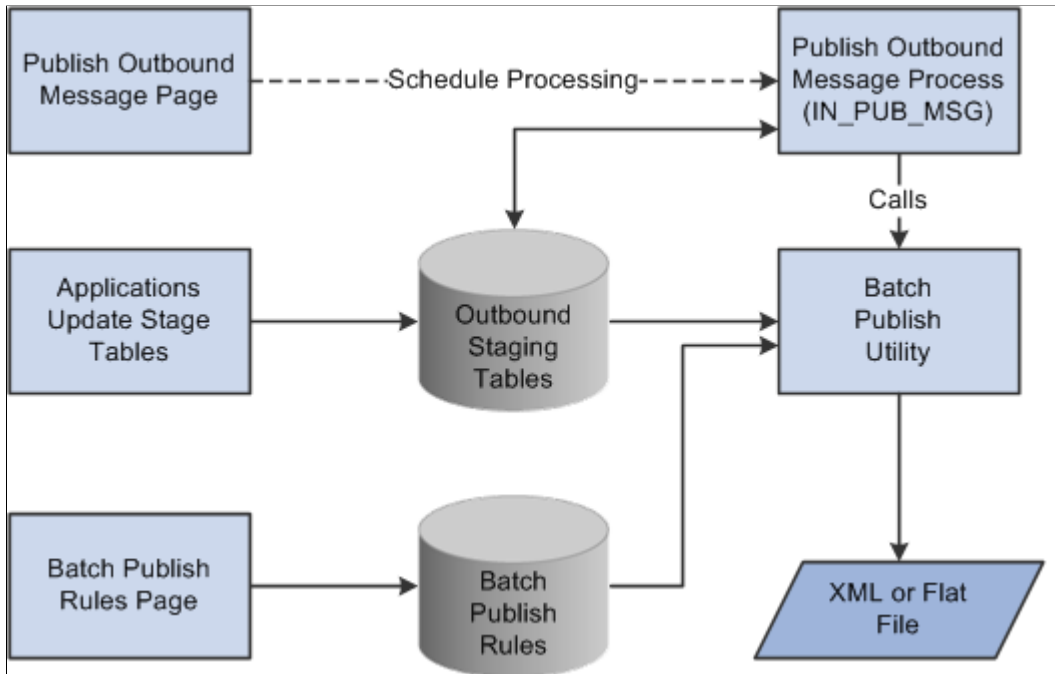

The Integration Broker enables grouping many like transactions into a single service operation. Background processes that work on batches of transactions at one time utilize this approach.

In addition, other processes use this approach where interface requirements demand various groupings of like transactions based on common information within each transaction. For example, an Advanced Shipping Notice service operation can be sent to a customer when the customer's order is shipped within the PeopleSoft Inventory system. This transaction may go directly to the customer or it may go through third-party software that converts the XML to one of the industry standard EDI formats, such as X.12, before passing it on to the customer. Using the options available with the Batch Publish approach, users can dictate whether to create a single service operation for all customers to send to the third-party software or create individual service operations to send directly to each customer.

PeopleSoft SCM applications all use the Publish Outbound Message process to initiate the Batch Publish of outbound EIPs. Built into this routine is the Batch Publish utility, a common PeopleSoft tool that provides the functionality to group and filter or chunk transactions as noted in the previous example.

The Batch Publish utility also provides the option to create flat files instead of XML-based output, when file layout objects exist for transactions being generated. File layout objects are easy to modify, and PeopleSoft provides examples for all transactions included in the EDI feature.

See "PeopleSoft Electronic Data Interchange" (PeopleSoft Electronic Data Interchange).

Full Data Replication

Full data replication is the process used to seed, or initially populate or repopulate, a copy of an entire table onto a remote database or legacy system. The entire contents of the table are published to all systems that require a copy of the table. Generally, full data replication occurs with setup tables, or, relatively static, low volume tables keyed by SetID.

Once a copy of the table exists, incremental updates provide a mechanism or process to keep the copy up-to-date with changes made on the master. Incremental updates occur most often with transaction tables, or frequently updated tables keyed by business unit.

Most full data replication service operation names end in `_FULLSYNC`.

Comprehensive List of SCM EIPs

PeopleSoft SCM provides a comprehensive group of inbound and outbound EIPs for you to use. This table lists all the EIPs delivered by SCM and provides cross reference information to the PeopleSoft applications that utilize that EIP.

Note: Some of the EIPs are shared by multiple SCM applications. Those EIPs that are shared are listed in the table under the primary application that maintains that EIP.

<i>PeopleSoft SCM Product</i>	<i>EIP</i>	<i>Object Name</i>	<i>Path</i>	<i>Type</i>	<i>Reference</i>
PeopleSoft Billing and PeopleSoft Order Management	Credit Card Authorize, Bill and Credit	CREDITCARD_TRANSACTION	Outbound	Sync	See "Understanding Credit Card Processing" (PeopleSoft Order to Cash Common Information).
PeopleSoft Billing	CRM 360 Degree View	BI_EIP360_REQ BI_EIP360_RSP	Inbound and Outbound	Sync	See "Activating the Service Operation" (PeopleSoft Billing).
PeopleSoft Billing	Billing Invoice	BILLING_INVOICE_NOTICE	Outbound	Async	See "Understanding EDI Transactions" (PeopleSoft Billing).
PeopleSoft Billing	Billing Invoice	EDI_TXN_810 Note: EDI_TXN_810 is the BILLING_INVOICE_NOTICE in X.12 EDI format.	Outbound	Async	See "Understanding EDI Transactions" (PeopleSoft Billing).
PeopleSoft Billing	Bill Source Fullsync	BILL_SOURCE_FULLSYNC	Outbound	Async	See "Setting up Bill Type, Bill Source, and Tax Header EIPs" (PeopleSoft Billing).

PeopleSoft SCM Product	EIP	Object Name	Path	Type	Reference
PeopleSoft Billing	Bill Source Sync	BILL_SOURCE_SYNC	Outbound	Async	See "Setting up Bill Type, Bill Source, and Tax Header EIPs" (PeopleSoft Billing).
PeopleSoft Billing	Bill Type Fullsync	BILL_TYPE_FULLSYNC	Outbound	Async	See "Setting up Bill Type, Bill Source, and Tax Header EIPs" (PeopleSoft Billing).
PeopleSoft Billing	Bill Type Sync	BILL_TYPE_SYNC	Outbound	Async	See "Setting up Bill Type, Bill Source, and Tax Header EIPs" (PeopleSoft Billing).
PeopleSoft Billing, Order Management, Purchasing, and Accounts Payable	Geocode Request	GET_GEOCODE_REQ GET_GEOCODE_RES Note: These EIPs can be used with any third-party tax calculation systems.	Inbound and Outbound	Sync	See Understanding PeopleSoft Integration With Taxware Enterprise .
PeopleSoft Billing and PeopleSoft Order Management	Tax Calculation	TAXWARE_CALCTAX	Outbound	Sync	See Understanding PeopleSoft Tax Solutions .
PeopleSoft Billing and PeopleSoft Order Management	Tax Calculation	VERTEX_CALCTAX	Outbound	Sync	See Understanding PeopleSoft Tax Solutions .
PeopleSoft Billing, Order Management, Purchasing, and Accounts Payable	Tax Calculation Request	DO_TAXCALC_REQ DO_TAXCALC_RES Note: These EIPs can be used with any third-party tax calculation systems.	Inbound and Outbound	Sync	See Understanding PeopleSoft Integration With Taxware Enterprise .

PeopleSoft SCM Product	EIP	Object Name	Path	Type	Reference
PeopleSoft Billing	Tax Code Fullsync	TAX_HEADER_TBL_FULLSYNC	Outbound	Async	See "Setting up Bill Type, Bill Source, and Tax Header EIPs" (PeopleSoft Billing).
PeopleSoft Billing and PeopleSoft Order Management	Tax Geocode	TAXWARE_GEOCODES	Outbound	Sync	See Associating Address Information with Geocodes .
PeopleSoft Billing and PeopleSoft Order Management	Tax Geocode	VERTEX_GEOCODES	Outbound	Sync	See Associating Address Information with Geocodes .
PeopleSoft Billing, Order Management, Purchasing, and Accounts Payable	Vertex Tax Area Request	GET_VERTEX_TAXAREA_REQ GET_VERTEX_TAXAREA_RES	Inbound and Outbound	Sync	See Understanding PeopleSoft Integration With Vertex O Series .
PeopleSoft Billing, Order Management, Purchasing, and Accounts Payable	Vertex Tax Calculation Request	DO_VERTEX_TAXCALC_REQ DO_VERTEX_TAXCALC_RES	Inbound and Outbound	Sync	See Understanding PeopleSoft Integration With Vertex O Series .
PeopleSoft Enterprise Pricer	Arbitration Plan	ARBITRATION_PLAN_FULLSYNC	Inbound and Outbound	Async	See "Understanding Pricing EIPs" (PeopleSoft Enterprise Pricer).
PeopleSoft Enterprise Pricer	Arbitration Plan	ARBITRATION_PLAN_SYNC	Inbound and Outbound	Async	See "Understanding Pricing EIPs" (PeopleSoft Enterprise Pricer).
PeopleSoft Enterprise Pricer	Price List	PRICE_LIST_DETAIL_FULLSYNC	Inbound and Outbound	Async	See "Understanding Pricing EIPs" (PeopleSoft Enterprise Pricer).

PeopleSoft SCM Product	EIP	Object Name	Path	Type	Reference
PeopleSoft Enterprise Pricer	Price List	PRICE_LIST_DETAIL_SYNC	Inbound and Outbound	Async	See "Understanding Pricing EIPs" (PeopleSoft Enterprise Pricer).
PeopleSoft Enterprise Pricer	Price List	PRICE_LIST_FULLSYNC	Inbound and Outbound	Async	See "Understanding Pricing EIPs" (PeopleSoft Enterprise Pricer).
PeopleSoft Enterprise Pricer	Price List	PRICE_LIST_HEADER_FULLSYNC	Inbound and Outbound	Async	See "Understanding Pricing EIPs" (PeopleSoft Enterprise Pricer).
PeopleSoft Enterprise Pricer	Price List	PRICE_LIST_HEADER_SYNC	Inbound and Outbound	Async	See "Understanding Pricing EIPs" (PeopleSoft Enterprise Pricer).
PeopleSoft Enterprise Pricer	Price List	PRICE_LIST_SYNC	Inbound and Outbound	Async	See "Understanding Pricing EIPs" (PeopleSoft Enterprise Pricer).
PeopleSoft Enterprise Pricer	Price Rule	PRICE_RULE_DATA_FULLSYNC	Inbound and Outbound	Async	See "Understanding Pricing EIPs" (PeopleSoft Enterprise Pricer).
PeopleSoft Enterprise Pricer	Price Rule	PRICE_RULE_DATA_SYNC	Inbound and Outbound	Async	See "Understanding Pricing EIPs" (PeopleSoft Enterprise Pricer).
PeopleSoft Enterprise Pricer	Price Rule	PRICE_RULE_KEYS_FULLSYNC	Inbound and Outbound	Async	See "Understanding Pricing EIPs" (PeopleSoft Enterprise Pricer).

PeopleSoft SCM Product	EIP	Object Name	Path	Type	Reference
PeopleSoft eProcurement	Direct Connect	PV_CXML1_ORDER	Outbound	Sync	See "Understanding Direct Connect Supplier Integration" (PeopleSoft eProcurement).
PeopleSoft eProcurement	Direct Connect	PV_CXML1_POOM	Outbound	Sync	See "Understanding Direct Connect Supplier Integration" (PeopleSoft eProcurement).
PeopleSoft eProcurement	Direct Connect	PV_CXML1_POSR	Outbound	Sync	See "Understanding Direct Connect Supplier Integration" (PeopleSoft eProcurement).
PeopleSoft eProcurement	ePro Availability Check	PV_AVAIL_CHECK_REQ PV_AVAIL_CHECK_RESP	Outbound	Sync	See "Using Price and Availability Check" (PeopleSoft eProcurement).
PeopleSoft eProcurement	Requisition Approval Email	PV_EMAIL_REQ_APPROVAL	Outbound	Async	See "Setting Up Email Approvals for PeopleSoft eProcurement" (PeopleSoft eProcurement).
PeopleSoft eProcurement	ePro Direct Connect	PV_DC_CONNECT_REQST PV_DC_CONNECT_RESP	Outbound	Sync	See "Setting Up PeopleSoft Integration Broker for Direct Connect" (PeopleSoft eProcurement).
PeopleSoft eProcurement	ePro Direct Connect	PV_ORDER_REQ PV_ORDER_RESP	Outbound	Sync	See "Activating Service Operations" (PeopleSoft eProcurement).
PeopleSoft eProcurement	ePro Order Status	PV_ORD_STS_REQ PV_ORD_STS_RESP	Outbound	Sync	See "Activating Service Operations" (PeopleSoft eProcurement).

PeopleSoft SCM Product	EIP	Object Name	Path	Type	Reference
PeopleSoft eProcurement	ePro Price Check	PV_PRICE_CHECK_REQ PV_PRICE_CHECK_RESP	Outbound	Sync	See "Activating Service Operations" (PeopleSoft eProcurement).
PeopleSoft eProcurement	ePro Procurement Order	PV_ORDER	Outbound	Async	See "Activating Service Operations" (PeopleSoft eProcurement).
PeopleSoft eProcurement	ePro xCBL Order	PV_ORDER_XCBL3	Outbound	Async	See "Setting Up Dynamic Dispatching" (PeopleSoft eProcurement).
PeopleSoft eProcurement	ePro Requisition Approval email	PV_EMAIL_REQ_APPROVAL	Inbound	Async	See <i>PeopleSoft Approval Framework</i>
PeopleSoft eProcurement	Marketplace Integration	PV_MS_PODISPATCH	Outbound	Sync	See "Understanding Direct Connect Supplier Integration" (PeopleSoft eProcurement).
PeopleSoft eProcurement	Marketplace Integration	PV_MS_RESP_MSG	Inbound	Async	See "Marketplace EIPs" (PeopleSoft eProcurement).
PeopleSoft Inventory	Advance Shipping Notice	ADVANCED_SHIPPING_NOTICE	Outbound	Async	See "Creating Advanced Shipping Notices" (PeopleSoft Inventory).
PeopleSoft Inventory	Consumer	CONSUMER_SYNC	Inbound	Async	See "Importing Consumer Information with the Consumer Message EIP" (PeopleSoft Inventory).
PeopleSoft Inventory	Consumer Usage	CONSUMER_USAGE	Outbound	Async	See "Exporting Consumer Usage Information" (PeopleSoft Inventory).

PeopleSoft SCM Product	EIP	Object Name	Path	Type	Reference
PeopleSoft Inventory and PeopleSoft Purchasing	Get PO IUT	GET_POIUT_INFO	Inbound	Sync	See "Purchase Order and InterUnit Transfer Information Business Interlink" (PeopleSoft Inventory).
PeopleSoft Inventory	GTIN Data Notification	GTIN_DATA_NOTIFICATION	Outbound	Async	See "Using Universal Item Identifiers" (PeopleSoft Managing Items).
PeopleSoft Inventory	Inventory Stock Level Inquiry	IN_STOCK_LEVELS	Outbound	Sync	See "Viewing Item Balances" (PeopleSoft Inventory).
PeopleSoft Inventory	Internal Location Expected Receipt	INTERNAL_LOC_EXPECTED_RECEIPT	Outbound	Async	See "Creating Internal Location Expected Receipts" (PeopleSoft Inventory).
PeopleSoft Inventory	Interunit Expected Receipt	INTERUNIT_EXPECTED_RECEIPT	Outbound	Async	See "Creating Interunit Expected Receipts" (PeopleSoft Inventory).
PeopleSoft Inventory	Interunit Receipt	INTERUNIT_RECEIPT	Inbound	Async	See "Staging Interunit Transfers Using an Electronic Data Collection System" (PeopleSoft Inventory).
PeopleSoft Inventory	Inventory Adjustment	INVENTORY_ADJUSTMENT	Inbound	Async	See "Making Adjustments Using the Inventory Adjustment EIP" (PeopleSoft Inventory).
PeopleSoft Inventory	Inventory Create Stock Request	INVENTORY_CREATE_STOCK_REQUEST	Inbound	Async	See "Creating Orders Using Data From a Third-Party System" (PeopleSoft Inventory).

PeopleSoft SCM Product	EIP	Object Name	Path	Type	Reference
PeopleSoft Inventory	Inventory Balance Notification	INV_BAL_NOTIF_BUS_UNIT	Outbound	Async	See "Providing Inventory Balances to Third-Party Systems" (PeopleSoft Inventory).
PeopleSoft Inventory	Inventory Balance Notification	INV_BAL_NOTIF_VENDOR	Outbound	Async	See "Providing Inventory Balances to Third-Party Systems" (PeopleSoft Inventory).
PeopleSoft Inventory	Inventory by Location	INVENTORY_BY_LOC_REQ INVENTORY_BY_LOC_RSP	Inbound	Sync	See "Providing Inventory Balances to Third-Party Systems" (PeopleSoft Inventory).
PeopleSoft Inventory	Inventory Freight Rate Request	INVENTORY_FREIGHT_RATE_REQUEST	Outbound	Sync	See "Enabling the PeopleSoft EIPs for Third-Party Freight" (PeopleSoft Supply Chain Management Common Information).
PeopleSoft Inventory	Inventory Freight Request	INVENTORY_FREIGHT_REQUEST	Outbound	Async	See "Enabling the PeopleSoft EIPs for Third-Party Freight" (PeopleSoft Supply Chain Management Common Information).
PeopleSoft Inventory	Inventory Freight Response	INVENTORY_FREIGHT_RESPONSE	Inbound	Async	See "Enabling the PeopleSoft EIPs for Third-Party Freight" (PeopleSoft Supply Chain Management Common Information).

PeopleSoft SCM Product	EIP	Object Name	Path	Type	Reference
PeopleSoft Inventory	Inventory Freight Ship Request	INVENTORY_FREIGHT_SHIP_REQUEST	Outbound	Sync	See "Enabling the PeopleSoft EIPs for Third-Party Freight" (PeopleSoft Supply Chain Management Common Information).
PeopleSoft Inventory	Inventory Front End Shipping	INVENTORY_FRONT_END_SHIPPING	Inbound	Async	See "Setting up the Fulfillment Engine EIPs" (PeopleSoft Inventory).
PeopleSoft Inventory	Inventory Pick Confirm	INVENTORY_PICK_CONFIRM	Inbound	Async	See "Setting up the Fulfillment Engine EIPs" (PeopleSoft Inventory).
PeopleSoft Inventory	Inventory Picking	INVENTORY_PICKING	Inbound	Async	See "Entering Picking Feedback Using an Electronic Data Collection System" (PeopleSoft Inventory).
PeopleSoft Inventory	Inventory Putaway	INVENTORY_PUTAWAY	Inbound	Async	See "Entering Stockroom Feedback Using an Electronic Data Collection System" (PeopleSoft Inventory).
PeopleSoft Inventory	Inventory Reservation	INVENTORY_RESERVATION	Inbound	Async	See "Setting up the Fulfillment Engine EIPs" (PeopleSoft Inventory).
PeopleSoft Inventory	Inventory Shipping	INVENTORY_SHIPPING	Inbound	Async	See "Setting up the Fulfillment Engine EIPs" (PeopleSoft Inventory).

PeopleSoft SCM Product	EIP	Object Name	Path	Type	Reference
PeopleSoft Inventory	Inventory Shipping Container	INVENTORY_SHIP_CNTR	Inbound	Async	See "Working with Shipping Containers and Shipping Serial IDs Using an Electronic Data Collection System" (PeopleSoft Inventory).
PeopleSoft Inventory	Inventory Shipping Serial ID	INVENTORY_SHIP_SERIAL	Inbound	Async	See "Working with Shipping Containers and Shipping Serial IDs Using an Electronic Data Collection System" (PeopleSoft Inventory).
PeopleSoft Inventory	Inventory Transfer	INVENTORY_TRANSFER	Inbound	Async	See "Transferring Materials Using the Inventory Transfer EIP" (PeopleSoft Inventory).
PeopleSoft Inventory	Work Order Issues Component Interface	INVENTORY_WO_ISSUES	Inbound	Sync	See "Using the Inventory Work Order Issues Service Operation and Component Interface" (PeopleSoft Inventory).
PeopleSoft Inventory	Item Master	ITEM_CRM_FULLSYNC_EFF	Outbound	Async	See "Understanding Item Loading" (PeopleSoft Managing Items).
PeopleSoft Inventory	Item Master	ITEM_CRM_SYNC	Outbound	Async	See "Understanding Item Loading" (PeopleSoft Managing Items).
PeopleSoft Inventory	Item Master	ITEM_CRM_SYNC_EFF	Outbound	Async	See "Understanding Item Loading" (PeopleSoft Managing Items).

PeopleSoft SCM Product	EIP	Object Name	Path	Type	Reference
PeopleSoft Inventory	Item Master	ITEM_FULLSYNC	Inbound and Outbound	Async	See "Understanding Item Price List and Item Master EIPs" (PeopleSoft Managing Items).
PeopleSoft Inventory	Item Master	ITEM_FULLSYNC_EFF	Outbound	Async	See "Understanding Item Price List and Item Master EIPs" (PeopleSoft Managing Items).
PeopleSoft Inventory and PeopleSoft Manufacturing	Item Master	ITEM_SYNC	Inbound	Async	See "Understanding Item Price List and Item Master EIPs" (PeopleSoft Managing Items). See "Understanding the PDX Integration" (PeopleSoft Manufacturing).
PeopleSoft Inventory and PeopleSoft Manufacturing	Item Master	ITEM_SYNC PDX_MSG <hr/> Note: PDX_MSG allows inbound integration using Agile PDX format <hr/>	Outbound	Async	See "Understanding Item Price List and Item Master EIPs" (PeopleSoft Managing Items). See "Understanding Item Loading" (PeopleSoft Managing Items). See "Understanding the PDX Integration" (PeopleSoft Manufacturing).

PeopleSoft SCM Product	EIP	Object Name	Path	Type	Reference
PeopleSoft Inventory	Item Master	ITEM_SYNC_EFF	Outbound	Async	See "Understanding Item Price List and Item Master EIPs" (PeopleSoft Managing Items). See "Understanding Item Loading" (PeopleSoft Managing Items).
PeopleSoft Inventory and PeopleSoft Purchasing	Item Price List	ITEM_PRICELIST_LOAD	Inbound	Async	See "Understanding Item Price List and Item Master EIPs" (PeopleSoft Managing Items).
PeopleSoft Inventory	Par Location	PAR_LOCATION_FULLSYNC	Outbound	Async	See "Counting Par Location Inventory" (PeopleSoft Inventory).
PeopleSoft Inventory	Par Location	PAR_LOCATION_SYNC	Outbound	Async	See "Counting Par Location Inventory" (PeopleSoft Inventory).
PeopleSoft Inventory	Par Location Count	PAR_LOCATION_COUNT	Inbound	Async	See "Sending and Receiving Data Using the EIP-Based Counting Method" (PeopleSoft Inventory).
PeopleSoft Inventory	Physical Inventory	PHYSICAL_INVENTORY	Inbound	Async	See "Collecting Counting Data using the Physical Inventory EIP" (PeopleSoft Inventory).
PeopleSoft Inventory	Product Availability	PSPRODAVAIL	Sync	Inbound	See "Providing Item Availability Checks to Third-Party Systems" (PeopleSoft Inventory).

PeopleSoft SCM Product	EIP	Object Name	Path	Type	Reference
PeopleSoft Inventory	Product Availability Inquiry	PRODUCT_AVAAILABILITY PRODUCT_AVAAILABILITY	Outbound	Sync	See "Providing Item Availability Checks to Third-Party Systems" (PeopleSoft Inventory).
PeopleSoft Inventory	Returned Material Authorization	RMA_LOAD	Inbound	Async	See "Staging Interunit Transfer and RMA Receipts" (PeopleSoft Inventory).
PeopleSoft Inventory	Shipping Order Release	SHIPPING_ORDER_RELEASE	Outbound	Async	See "Creating Shipping Order Release EIPs" (PeopleSoft Inventory).
PeopleSoft Inventory	Shipping Notification	SHIPPING_NOTIFICATION	Inbound	Async	See "EIPs for Fulfillment Transactions" (PeopleSoft Inventory).
PeopleSoft Inventory	Transportation Notification	TMS_LOAD_NOTIFICATION	Inbound	Async	See "Transportation Management System EIPs" (PeopleSoft Inventory).
PeopleSoft Inventory	Transportation Notification	TMS_LOAD_NOTIFICATION TMS_LOAD_NOTIFICATION_RESP	Inbound	Sync	See "Transportation Management System EIPs" (PeopleSoft Inventory).
PeopleSoft Inventory	Transportation Order	TMS_ORDER_RELEASE	Outbound	Async	See "Transportation Management System EIPs" (PeopleSoft Inventory).
PeopleSoft Inventory	VMI Expected Receipts	VMI_EXPECTED_RECEIPT	Outbound	Async	See "Creating and Using VMI Enterprise Integration Points" (PeopleSoft Inventory).

PeopleSoft SCM Product	EIP	Object Name	Path	Type	Reference
PeopleSoft Inventory	VMI Interunit Receipt	VMI_INTERUNIT_RECEIPT	Inbound	Async	See "Creating and Using VMI Enterprise Integration Points" (PeopleSoft Inventory).
PeopleSoft Inventory	VMI Inventory Adjustment	VMI_INVENTORY_ADJUSTMENT	Inbound	Async	See "Creating and Using VMI Enterprise Integration Points" (PeopleSoft Inventory).
PeopleSoft Inventory	VMI Quantity on Hand	VMI_QUANTITY_ON_HAND	Inbound	Async	See "Creating and Using VMI Enterprise Integration Points" (PeopleSoft Inventory).
PeopleSoft Manufacturing	Actual Hours	PRODUCTION_ACTUAL_HOURS	Inbound	Async	See "Recording and Viewing Actual Machine and Labor Hours" (PeopleSoft Manufacturing).
PeopleSoft Manufacturing	Bill of Material	BOM_SYNC	Inbound	Async	See "Importing Bills of Material from External Sources" (PeopleSoft Manufacturing). See "Understanding the PDX Integration" (PeopleSoft Manufacturing).
PeopleSoft Manufacturing	Production Completions	PRODUCTION_ORDER_COMPLETION	Inbound	Async	See "Processing Electronic Data Collection Completions Transactions" (PeopleSoft Manufacturing).

PeopleSoft SCM Product	EIP	Object Name	Path	Type	Reference
PeopleSoft Manufacturing	Production Order Issue	PRODUCTION_ORDER_ISSUE	Inbound	Async	See "Understanding the Process of Recording Completions and Scrap Using Electronic Data Collection" (PeopleSoft Manufacturing).
PeopleSoft Manufacturing	Production Order Update	PRODUCTION_ORDER_UPDATE	Outbound	Async	See "Understanding Production IDs and Production Schedules" (PeopleSoft Manufacturing).
PeopleSoft Manufacturing	Production Picking	PRODUCTION_PICKING	Inbound	Async	See "Processing Picking Plans Using Electronic Data Collection" (PeopleSoft Manufacturing).
PeopleSoft Manufacturing	Production Serial Association	PRODUCTION_SERIAL_ASSOCIATION	Inbound	Async	See "Understanding Serial Genealogy" (PeopleSoft Manufacturing).
PeopleSoft Order Management	Carrier/Shipping Method	CARRIER_FULLSYNC	Outbound	Async	See "Establishing Carriers" (Application Fundamentals).
PeopleSoft Order Management	Carrier/Shipping Method	CARRIER_FULLSYNC_EFF	Outbound	Async	See "Establishing Carriers" (Application Fundamentals).
PeopleSoft Order Management	Carrier/Shipping Method	CARRIER_SYNC	Inbound and Outbound	Async	See "Establishing Carriers" (Application Fundamentals).
PeopleSoft Order Management	Carrier/Shipping Method	CARRIER_SYNC_EFF	Outbound	Async	See "Establishing Carriers" (Application Fundamentals).

PeopleSoft SCM Product	EIP	Object Name	Path	Type	Reference
PeopleSoft Order Management	Contact	CONTACT_FULLSYNC	Inbound and Outbound	Async	See "Setting Up and Maintaining Contacts" (PeopleSoft Order to Cash Common Information).
PeopleSoft Order Management	Contact	CONTACT_FULLSYNC_EFF	Outbound	Async	See "Setting Up and Maintaining Contacts" (PeopleSoft Order to Cash Common Information).
PeopleSoft Order Management	Contact	CONTACT_SYNC	Inbound and Outbound	Async	See "Setting Up and Maintaining Contacts" (PeopleSoft Order to Cash Common Information).
PeopleSoft Order Management	Contact	CONTACT_SYNC_EFF	Outbound	Async	See "Setting Up and Maintaining Contacts" (PeopleSoft Order to Cash Common Information).
PeopleSoft Order Management	Contact	CONTACT_SYNC_REQ CONTACT_SYNC_REQ_CALLBACK	Inbound	Async Req/Rsp	See "Setting Up and Maintaining Contacts" (PeopleSoft Order to Cash Common Information).
PeopleSoft Order Management	Customer	CUSTOMER_FULLSYNC	Inbound and Outbound	Async	See "Adding General Customer Information" (PeopleSoft Order to Cash Common Information).
PeopleSoft Order Management	Customer	CUSTOMER_FULLSYNC_EFF	Outbound	Async	See "Adding General Customer Information" (PeopleSoft Order to Cash Common Information).

PeopleSoft SCM Product	EIP	Object Name	Path	Type	Reference
PeopleSoft Order Management	Customer	CUSTOMER_SYNC	Inbound and Outbound	Async	See "Adding General Customer Information" (PeopleSoft Order to Cash Common Information).
PeopleSoft Order Management	Customer	CUSTOMER_SYNC_EFF	Outbound	Async	See "Adding General Customer Information" (PeopleSoft Order to Cash Common Information).
PeopleSoft Order Management	Customer	CUSTOMER_SYNC_REQ CUSTOMER_SYNC_REQ_CALLBACK	Inbound	Async Req/Rsp	See "Adding General Customer Information" (PeopleSoft Order to Cash Common Information).
PeopleSoft Order Management	Customer Group	CUSTOMER_GROUP_FULLSYNC	Inbound and Outbound	Async	See "Adding General Customer Information" (PeopleSoft Order to Cash Common Information).
PeopleSoft Order Management	Customer Group	CUSTOMER_GROUP_FULLSYNC_EFF	Outbound	Async	See "Adding General Customer Information" (PeopleSoft Order to Cash Common Information).
PeopleSoft Order Management	Customer Group	CUSTOMER_GROUP_SYNC	Inbound and Outbound	Async	See "Adding General Customer Information" (PeopleSoft Order to Cash Common Information).
PeopleSoft Order Management	Customer Group	CUSTOMER_GROUP_SYNC_EFF	Outbound	Async	See "Adding General Customer Information" (PeopleSoft Order to Cash Common Information).

PeopleSoft SCM Product	EIP	Object Name	Path	Type	Reference
PeopleSoft Order Management	Customer Group	CUSTOMER_GROUP_SYNC_REQ CUSTOMER_GROUP_SYNC_REQ_CALLBACK	Inbound	Async Req/Rsp	See "Adding General Customer Information" (PeopleSoft Order to Cash Common Information).
PeopleSoft Order Management	Order Status	OrderTracking	Inbound	Sync	<i>PeopleSoft CRM Sales Force Automation</i>
PeopleSoft Order Management	Product	PRODUCT_FULLSYNC	Inbound and Outbound	Async	See "Understanding Product Load EIPs" (PeopleSoft Order to Cash Common Information).
PeopleSoft Order Management	Product	PRODUCT_FULLSYNC_EFF	Outbound	Async	See "Understanding Product Load EIPs" (PeopleSoft Order to Cash Common Information).
PeopleSoft Order Management	Product	PRODUCT_SYNC	Inbound and Outbound	Async	See "Understanding Product Load EIPs" (PeopleSoft Order to Cash Common Information).
PeopleSoft Order Management	Product	PRODUCT_SYNC_EFF	Outbound	Async	See "Understanding Product Load EIPs" (PeopleSoft Order to Cash Common Information).
PeopleSoft Order Management	Product Group	PRODUCT_GROUP_FULLSYNC	Inbound and Outbound	Async	See "Understanding Product Load EIPs" (PeopleSoft Order to Cash Common Information).

PeopleSoft SCM Product	EIP	Object Name	Path	Type	Reference
PeopleSoft Order Management	Product Group	PRODUCT_GROUP_FULLSYNC_EFF	Outbound	Async	See "Understanding Product Load EIPs" (PeopleSoft Order to Cash Common Information).
PeopleSoft Order Management	Product Group	PRODUCT_GROUP_SYNC	Inbound and Outbound	Async	See "Understanding Product Load EIPs" (PeopleSoft Order to Cash Common Information).
PeopleSoft Order Management	Product Group	PRODUCT_GROUP_SYNC_EFF	Outbound	Async	See "Understanding Product Load EIPs" (PeopleSoft Order to Cash Common Information).
PeopleSoft Order Management	Product Price List/Catalog	PRODUCT_PRICELIST_SYNC	Outbound	Async	See "Understanding Sales Order and Quotation EIPs in PeopleSoft Order Management" (PeopleSoft Order Management).
PeopleSoft Order Management	Sales Order	SALES_ORDER_LOAD	Inbound	Async	See "Understanding Sales Order and Quotation EIPs in PeopleSoft Order Management" (PeopleSoft Order Management).
PeopleSoft Order Management	Sales Order/Quote Status	SALES_ORDER_STATUS	Outbound	Async	See "Understanding Sales Order and Quotation EIPs in PeopleSoft Order Management" (PeopleSoft Order Management).

PeopleSoft SCM Product	EIP	Object Name	Path	Type	Reference
PeopleSoft Order Management	Sales Order Acknowledgement	SALES_ORDER_ACKNOWLEDGEMENT	Outbound	Async	See "Understanding Sales Order and Quotation EIPs in PeopleSoft Order Management" (PeopleSoft Order Management).
PeopleSoft Order Management	Sales Order Change	SALES_CRM_ORDER_CHANGE_LOAD	Inbound	Async	See "Understanding Sales Order and Quotation EIPs in PeopleSoft Order Management" (PeopleSoft Order Management).
PeopleSoft Order Management	Sales Order Change	SALES_ORDER_CHANGE_LOAD	Inbound	Async	See "Understanding Sales Order and Quotation EIPs in PeopleSoft Order Management" (PeopleSoft Order Management).
PeopleSoft Order Management	Sales Order Load	SALES_CRM_ORDER_LOAD	Inbound	Async	See "Understanding Sales Order and Quotation EIPs in PeopleSoft Order Management" (PeopleSoft Order Management).
PeopleSoft Order Management	Sales Order Notice	SALES_ORDER_CHANGE_NOTICE	Outbound	Async	See "Understanding Sales Order and Quotation EIPs in PeopleSoft Order Management" (PeopleSoft Order Management).
PeopleSoft Order Management	Sales Quote	SALES_QUOTE_LOAD	Inbound	Async	See "Understanding Sales Order and Quotation EIPs in PeopleSoft Order Management" (PeopleSoft Order Management).

PeopleSoft SCM Product	EIP	Object Name	Path	Type	Reference
PeopleSoft Order Management	Sales Quote Load	SALES_CRM_QUOTE_LOAD	Inbound	Async	See "Understanding Sales Order and Quotation EIPs in PeopleSoft Order Management" (PeopleSoft Order Management).
PeopleSoft Order Management	Sales Quote Notice	SALES_QUOTE_NOTICE	Outbound	Async	See "Understanding Sales Order and Quotation EIPs in PeopleSoft Order Management" (PeopleSoft Order Management).
PeopleSoft Order Management	Standard Note	STD_NOTE_FULLSYNC	Inbound and Outbound	Async	See "Standard Notes Page" (PeopleSoft Order to Cash Common Information).
PeopleSoft Order Management	Standard Note	STD_NOTE_FULLSYNC_EFF	Outbound	Async	See "Standard Notes Page" (PeopleSoft Order to Cash Common Information).
PeopleSoft Order Management	Standard Note	STD_NOTE_SYNC	Inbound and Outbound	Async	See "Standard Notes Page" (PeopleSoft Order to Cash Common Information).
PeopleSoft Order Management	Standard Note	STD_NOTE_SYNC_EFF	Outbound	Async	See "Standard Notes Page" (PeopleSoft Order to Cash Common Information).

PeopleSoft SCM Product	EIP	Object Name	Path	Type	Reference
PeopleSoft Order Management	X.12 EDI Sales Order	EDI_TXN_850	Inbound	Async	See "Understanding Sales Order and Quotation EIPs in PeopleSoft Order Management" (PeopleSoft Order Management).
PeopleSoft Order Management	X.12 EDI Sales Order Acknowledgement	EDI_TXN_855	Outbound	Async	See "Understanding Sales Order and Quotation EIPs in PeopleSoft Order Management" (PeopleSoft Order Management).
PeopleSoft Order Management	X.12 EDI Sales Quote	EDI_TXN_840	Inbound	Async	See "Understanding Sales Order and Quotation EIPs in PeopleSoft Order Management" (PeopleSoft Order Management).
PeopleSoft Order Management	X.12 EDI Sales Quote Acknowledgement	EDI_TXN_845	Outbound	Async	See "Understanding Sales Order and Quotation EIPs in PeopleSoft Order Management" (PeopleSoft Order Management).
PeopleSoft Purchasing	Advanced Shipping Receipt	ADVANCED_SHIPPING_RECEIPT	Inbound	Async	See "Understanding the Receiving Business Process" (PeopleSoft Purchasing).
PeopleSoft Purchasing	GPO Item Load	ITEM_MFG_GPO_LOAD	Inbound	Async	See "Loading GPO Data Using PeopleSoft Integration Broker" (PeopleSoft Purchasing).

PeopleSoft SCM Product	EIP	Object Name	Path	Type	Reference
PeopleSoft Purchasing	CRM integration of IT Assets	MANUFACTURER_FULLSYNC	Outbound	Async	See <i>PeopleSoft CRM 9 Product and Item Management</i>
PeopleSoft Purchasing	Procurement Cards	PROCUREMENT_CARD_LOAD	Inbound	Async	See "Understanding the Procurement Card Business Process" (PeopleSoft Purchasing).
PeopleSoft Purchasing	Purchase Order Acknowledgement, PO Change Acknowledgement	PURCHASE_ORDER_ACKNOWLEDGEMENT	Inbound	Async	See "Understanding the Purchase Order Change Order Business Process" (PeopleSoft Purchasing).
PeopleSoft Purchasing	Purchase Order Dispatch	PURCHASE_ORDER_DISPATCH	Outbound	Async	See "Understanding Purchase Order Dispatch" (PeopleSoft Purchasing).
PeopleSoft Purchasing	Purchase Order Approval Email	PO_EMAIL_PO_APPROVAL	Outbound	Async	See "Setting Up Email Approvals for PeopleSoft Purchasing" (PeopleSoft Purchasing).
PeopleSoft Purchasing	Purchase Order Expected Receipt	PO_EXPECTED_RECEIPT_BUS_UNIT	Outbound	Async	See "Understanding the Receiving Business Process" (PeopleSoft Purchasing).
PeopleSoft Purchasing	Purchase Order Expected Receipt	PO_EXPECTED_RECEIPT_SHIPTO	Outbound	Async	See "Understanding the Receiving Business Process" (PeopleSoft Purchasing).

PeopleSoft SCM Product	EIP	Object Name	Path	Type	Reference
PeopleSoft Purchasing	Purchase Order Receipt	PO_RECEIPT_NOTIFICATION	Outbound	Aysnc	See "Understanding the Receiving Business Process" (PeopleSoft Purchasing). See Understanding POU Supplier Systems .
PeopleSoft Purchasing	Purchase Order Receipt	PURCHASE_ORDER_RECEIPT	Inbound	Async	See "Understanding the Receiving Business Process" (PeopleSoft Purchasing).
PeopleSoft Purchasing	Purchase Order Requisition	PURCHASE_REQUISITION_LOAD	Inbound	Async	See "Understanding the Purchasing Requisition Loader Application Engine Process (PO_REQLOAD)" (PeopleSoft Purchasing). See . See Understanding POU Supplier Systems . See Understanding SRS Applications .
PeopleSoft Purchasing	Purchase Order Requisition	PURCHASE_REQUISITION_LOAD_CRM	Inbound	Async	See "Understanding the Purchasing Requisition Loader Application Engine Process (PO_REQLOAD)" (PeopleSoft Purchasing).
PeopleSoft Purchasing	Request for Quote	PO_REQUEST_FOR_QUOTE	Outbound	Async	See "Understanding RFQs in PeopleSoft Purchasing" (PeopleSoft Purchasing).

PeopleSoft SCM Product	EIP	Object Name	Path	Type	Reference
PeopleSoft Purchasing	Request for Quote	PO_REQUEST_FOR_QUOTE_RESPONSE	Inbound	Async	See "Understanding RFQs in PeopleSoft Purchasing" (PeopleSoft Purchasing).
PeopleSoft Purchasing	Return to Vendor	RETURN_TO_VENDOR	Outbound	Async	See "Understanding the RTV Business Process" (PeopleSoft Purchasing).
PeopleSoft Quality	Quality Data Submit	QUALITY_DATA_SUBMIT	Inbound	Async	See Understanding SRS Applications .
PeopleSoft Services Procurement	Establishment and Location Full Sync (SCM to HCM)	ESTAB_LOC_US_FULLSYNC	Inbound and Outbound	Async	See "Setting Up Human Capital Management and Services Procurement Person Integration" (PeopleSoft Services Procurement).
PeopleSoft Services Procurement	US Establishment and Location Sync Message (SCM to HCM)	ESTAB_LOC_US_SYNC	Inbound and Outbound	Async	See "Setting Up Human Capital Management and Services Procurement Person Integration" (PeopleSoft Services Procurement).
PeopleSoft Services Procurement	Establishment FullSync Message (SCM to HCM)	ESTAB_TBL_FULLSYNC	Inbound and Outbound	Async	See "Setting Up Human Capital Management and Services Procurement Person Integration" (PeopleSoft Services Procurement).

PeopleSoft SCM Product	EIP	Object Name	Path	Type	Reference
PeopleSoft Services Procurement	Establishment Table Sync Message (SCM to HCM)	ESTAB_TBL_SYNC	Inbound and Outbound	Async	See "Setting Up Human Capital Management and Services Procurement Person Integration" (PeopleSoft Services Procurement).
PeopleSoft Services Procurement	Add Job (from HCM to SCM)	HCR_ADD_JOB	Outbound	Async	See "Setting Up Human Capital Management and Services Procurement Person Integration" (PeopleSoft Services Procurement).
PeopleSoft Services Procurement	Add Job (from SCM to HCM)	HCR_ADD_JOB_ACK	Inbound	Async	See "Setting Up Human Capital Management and Services Procurement Person Integration" (PeopleSoft Services Procurement).
PeopleSoft Services Procurement	Add Person (from SCM to HCM)	HCR_ADD_PERSON	Outbound	Async	See "Setting Up Human Capital Management and Services Procurement Person Integration" (PeopleSoft Services Procurement).
PeopleSoft Services Procurement	Add Job (from HCM to SCM)	HCR_ADD_PERSON_ACK	Inbound	Async	See "Setting Up Human Capital Management and Services Procurement Person Integration" (PeopleSoft Services Procurement).

PeopleSoft SCM Product	EIP	Object Name	Path	Type	Reference
PeopleSoft Services Procurement	Add User Profile	HCR_ADD_USER_PROFILE	Outbound	Async	See "Setting Up Service Operations - Incremental Synchronization" (PeopleSoft Services Procurement).
PeopleSoft Services Procurement	Add User Profile Acknowledgement	HCR_ADD_USER_PROFILE_ACK	Inbound	Async	See "Setting Up Service Operations - Incremental Synchronization" (PeopleSoft Services Procurement).
PeopleSoft Services Procurement	Add Job Canceled (from HCM to SCM)	HCR_CAN_JOB	Outbound	Async	See "Setting Up Human Capital Management and Services Procurement Person Integration" (PeopleSoft Services Procurement).
PeopleSoft Services Procurement	Labor Agreement Full Sync Message	HR_LABOR_AGRMNT_FULLSYNC	Inbound	Async	See "Setting Up Human Capital Management and Services Procurement Person Integration" (PeopleSoft Services Procurement).
PeopleSoft Services Procurement	Labor Agreement (from HCM to SCM)	HR_LABOR_AGRMNT_SYNC	Inbound	Async	See "Setting Up Human Capital Management and Services Procurement Person Integration" (PeopleSoft Services Procurement).
PeopleSoft Services Procurement	Candidate Req	SAC_CANDIDATE_REQ SAC_CANDIDATE_RESP	Outbound	Sync	See "Setting Up Human Capital Management and Services Procurement Person Integration" (PeopleSoft Services Procurement).

PeopleSoft SCM Product	EIP	Object Name	Path	Type	Reference
PeopleSoft Services Procurement	Job Posting	SAC_JOB_POST SAC_JOB_RESP	Inbound	Sync	See "Setting Up Human Capital Management and Services Procurement Person Integration" (PeopleSoft Services Procurement).
PeopleSoft Services Procurement	Job Unposted	SAC_JOB_UNPOST SAC_JOB_RESP	Inbound	Sync	See "Setting Up Human Capital Management and Services Procurement Person Integration" (PeopleSoft Services Procurement).
PeopleSoft Supplier Contract Management	Contract Activity Update	CS_ACTIVITY_CNTRCT	Inbound and Outbound	Async	See "Contract Syndication Enterprise Integration Points" (PeopleSoft Supplier Contract Management).
PeopleSoft Supplier Contract Management	Contract Syndication	CS_PROCUREMENT_CNTRCT	Inbound and Outbound	Async	See "Contract Syndication Enterprise Integration Points" (PeopleSoft Supplier Contract Management).
Common	EWN Notify Message	SAC_EWN_NOTIFY_MSG	Outbound	Async	See <i>PeopleSoft Events and Warnings</i>

For technical details about an individual EIP, use the Interactive Services Repository (ISR) in the My Oracle Support website located at <https://support.oracle.com/CSP/ui/flash.html>.

PeopleTools: PeopleCode API Reference

Implementing Integrations

Setting Up Service Operations

PeopleSoft is delivered with many enterprise integration points (EIPs) to send and receive data with a third-party system or another PeopleSoft application, such as CRM. These EIPs are implemented using service operations within PeopleSoft Integration Broker. The instructions in this section describe the steps necessary to enable service operations.

See [Understanding This Troubleshooting](#).

Note: Your database administrator will need to assist you with this setup.

Understanding Inbound EIPs

PeopleSoft Integration Broker can receive data from a third-party system or another PeopleSoft system, such as CRM. The inbound data can have the following data formats:

- An XML file that uses the PeopleSoft format.

This XML file could be generated by another PeopleSoft system, generated by a third-party system in this PeopleSoft XML format, or generated by a third-party system and then converted to the PeopleSoft XML format by a middleware product. Once received by your PeopleSoft system, the inbound data is placed in the message queue, checked for errors and then moved to the inbound staging tables to be processed by the individual PeopleSoft application.

- A flat file that uses the PeopleSoft format.

This file could be generated by a third-party system in this PeopleSoft format or generated by a third-party system and then converted to the PeopleSoft format by a middleware product. A flat file could also come from another PeopleSoft system. The PeopleSoft Integration Broker uses transforms to convert the data from a flat file to an XML file also using the PeopleSoft format. The inbound data is then placed in the message queue, checked for errors, and then moved to the inbound staging tables to be processed by the individual PeopleSoft application.

- A flat file using an EDI X.12 format.

This file could be generated by a third-party system in this EDI X.12 flat file format or generated by a third-party system and then converted to the EDI X.12 flat file format by a middleware product. An EDI flat file could also come from another PeopleSoft system. Once received by your PeopleSoft system, the PeopleSoft Integration Broker uses transforms to convert the data from a flat file to an XML file and then from EDI X.12 format to the PeopleSoft format. The inbound PeopleSoft-formatted XML data is then placed in the message queue, checked for errors, and then moved to the inbound staging tables to be processed by the individual PeopleSoft application.

- An XML file using an EDI X.12 format.

This file could be generated by a third-party system in this EDI X.12 XML format or generated by a third-party system and then converted to the EDI X.12 XML format by a middleware product. An EDI XML file could also come from another PeopleSoft system. Once received by your PeopleSoft system, the PeopleSoft Integration Broker uses transforms to convert the data from EDI X.12 format to the PeopleSoft format. The inbound PeopleSoft-formatted XML data is then placed in the message queue, checked for errors, and then moved to the inbound staging tables to be processed by the individual PeopleSoft application.

Note: Standard X.12 transaction definitions are predefined in PeopleSoft along with examples of transformation rules for selected X.12 transactions. Individual trading partner specifications will vary so customizations are required for each transaction or trading partner variation.

Understanding Outbound EIPs

PeopleSoft Integration Broker can send data to a third-party system or another PeopleSoft system, such as CRM using the following data formats:

- An XML file that uses the PeopleSoft format.

PeopleSoft can generate a PeopleSoft-formatted XML file to be received by another PeopleSoft system, such as CRM, or a third-party system with or without conversion by a middleware product.

- A flat file that uses the PeopleSoft format.

PeopleSoft can generate a PeopleSoft-formatted XML file that is converted, by PeopleSoft Integration Broker, into a PeopleSoft-formatted flat file. This flat file can be received by a third-party system or processed by a middleware product and then received by a third-party system.

- A flat file using an EDI X.12 format.

PeopleSoft can generate a PeopleSoft-formatted XML file that is converted, by PeopleSoft Integration Broker, using two transforms (Application Engine programs). The data is first converted into the EDI X.12 format and then from XML to flat file format.

- An XML file using an EDI X.12 format.

You do not have to use a flat file for EDI formatted data. As delivered, the PeopleSoft Integration Broker converts the PeopleSoft-formatted XML data into a EDI X.12 formatted flat file using transform programs; first by converting to an EDI XML format and then to a flat file format. However, you can change the system to output EDI X.12 data in an XML format by removing the second transform program.

Note: Standard X.12 transaction definitions are predefined in PeopleSoft along with examples of transformation rules for selected X.12 transactions. Individual trading partner specifications will vary so customizations are required for each transaction or trading partner variation.

Setup Within PeopleSoft Integration Broker

To activate a service operation, complete the following steps in PeopleSoft Integration Broker:

1. Activate the service operation.

On the General tab of the Service Operations component, select the Active check box for the applicable service operation version. If the desired version is not the default version for the service operation, the default version must also be activated.

2. For asynchronous service operations only, verify the queue is running.

On the General tab of the Service Operations component, select the View Queue link at the bottom of the page. On the Queue Definitions page, verify the Queue Status field has a value of *Run*.

3. Activate the service operation handlers.

Note: This step does not apply to all service operations.

On the Handlers tab of the Service Operations component, select the value of *Active* in the Status field for all needed handlers.

- For inbound asynchronous service operations, activate the OnNotify handler.
- For inbound synchronous service operations, activate the OnRequest handler.
- If you are using chunking on an outbound service operation, activate the OnRoute handler.

4. Activate the service operation routings.

On the Routings tab of the Service Operations component, activate a routing definition for each node that will send or receive data. To activate a routing, select the check box next to the routing definition and click the Activate Selected Routings button.

- Activate an inbound routing to receive data into PeopleSoft SCM.
- Activate an outbound routing for sending data to a third-party system or another PeopleSoft product, such as CRM.
- Activate a local routing for sending data using an effective-dated outbound service operation.
- Activate a local routing to receive inbound flat files.
- You must activate at least one routing if the data is being sent in an XML format.
- You can skip this step if a batch publish rule is set up to post to a flat file only.

5. Verify the routing definition parameters.

On the Routings tab of the Service Operations component, select the link attached to the routing definition name. This link accesses the Routing Definitions component. Select the Parameters tab and complete the following steps:

- Confirm the external alias name in the External Alias field for the routing is correct. When sending or receiving data, the Integration Broker determines which routing to use by referring to the external alias name, not the routing name.
- Add or verify the transform programs on this routing definition. A routing definition defines the sending and receiving nodes for a transaction and specifies any inbound and outbound transformations to invoke. A transform program is a type of PeopleSoft Application Engine

program that can convert data from one format to another; for example, from XML to a flat file. Use a transform program when one node sends a request or response message with a data structure different from the structure required by the other node. Many pre-defined routings are delivered with transform programs. You must decide, based on your unique situation, to change, remove, and add transform programs. For example, some delivered transform programs convert data to the EDI format, if you are not using EDI then you will want to use a different routing definition or remove that transform program from the routing definition.

6. Verify the node from the routing is active.

Go to the Node Definitions page and verify the Active Node check box has been selected for any sender or receiver nodes used in the routings that you activated on your Service Operations-Routings page.

7. For an outbound service operation, verify the node or routing is connected to the correct network.
8. For inbound service operations using a flat file, define the inbound file rule and run control parameters:
 - For X.12 formatted EDI files, use the Inbound File Loader Rules page and the Inbound File Processing run control under the Integration Broker menu.
 - For PeopleSoft formatted files, use the File Inbound page and the Inbound File run control under the Enterprise Components menu.

Setup Within PeopleSoft Enterprise Components

To activate chunking, inbound file rules, batch publish rules, or full publish rules for a service operation, complete the following steps in PeopleSoft Enterprise Components:

- Setup the publish utility.

If the outbound EIP is sending (publishing) data using the publish utility, setup full or batch data publishing.

The full publish utility automates the process of copying the contents of an entire table into another database or third-party system. You can use the utility to synchronize data between systems. The publishing rules include pages for full table publishing rules, batch publishing rules, record mapping, languages, and batch programs.

Setup for full or batch data publishing using the Full Data Publish Rules component or the Batch Publish Rules component. On both of these components, the Message Name field is the service operation. Complete the following tasks:

1. Activate the rule by selecting the value of *Active* for the Status field.
2. Specify the desired output (XML-based message or flat file).
3. If you want to use chunking select a Chunking Rule ID. The outbound data will be sent to the nodes specified by the chunking rule.

If you have more than one publish rule defined for a service operation, you should activate a rule for each batch program. For example, item status change, Item Revisions, and Item Loader each

have unique rules for the ITEM_SYNC service operation, so three rules must be activated for ITEM_SYNC.

- For outbound asynchronous service operations using chunking, activate and configure the appropriate chunk rule mapping definitions. For instance, use the BusUnit Mapping component (EO_CHUNKBU) to configure the BUSINESS_UNIT chunk rule.

See [Setting Up Chunking](#).

- Setup the inbound file rules in order to used the inbound file publish utility.

When external systems send flat files, use the inbound file publish utility to translate the incoming data into transactions that are acceptable to your PeopleSoft system. Use the Inbound File Rules page to define the file, file layout, service operation, and other parameters to accept the inbound file.

Pages Used to Set Up Service Operations

Page Name	Definition Name	Usage
Service Operations-General Page	IB_SERVICE	Define and activate a service operation.
Service Operations-Handlers Page	IB_SERVICEHDLR	Activate one or more service operation handlers.
Service Operations-Routings Page	IB_SERVICERTNGS	Define and activate routing definitions on the service operation.
Queue Definitions Page	IB_QUEUEDEFN	Activate the queue used by the service operation.
Routings-Parameters Page	IB_ROUTINGDEFNDOC	Verify the external service alias names used by this routing.
Node Definitions Page	IB_NODE	Activate node used by the service operation.
Nodes-Connectors Page	IB_NODECONN	For an outbound service operation, verify the node is connected to the correct network.
Full Data Publish Rules Page	EO_MSGPUBFULL	Activate the full data publish rule for the service operations using the full data publish rules.
Batch Publish Rules Page	EO_MSGPUBATCH	Activate the batch publish rule for the service operations using the batch publish utility.

Page Name	Definition Name	Usage
File Inbound Page	EO_FILE_INBOUND	Define the parameters to receive inbound flat files from third-party systems.

PeopleTools: Integration Broker

Related Links

[Setting Up Chunking](#)

Setting Up Chunking

If you are sending outbound data using a service operation in Integration Broker, you may want to set up chunking. When chunking, the system automatically breaks up the outbound transaction into several smaller transactions based on the values in one or more of the fields in the level zero record of the message. The message identifies the records and fields to be sent and is tied to the service operation. For example, if you want to chunk by the business unit field of the message, the outbound transaction would be broken up by business unit sending each business unit's outbound data to a node that you have defined. Another example would be for sites sending EDI transactions directly to trading partners. If you are sending purchase orders directly to a supplier, make sure that the supplier gets only their information. Chunking provides the ability to split a batch of purchase orders into separate transactions based on the trading partner. The Integration Broker then provides tools to route the transactions to specific nodes based on that trading partner identification, in this case the supplier ID.

See "PeopleSoft Electronic Data Interchange" (PeopleSoft Electronic Data Interchange).

Note: If you are using a middleware product to transform and route transactions to trading partners then you most likely will not need to use chunking. The entire outbound transaction would go to the node defined for the middleware product.

Chunking is implemented using the Batch Publish Utility or the Full Data Publish Utility. In either case a batch publish rule is created and a *chunking rule* can be attached. The chunking rule defines a table containing a set of values that map to specific nodes. For example, in the above example where you are chunking by supplier ID, the chunking rule table would contain a set of supplier IDs that map to individual nodes for trading partners receiving the purchase order data.

The following is a step by step explanation of the process flow of an outbound transaction using chunking:

1. Chunking Selection

The run process that generated the transaction. This may be the Full Data Publish Utility or one of the batch based service operations that use the Batch Publish Utility.

Note: All transactions generated from the Publish Outbound Messages process page use the Batch Publish Utility.

When the batch publish or full data publish utilities run they recognize the chunking rule assigned to the publish rule and split the data into separate XML files for each chunking rule value. The XML files are then published to the Integration Broker.

2. Chunking Node Routing

The Integration Broker makes the decision of which node will receive each XML file. Standard processing for the Integration Broker will send the outbound data to all of the nodes that have active outbound routings on the service operation. When chunking is used, the Integration Broker needs to send the outbound transaction only to the nodes specified by the chunk rule. This is done by activating the ROUTERSENDHDLR handler on the Service Operations-Handlers page. This handler is an OnRoute application class containing PeopleCode that directs the Integration Broker to only send the outbound data to the nodes that you have defined for the specific chunking rule.

PeopleSoft provides a number of chunking rules, chunking rule tables, and data entry pages that can be used to maintain node mappings and routing rules for some of the more commonly used field values. The data entry pages are noted in the Pages Used to Set up Chunking table below. Additional setup information is provided in the PeopleSoft Enterprise Components documentation explaining how to create your own customized chunking rule, chunking rule table and data entry pages.

Pages Used to Set Up Chunking

Page Name	Definition Name	Usage
Add Nodes to Chunk Rule Page	EO_ADNODECHUNK_PNL	Map nodes by Chunk Rules.
BusUnit Mapping Page	EO_CHUNKBU	Maintain ChunkRule business unit mapping.
Quick Map Page	EO_ADDBUNODE_PNL	Map business units by ChunkRules or nodes.
Map Business Unit Page	EO_ADDNODEBU_PNL	Map ChunkRules or nodes by business unit.
SetID Mapping Page	EO_CHUNKSETID	Maintain ChunkRule SetID mapping.
Quick Map Page	EO_ADDSIDNODE_PNL	Map SetIDs by ChunkRules or nodes.
Map SetIDs Page	EO_ADDNODESID_PNL	Map ChunkRules by SetID.
Customer ID Chunk Page	OM_CHUNKCUSTID	Map customer chunk rule and node to customer ID.
BU/Location Node Mapping Page	IN_CHUNKBULOCATION	Map business units chunk rule and node to location codes.

Page Name	Definition Name	Usage
BU/Par Location Node Mapping Page	IN_CHUNKBUPARLOC	Map business unit and par location chunk rule and node to par location ID.
Setup Supplier to Node Page	PO_CHUNK_VENDOR	Set up supplier chunk rule and node to supplier ID and supplier location.
PO Chunk Shipto Page	PO_CHUNK_SHIPTO	Set up ShipTo chunk rule and node to Ship To Location.
Source Code Chunk Page	OM_CHUNK_SRC_CD	Set up source code chunk rule and node to source codes.

PeopleTools: Integration Broker

See [Understanding This Troubleshooting](#)

Setting Up Electronic Data Collections

This section discusses setting up electronic data collections.

Page Used to Set Up Electronic Data Collections

Page Name	Definition Name	Usage
Data Collection Setup Page	BCT_SETUP_FS	Set up electronic data collection defaults.

Data Collection Setup Page

To enter defaults for inbound transactions, use the Bar Code Transaction Setup component.

Use the Data Collection Setup page (BCT_SETUP_FS) to set up electronic data collection defaults.

Navigation:

SCM Integrations > Setup > Define Data Collection Options > Data Collection Setup

Field or Control	Description
Transaction Number	The last transaction number used in the transaction log appears. The system uses the transaction number to automatically generate a unique number for each transaction added to the transaction log from the transaction pages. System-generated transactions also use this field.

Field or Control	Description
History Options	<p>Determines whether a history of the transactions is saved when you run the Purge process (INPYPURG) on the transactions in the transaction log.</p> <p>Options are:</p> <p><i>History for all Transactions:</i> The system maintains a history of all transactions in the transaction log.</p> <p><i>History only for Errors:</i> The system maintains a history only for transactions that have errors or warnings.</p> <p><i>No history will be maintained:</i> The system doesn't maintain a history for any transactions in the transaction log.</p>
Status of Records to Purge	<p>Determines which records the system purges when you run the Purge process.</p> <p>Options are:</p> <p><i>Complete:</i> All rows for the transaction are either canceled or successfully processed.</p> <p><i>Confirmed:</i> Purges only rows set to a confirmed status. This entry should be selected only if you have modified the interacting system to set the status of transactions to confirmed after making sure that the PeopleSoft system has processed the transaction to a complete status.</p>
File Suffix	Used as the suffix for the file name of the label extraction file, when a format ID is not specified on the label generation page.

Note: If your interacting system is selecting *Complete* transactions to mark them as being ready to purge, the BCT_STATUS on BCT_CTL should be updated from 2 (complete) to 6 (confirmed).

Related Links

[Using Electronic Data Collection Transactions](#)

[Purging Transactions](#)

[Generating Labels](#)

Setting Up BackBone InterlinX

This section provides an overview and discusses BackBone InterlinX Framework.

Pages Used to Set Up Backbone InterlinX

<i>Page Name</i>	<i>Definition Name</i>	<i>Usage</i>
<u>Define Target Set Page</u>	SAC_BBIX_TARGETSET	Set up target sets, a logical grouping of target databases for data to be synchronized with the Backbone InterlinX framework. You can enter a list of target databases or Integration Broker Nodes for data to be "pushed" to or "pulled" from in order to define your target sets.
<u>Integration Definition Page</u>	SAC_BBIX_DEFN	Set up integrations, a record or group of records that you wish to synchronize with other PeopleSoft databases within the BackBone InterlinX Framework. You can select the data options for integrating with your target databases.
BBIX User Exit Processing Page	SAC_BBIX_USER_EXIT	Set up additional processing to be done before and/or after data is synchronized using the BackBone InterlinX Framework.

Understanding BackBone InterlinX

BackBone InterlinX provide a metadata-driven, generic framework for data synchronization of tables between PeopleSoft databases. This framework enables PeopleSoft data synchronization through a single, metadata-driven EIP, thereby leaving standard EIPs to do their intended purpose of providing integration "services".

The design concepts behind the BackBone InterlinX Framework provide:

- A single, generic, metadata-driven EIP for selecting and/or synchronizing data between PeopleSoft databases of varied releases.
- A private EIP that does not expose any additional unnecessary EIP contracts to the outside world.
- An internal EIP that is not intended for external use and not posted to the ISR for external-use or support.
- The ability to synchronize record level data independent of application business logic.
- The ability to leverage XSL transformations for data model changes between releases.

BackBone InterlinX provides a simple, metadata-driven, Integration Broker-based solution for data synchronization. In addition, BackBone InterlinX provides data query ("Data Pull") capabilities using XML that are not offered with ETL tools.

Prerequisites

The following objects must be activated and configured correctly within the PeopleSoft Integration Broker for the Backbone InterlinX Framework to work:

- Service operation SAC_BBIX_MESSAGE.
- Message SAC_BBIX_MESSAGE.
- Queue SAC_BBIX.
- Service operation routings.
- Service operation handler INBOUND_SAC_BBIX

Define Target Set Page

Use the Define Target Set page (SAC_BBIX_TARGETSET) to set up target sets, a logical grouping of target databases for data to be synchronized with the Backbone InterlinX framework.

You can enter a list of target databases or Integration Broker Nodes for data to be "pushed" to or "pulled" from in order to define your target sets.

Navigation:

SCM Integrations > Backbone InterlinX > Define Target Set

<i>Field or Control</i>	<i>Description</i>
Target Set	Enter an identifier for your target set.
Node Name	Enter a PeopleSoft Integration Broker Node with which to synchronize data. Note: Add additional rows for each Node that you wish to integrate with for this target set ID.

PeopleTools: Integration Broker

Integration Definition Page

Use the Integration Definition page (SAC_BBIX_DEFN) to set up integrations, a record or group of records that you wish to synchronize with other PeopleSoft databases within the Backbone InterlinX Framework.

You can select the data options for integrating with your target databases.

Navigation:

SCM Integrations > Backbone InterlinX > Define Integration

This example illustrates the fields and controls on the Integration Definition. You can find definitions for the fields and controls later on this page.

BackBone InterlinX

Integration Definition

This is the BackBone InterlinX meta-data definition for the "pushing" and "pulling" of data from one PeopleSoft database to another.

Definition

Integration ID: CUSTOMER Active:

*Description:

*Processing: Standard Mode *Data: Setup Data

*Action: Data Push Segment Size (rows):

Processing Options Find | View All | First 1 of 1 Last

*Import Option: Update and Append only + -

Record:

*Fields: All Fields

Filter:
e.g.: WHERE SETID = 'SHARE'

Target Node(s) Personalize | Find | View All | First 1 of 1 Last

#	*Target Set ID	Description	Map Set ID
1	<input type="text" value=""/>		<input type="text" value=""/>

Field or Control	Description
Integration ID	Enter an ID for your integration.
Active	Click to indicate that the integration is active. If cleared, the integration is inactive. Inactive integrations will not publish data.
Processing	<p>Determines how the integration will be processed. Options include:</p> <p><i>Standard Mode:</i> Select to enables the Processing Options group box so that you can execute the integration either from the BBIX Run Control Component or directly from PeopleCode.</p> <p><i>PeopleCode Only Mode:</i> Select to disables the Processing Options group box so that you can only execute the integration using PeopleCode.</p>

Field or Control	Description
Data	<p>Determines the type of data that the integration will synchronize. Options include:</p> <p><i>Setup Data:</i> Data is synchronized and committed record by record</p> <p><i>Transaction Data:</i> Data is synchronized and committed based on a parent-child transaction model. When this option is selected, the first record in the Processing Options group box is used as the parent record, and all additional records are used as child records.</p> <p>The system synchronizes data one parent row and all of the corresponding children rows at a time. Each parent row and the children rows is considered a logical transaction.</p> <p>This option is only available with the processing option of <i>Standard Mode</i>.</p>
Action	<p>Select to determine whether data is sent to or retrieved from the target sets. Options include:</p> <p>Data Push – Data is sent to the defined target set(s).</p> <p>Data Pull – Data is retrieved from the defined target set(s).</p> <p>This option is only available with the processing option of <i>Standard Mode</i>.</p>

Processing Options

Field or Control	Description
Import Option	<p>Select to determine whether data is deleted from tables before synchronization occurs. Options include:</p> <p><i>Update and Append Only:</i> Data is not deleted from the source or target database(s). The data sent is updated if the record already exists or added if the record does not exist in the target for a "Data Push" or in the source for a "Data Pull".</p> <p><i>Delete All Record Data:</i> The system deletes data from the source or target database. ALL of the data in the table is deleted in the target for a "Data Push" or in the source for a "Data Pull" before the new data is inserted.</p> <p><i>Delete Records using Filter:</i> Data is deleted from the source or target database(s) based on the record "filter" that is defined. The data that matches the "filter" condition in the table is deleted in the target for a "Data Push" or in the source for a "Data Pull" before the new data is inserted.</p> <p>This option is only available with the processing option of <i>Standard Mode</i> and Setup Data.</p>
Record	<p>Select a table to synchronize.</p> <hr/> <p>Note: For transaction data, the key values on the parent record must exist in all child records.</p> <hr/> <p>This option is only available with the processing option of <i>Standard Mode</i>.</p>
Fields	<p>Select to determine whether to synchronize all fields on the record or a list of fields. Options include:</p> <p><i>All Fields:</i> All fields on the record are synchronized.</p> <p><i>List of Fields:</i> Enables a subset of the fields on the record to be synchronized. When selected, you can create rows and search for each field on the selected record. However, the key fields for a record are always synchronized.</p> <hr/> <p>Note: If fields are sent in a "Data Push" that do not exist in the target database(s), then these extra fields are ignored. However, if specific fields are selected within a "Data Pull" that do not exist in the target database(s), then data will not be synchronized.</p> <hr/>

Field or Control	Description
Filter	Create a filter or WHERE clause to subset the data to be synchronized. If not entered, then the entire record is used. This field is not required.

Target Nodes

Field or Control	Description
Target SetID	Determines the Target Set with which to synchronize the integration. If you don't select at least one Target Set, then the integration will be sent based on the Integration Broker service operation defined for the SAC_BBIX_MESSAGE message.
Map SetID	Enter the map SetID for which you want to map the integration.

Implementing XML Mapper

This section provides an overview of XML Mapper and discusses how to set it up.

Pages Used to Set Up XML Mapper

Page Name	Definition Name	Usage
Defining Maps Page	SAC_MAP_DEFN	Use to define the type of transformation and to which message, records, and fields it applies.
Map Detail Page	SAC_MAP_DEFN_DTL	Use to specify the map type detail.
Define Map Sets Page	SAC_MAPSETDEFN	Use to group maps together, order them, and specify in which directions they apply.
Define Node Associations Page	SAC_NODE_ASSOC	Use to associate a source node and a target node with a map set. All maps in an associated map set will then execute using the node association. Before defining a node association, set up an Integration Broker service operation routings for your nodes.

Understanding XML Mapper

XML Mapper enables you to map values between your database and an external trading partner database. For example, if you are integrating to a computer hardware supplier, if you use a field called business unit, and the supplier uses a field called BU, you can set up a mapping relationship where your outbound purchase order XML transaction automatically converts data in business unit fields to BU fields.

Prerequisites to Using XML Mapper

Before you begin using XML Mapper, you must:

- Activate service operations set up in Integration Broker.
- Set up an integration broker relationship including transaction modifiers for the node associations.

PeopleTools: Integration Broker

Defining Maps Page

Use the Define Map page (SAC_MAP_DEFN) to use to define the type of transformation and to which message, records, and fields it applies.

Navigation:

SCM Integrations > XML Mapper > Define Maps

This example illustrates the fields and controls on the Define Maps. You can find definitions for the fields and controls later on this page.

The screenshot shows the 'Define Map' page in PeopleTools. At the top, there are two tabs: 'Define Map' (selected) and 'Map Detail'. Below the tabs, the 'Map ID' is 'OSN_INBOUND_INV_UOM' and there is a checked 'Active' checkbox. The '*Description' field contains 'Unit Of Measure'. The '*Map Type' dropdown is set to 'Field Value'. Under 'Map Level', 'All Messages' is selected. The 'Message' field is empty. The 'Map Match Criteria' section has a '*Criteria' dropdown set to 'Record/Field'. Under this, 'All Records' is selected. The 'Record' and 'Field' fields are empty, with a magnifying glass icon next to the 'Field' field.

Field or Control	Description
Map Type	<p>Select to specify a map type for this map. The value you select determines the options available on the Map Detail page. Options include:</p> <p><i>Application Class:</i> maps data using an application class that you specify. Selecting this makes the application class ID and application class path fields available on the Map Detail page. Specify an extension of class <code>SCM_SAC_XMLMAPPER:Maps:MapBase</code>, and be certain the specified class implements method <code>TransformXMLString()</code>.</p> <p><i>Attribute Value:</i> maps the values associated with a specific XML attribute. Selecting this makes the internal value and external value fields available on the Map Detail page.</p> <p><i>Field Alias:</i> enables the renaming of fields, such as renaming a field called <i>business unit</i> to <i>BU</i>. Selecting this makes the internal field name and external field name fields available on the Map Detail page.</p> <p><i>Field Value:</i> enables the revaluing of fields. For example, externally, a business unit could be called <i>NY Operations</i>, internally, it could be called <i>US007</i>. Selecting this makes the internal value and external value fields available on the Map Detail page.</p> <p><i>Field Value — SQL:</i> maps field values using a SQL object. The SQL objects should return two values: internal value and external value, in that order. Selecting this makes the SQL object identifier field available on the Map Detail page.</p> <p><i>Record Alias:</i> enables the renaming of records. Selecting this makes the internal record and external record fields available on the Map Detail page.</p> <p><i>Values Only:</i> sets up a simple list of mapped values that you can use from code. Selecting this makes the internal value and external value fields available on the Map Detail page.</p> <hr/> <p>Note: This map type is never run automatically.</p> <hr/> <p><i>XSL:</i> maps data using XSL that you provide. Selecting this makes the XSL field available on the Map Detail page.</p> <p>See Map Detail Page.</p>
Map Level	<p>Select All Messages to apply this map to all active messages, or Specific Message to apply this map to one message only.</p> <p>This option is only available if you select a map type of application class, attribute value, field alias, field value, record alias, or XSL.</p>
Message	<p>Enter the specific message to map to if you selected the specific message mapping level.</p>

Map Match Criteria

<i>Field or Control</i>	<i>Description</i>
Attribute Name	Enter a name for the attribute. The system displays this field only when you have selected an attribute value map type.
Criteria	<p>Enter criteria used to map the data. This is only available if you have selected a field alias, field value, field value — SQL map type. Options include:</p> <p><i>None</i>: no criteria will be used to map the data other than that found on the Map Detail page.</p> <hr/> <p>Note: This value is for system use only. You must select a value other than <i>None</i>.</p> <hr/> <p><i>Record/Field</i>: to map data by a specified record or field. You can choose All Records, Specific Record, and select a Record, or select a <i>Field</i>.</p> <p><i>XPath</i>: select to enter an XPath expression that will specify everything BUT the values you would like to map. Additional XPath text will be appended to your XPath based on the values specified on the Map Details page.</p> <p>For example, if A and B are specified as Internal and External values, respectively, the XPath expression //RECORD_NAME/FIELDNAME would become //RECORD_NAME/FIELDNAME/text()[.='A'] for an outbound transaction.</p> <p>If you select this option, enter a <i>Pattern</i>.</p>

Map Detail Page

Use the Map Detail page (SAC_MAP_DEFN_DTL) to use to specify the map type detail.

Navigation:

SCM Integrations > XML Mapper > Define Maps > Map Detail

<i>Field or Control</i>	<i>Description</i>
Application Class Path	Specify an extension of class SCM_SAC_XMLMAPPER:Maps:MapBase. Be certain the specified class implements method TransformXMLString(). The system displays this field only when you have selected an application class map type on the Define Map page.

Field or Control	Description
Application Class ID	Select a valid application class ID that is available at the specified application class path. The system displays this field only when you have selected an application class map type on the Define Map page.
Internal Value	Enter the value you wish to convert to on an inbound transaction or convert from on an outbound transaction. The system displays this field only when you have selected an attribute value, field value, or values only map type on the Define Map page.
External Value	Enter the value you wish to convert from on an inbound transaction or convert to on an outbound transaction. The system displays this field only when you have selected an attribute value, field value, or values only map type on the Define Map page.
Internal Field Name	Enter the value you wish to convert to an inbound field name or from an outbound field name. The system displays this field only when you have selected a field alias map type on the Define Map page.
External Field Name	Enter the value you wish to convert from an inbound field name or to an outbound field name. The system displays this field only when you have selected a field alias map type on the Define Map page.
SQL Object Identifier	Select a SQL Object Identifier. The system displays this field only when you have selected a field value — SQL map type on the Define Map page.
Internal Record Name	Enter the value you wish to convert to on an inbound record or convert from on an outbound record. The system displays this field only when you have selected a record alias map type on the Define Map page.
External Record Name	Enter the value you wish to convert from an inbound record name or to an outbound record name. The system displays this field only when you have selected a record alias map type on the Define Map page.
XSL	Enter your own custom XSL transformation. The system displays this field only when you have selected a map type of XSL on the Define Map page.

Define Map Sets Page

Use the Define Map Sets page (SAC_MAPSETDEFN) to use to group maps together, order them, and specify in which directions they apply.

Navigation:

SCM Integrations > XML Mapper > Define Map Sets

This example illustrates the fields and controls on the Define Map Sets page. You can find definitions for the fields and controls later on this page.

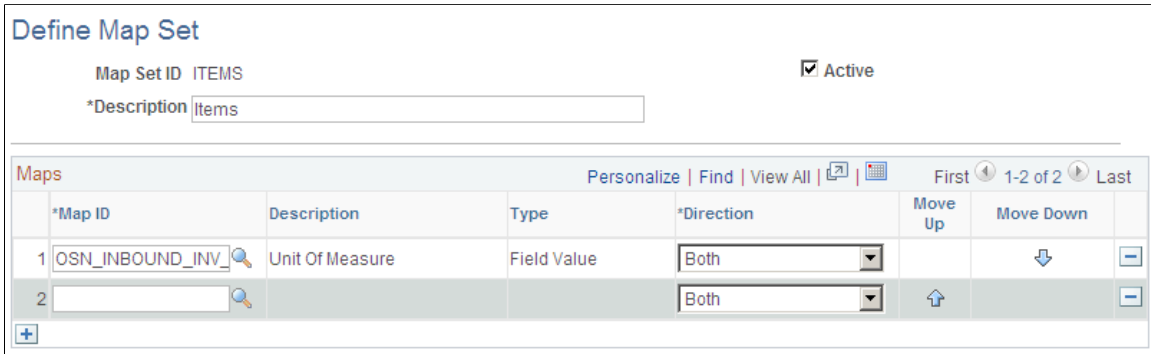

Field or Control	Description
Map SetID	Create a map set ID to designate each map set.
Active	This option must be selected for the XML mapper to complete data transformations.
Map ID	Select a Map ID to associate with this map set. You can associate multiple map IDs with a single map set.
Direction	Enter the direction for which the selected map should apply. Options include <i>Inbound</i> for inbound transactions, <i>Outbound</i> for outbound transactions, or <i>Both</i> if you want the map set to be used for inbound and outbound transactions.
Arrows	Choose the order in which the maps should be run.

Define Node Associations Page

Use the Define Node Associations page (SAC_NODE_ASSOC) to use to associate a source node and a target node with a map set.

All maps in an associated map set will then execute using the node association. Before defining a node association, set up an Integration Broker service operation routings for your nodes.

Navigation:



SCM Integrations > XML Mapper > Define Node Associations

This example illustrates the fields and controls on the Define Node Associations page. You can find definitions for the fields and controls later on this page.

Define Node Associations

Source Node PSFT_ORACLE_SUPPLIER_NETWORK Oracle Supplier Network

Target Node PSFT_ORACLE_SUPPLIER_NETWORK Oracle Supplier Network

Map Sets Personalize | Find |   First ◀ 1 of 1 ▶ Last

	*Map Set ID	Description
1	<input type="text" value=""/>	

+ -

Field or Control	Description
Map SetID	Enter a map set ID to use with the source node and target node.
Arrows	Choose the order in which the map sets should be run.

Chapter 4

Processing Enterprise Integration Points (EIPs)

Processing Inbound EIPs

This section discusses how to use transaction maintenance, use data definition maintenance, and purge transactions.

Pages Used to Process Inbound EIPs

<i>Page Name</i>	<i>Definition Name</i>	<i>Usage</i>
<u>Transaction Maintenance Page</u>	BCT_CTL_UPD	View all electronic transactions in the transaction log and access the detail pages that enable you to correct transaction errors.
<u>Data Def Maint Page</u>	EO_EIP_CTL_MAINT	View data detail or correct errors for inbound EIPs that contain data rather than transactions.
<u>Purging Page</u>	BCT_INV_REQPURG	Initiate the Purge Application Engine process (IN_BCT_PURGE) that purges transactions for EIPs.

Transaction Maintenance Page

Use the Transaction Maintenance page (BCT_CTL_UPD) to view all electronic transactions in the transaction log and access the detail pages that enable you to correct transaction errors.

Navigation:

SCM Integrations > Transaction Error Handling > Maintain Transactions > Transaction Maintenance

This example illustrates the fields and controls on the Transaction Maintenance page. You can find definitions for the fields and controls later on this page.

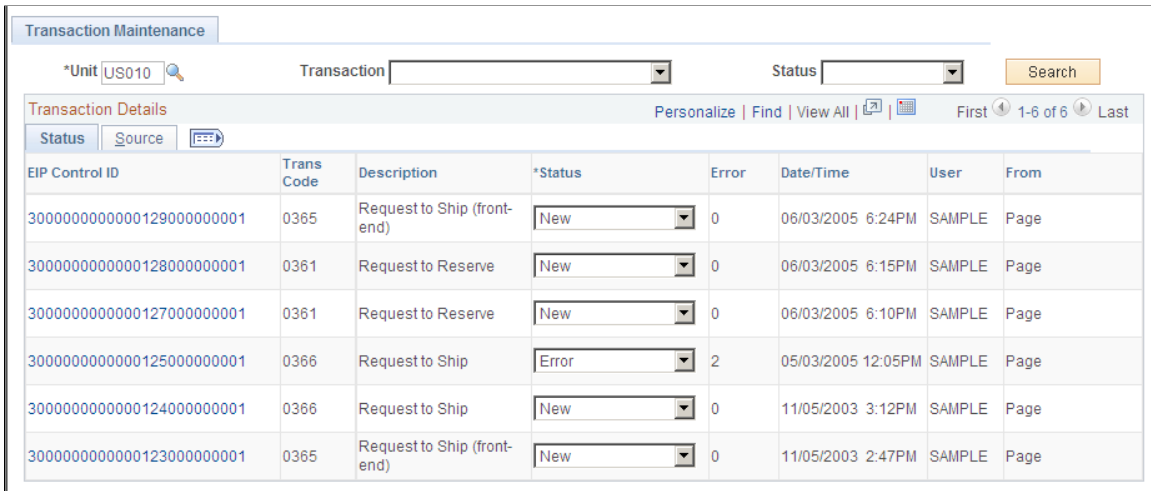

All transactional-based information appears on this page. The system displays the transaction code, which identifies the transaction type, and the transaction description.

Field or Control	Description
EIP Control ID	Click this link to view the transaction line details for the transaction. Detail pages for each transaction type, which are accessible from this page, provide error messages and transaction details that enable you to revise fields containing errors.

You can modify the transaction status here or in the Transaction Maintenance Detail pages. The rules for changing a transaction status are:

Current Status	Change to Status
New	Complete (cancels all lines in the transaction).
Error	Complete (cancels all lines in the transaction). Reprocess.
Complete	Can't be changed.
In Process	Can't be changed.
Reprocess	Complete (cancels all lines in the transaction).
Incomplete	Can't be changed.

Data Def Maint Page

Use the Data Def Maint page (EO_EIP_CTL_MAINT) to view data detail or correct errors for inbound EIPs that contain data rather than transactions.

Navigation:

SCM Integrations > Transaction Error Handling > Maintain Data Definitions > Data Def Maint

This example illustrates the fields and controls on the Data Def Maint (page). You can find definitions for the fields and controls later on this page.

The screenshot shows the 'Data Def Maint' page with the following search filters:

- Transaction Type:
- Grid Select:
- SetID:
- Unit:
- Reference:
- Status:

A 'Search' button is located below the filters.

The 'Stage Table Data' table is displayed with the following columns: Stage Data, Reference, Publish Data, Date Time, Process Instance, Status, EIP Control ID, Transaction Type, Description, and User.

Stage Data	Reference	Publish Data	Date Time	Process Instance	Status	EIP Control ID	Transaction Type	Description	User
<input type="checkbox"/>	1		New			4000000000014130000000001	ITEM	Item Loader & ITEM_SYNC	SAMPLE
<input type="checkbox"/>	2		Complete			3000000000005167000000001	PO	Inbound Sales Order - 850	SAMPLE
<input type="checkbox"/>	3		Complete			3000000000000126000000001	PO	Inbound Sales Order - 850	SAMPLE
<input type="checkbox"/>	4		Error			1653645435956907000000001	PO	Inbound Sales Order - 850	VP1
<input type="checkbox"/>	5		Error			4000000000000183000000001	ITEM	Item Loader & ITEM_SYNC	
<input type="checkbox"/>	6		Error			1461531418805505000000002	PRODUCTMST	Product Master	
<input type="checkbox"/>	7		Error			1461531418805505000000011	PRODUCTMST	Product Master	
<input type="checkbox"/>	8		Error			1461531418805505000000001	PRODUCTMST	Product Master	
<input type="checkbox"/>	9		Error			1461531418805505000000007	PRODUCTMST	Product Master	
<input type="checkbox"/>	10		Error			1461531418805505000000003	PRODUCTMST	Product Master	

All data definition transactions appear on this page. Detail pages for each transaction type, which are accessible from this page, provide error messages and transaction details that allow you to revise fields containing errors.

If you want to retrieve records by transaction, select one of these transaction types:

Transaction Type	Description
AP - 100	Retrieves supplier synchronization transactions that have been received. To receive supplier synchronization transactions, you must have PeopleSoft Payables installed.
AP - 200	Retrieves supplier edit transactions that have been received. To receive voucher edit transactions, you must have PeopleSoft Payables installed.

Transaction Type	Description
ASNIN	Retrieves advanced shipping receipt transactions that have been received. To receive Advanced Shipping Receipt transactions, you must have PeopleSoft Purchasing installed.
BOM	Retrieves bills of material transactions that have been received. To receive bills of material transactions, you must have PeopleSoft Manufacturing installed.
CONSUMER	Retrieves consumer sync transactions that have been received. To receive consumer sync transactions, you must have PeopleSoft Inventory installed.
ITEM	Retrieves item loader and item sync transactions that have been received. To receive item loader and item sync transactions, you must have PeopleSoft Inventory, PeopleSoft eProcurement, or PeopleSoft Purchasing installed.
ITM_MFGGPO	Retrieves manufacturer group purchasing organization (GPO) item price list transactions that have been received. To receive manufacturer GPO item price list transactions, you must have PeopleSoft Purchasing or PeopleSoft Inventory installed.
PO	Retrieves purchase order transactions that have been received. To receive inbound sales order (850) transactions, you must have PeopleSoft Order Management installed.
POACK	Retrieves purchase order acknowledgement transactions that have been received. To receive purchase order acknowledgement transactions, you must have PeopleSoft Purchasing installed.
POCHG	Retrieves purchase order change transactions that have been received. To receive sales order change (860) transactions, you must have PeopleSoft Order Management installed.
PROCARD	Retrieves procurement card transactions that have been received. To receive procurement card transactions, you must have PeopleSoft Purchasing or PeopleSoft eProcurement installed.
PRODUCTMST	Retrieves product master transactions that have been received. To receive product master transactions, you must have PeopleSoft Order Management installed.
REQLOAD	Retrieves requisition loader transactions that have been received. To receive requisition loader transactions, you must have PeopleSoft Purchasing or PeopleSoft eProcurement installed.

Transaction Type	Description
RFQ	Retrieves request for quotation (RFQ) transactions that have been received. To receive inbound request for quote (840) transactions, you must have PeopleSoft Order Management and PeopleSoft Purchasing installed.
RFQRESP	Retrieves RFQ response transactions that have been received. To receive RFQ response transactions, you must have PeopleSoft Purchasing installed.
RMALOAD	Retrieves inventory RMA transactions that have been received. To receive RMA load transactions, you must have PeopleSoft Inventory installed.

Field or Control	Description
Grid Select	Some transactions are loaded into staging tables while others remain in the Integration Broker queue until they are successfully processed. Select <i>Queue</i> to view those residing in the Integration Broker queue and <i>Staged</i> to view those that are in a stage table.
Search	Click this button to display all the transactions that match the search criteria selected. Note: To display all of the records in the transaction log, leave the search criteria fields blank.
	Click the Show Detail Entry button to access the detail pages. Detail pages for each transaction type, which are accessible from this page, provide error messages and transaction details that enable you to revise fields containing errors.

Related Links

"PeopleSoft Electronic Data Interchange" (PeopleSoft Electronic Data Interchange)

Purging Page

Use the Purge page (BCT_INV_REQPURG) to initiate the Purge Application Engine process (IN_BCT_PURGE) that purges transactions for EIPs.

Navigation:

SCM Integrations > Process Transactions > Purge > Transactional Data > Purge

Use this page to initiate the Purge process. The Purge process will delete all transactions with a status of *Complete* or *Confirmed* from the transaction log.

Use the Data Collection Setup page to choose to not maintain a history, to maintain a history for all transactions, or to maintain a history only for transactions containing errors. You can also determine whether to purge transactions with a status of *Complete* or *Confirmed* on this page.

You can view the transaction history by running a query. Use the BCT_HIST and BCT_ERR_HIST tables to view the transaction history.

Inbound Data to Purge

You can choose to purge all transactions, whereby the system purges all transactions containing either the *Confirmed* or *Complete* status that you set up on the Data Collection Setup page. Or you can enter a number of days to purge only items with at least that many days since the last activity.

Processing Outbound EIPs

This section discusses how to process outbound EIPs.

Page Used to Process Outbound EIPs

<i>Page Name</i>	<i>Definition Name</i>	<i>Usage</i>
<u>Publish Outbound Message Page</u>	IN_RUN_PUB_MSG	Initiate the outbound message publish process for outbound PeopleSoft SCM transactions that use the batch publish design pattern.

Publish Outbound Message Page

Use the Publish Outbound Message page (IN_RUN_PUB_MSG) to initiate the outbound message publish process for outbound PeopleSoft SCM transactions that use the batch publish design pattern.

Navigation:

SCM Integrations > Publish Outbound Message

This example illustrates the fields and controls on the Publish Outbound Message page. You can find definitions for the fields and controls later on this page.

Note: This page is used only to process transactions that use the batch publish design pattern.

Select the check box by the name of the message (service operation) that you want to process. The system then makes the message name a link to a transaction-specific page for that service operation. You can process service operations one at a time or in multiples.

Processing Backbone Interlinks

This section discusses how to run the Backbone Interlink process.

Page Used to Process Backbone Interlinks

<i>Page Name</i>	<i>Definition Name</i>	<i>Usage</i>
BankBone InterlinX - Process Request Page	SAC_BBIX_RUN_CNTL	Initiates transferring data from one PeopleSoft database to another.

BankBone InterlinX - Process Request Page

Use the BankBone InterlinX - Process Request page (SAC_BBIX_RUN_CNTL) to initiates transferring data from one PeopleSoft database to another.

Navigation:

SCM Integrations > BackBone InterlinX > Run BBIX Process > BankBone InterlinX - Process Request

<i>Field or Control</i>	<i>Description</i>
Override	Select this check box to override the integration's default filter with a custom filter to use when processing the integration. Once selected, the system makes the Filter field available for entry.

Understanding Warehouse Management Systems

General WMS Integration Issues

This section discusses system-wide assumptions about WMS integration.

Integrating PeopleSoft with a third-party WMS enables you to streamline the order-to-cash and procure-to-pay business processes. This streamlining enables you to reduce costs, improve service levels, and generate more revenue.

You can integrate the following products with a WMS:

- PeopleSoft Purchasing.
- PeopleSoft Payables.
- PeopleSoft Order Management.
- PeopleSoft Inventory.

The integration consists of generic EIPs using service operations in PeopleSoft Integration Broker to exchange transactional and static data between the PeopleSoft system and the WMS. Transactional data relates to order processing and material management. Static data relates to customers, items, carriers, and locations.

System-Wide Assumptions About WMS Integration

The WMS integration works as designed only if you understand certain system-wide assumptions and your system complies with them. The following sections discuss these assumptions.

Business Units

One WMS installation corresponds to one PeopleSoft Inventory business unit. When defining the PeopleSoft Inventory business unit in the PeopleSoft system, you specify that the business unit is under external warehouse control on the Inventory Definition - Business Unit Options page.

Static Information

All static information, such as customer, supplier, carrier, and item information, is maintained in the PeopleSoft system. Updates are sent to the WMS when new information is added or changes are made to existing information. Changes made to this information within the WMS are not sent back to the PeopleSoft system.

Quantity Balance Data

The WMS drives all inventory balances. The WMS sends material movement transactions to the PeopleSoft system. Any material movement transactions initiated in the system are *not* sent to the WMS. If the WMS is not manually updated to reflect a material movement transaction performed in the PeopleSoft system, quantity balance data between the two systems will not agree.

Open and Hold Stock Status Attributes

The PeopleSoft system does not need to track on-hand quantity balances at the material storage location level because all material movement transactions occur within the WMS. In most cases, quantity balances in the PeopleSoft system can be maintained at the business-unit level by using the *Open* or *Hold* stock status attributes to determine which stock is available to fulfill orders. In this balance structure, you can use the PeopleSoft material storage location balance record, `PHYSICAL_INV`, to maintain the *Open* and *Hold* quantity balances. Two storage location balance records are created in `PHYSICAL_INV`: one for stock quantity with an *Open* status and another for stock quantity with a *Hold* status.

When determining whether to use this structure or a more detailed balance structure, take the following considerations into account:

- Material storage locations can have a status of only *Open* or *Hold*.

Inventory status values of *Restricted* and *Rejected* are not used in a WMS integration. You should always initiate status updates in the WMS. Status changes made using the Inventory Status page or the Lot Control Information page in PeopleSoft Inventory are not reflected in the WMS and may cause discrepancies between the available (that is, *Open*) and unavailable (or *Hold*) quantity balances in the two systems.

- The status update data that the WMS sends to the PeopleSoft system does not directly change the status of stock.

Instead, the WMS reports a material storage location stock transfer in which the stock is moved to a location with the appropriate status, *Open* or *Hold*. The Inventory Transfer EIP (the EIP used to send status update data to PeopleSoft) is designed with the assumption that the *Open* or *Hold* status of a material storage location is handled in the WMS mapping logic to support the status update transaction. If the WMS implementation uses the material storage location fields in PeopleSoft Inventory for purposes other than tracking *Open* and *Hold* balances, these fields must be accounted for in the mapping logic.

- All key fields related to item definition in the PeopleSoft Inventory material storage location balance table, `PHYSICAL_INV`, are supported for transactions that allow entry of the item ID.

These fields include the business unit, item, staged date, lot ID, serial ID, container ID, and unit of measure. If you want to maintain a breakdown of balances at a lower level than the item ID (for example, at the lot ID or serial ID level), all transactions entered against these balances must contain all item definition keys.

- Modifications to the check boxes on the Material Storage Locations page in PeopleSoft Inventory can affect available balances for items in that location.

Changes made to these settings are not reflected in the WMS and may cause discrepancies in the available and unavailable quantity balances between the two systems.

Related Links

"Understanding Inventory Status" (PeopleSoft Inventory)

WMS EIPs

The EIPs used to exchange data between the PeopleSoft system and a WMS are service operations defined within PeopleSoft Integration Broker.

The following diagram illustrates the data flow between the WMS and PeopleSoft Inventory, Order Management, Purchasing, and Payables:

The following diagram illustrates the data flow.

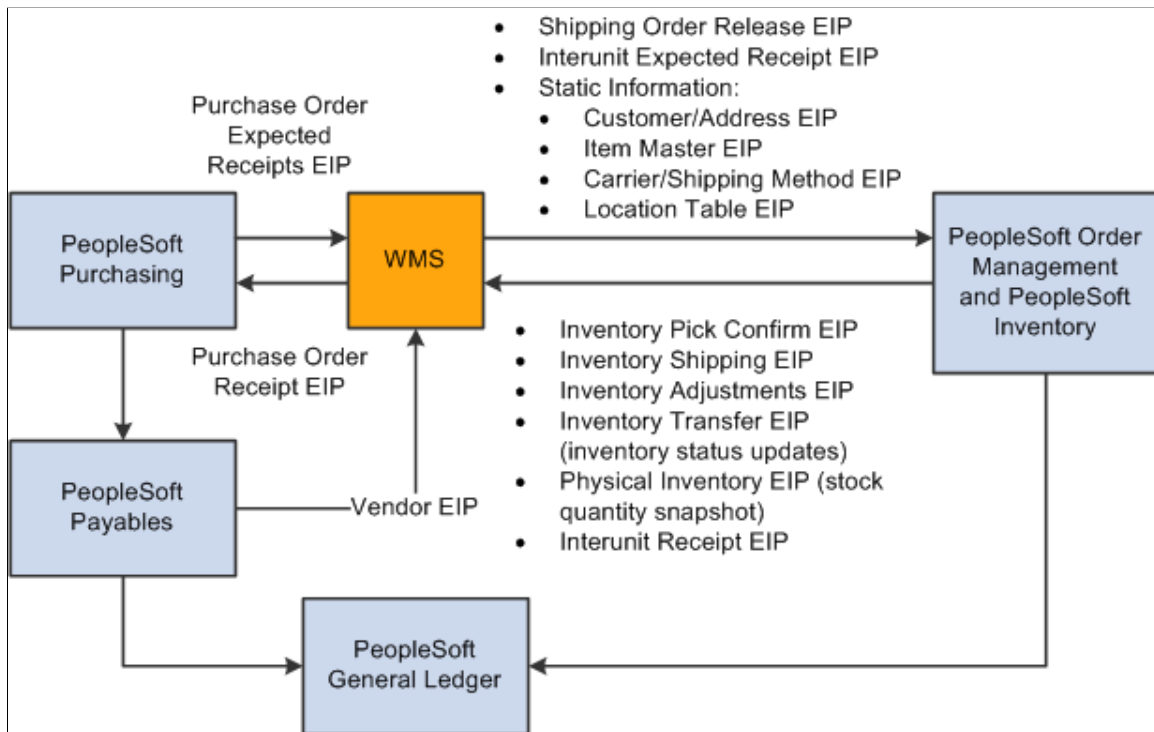

The following sections describe the information that each EIP provides.

PeopleSoft Purchasing

The EIPs within PeopleSoft Purchasing are:

<i>EIP Name</i>	<i>Description</i>
Purchase Order Expected Receipt EIPs (outbound)	Provides the WMS with a list of expected receipts that have not been received for a dispatched purchase order. This integration point includes the following service operations; PO_EXPECTED_RECEIPT_SHIPTO and the PO_EXPECTED_RECEIPT_BUS_UNIT.

<i>EIP Name</i>	<i>Description</i>
Purchase Order Receipt EIP (inbound)	This service operation updates the status of purchase order receipts in the PeopleSoft system to indicate whether the quantity on the receipt has been received in the WMS system.

PeopleSoft Order Management and PeopleSoft Inventory

The EIPs within PeopleSoft Order Management and PeopleSoft Inventory are:

<i>EIP Name</i>	<i>Description</i>
Shipping Order Release EIP (outbound)	This service operation provides the WMS with details of orders that have been released for picking and shipment.
Interunit Expected Receipt EIP (outbound)	This service operation notifies the WMS that an interunit stock transfer has been shipped to it from another PeopleSoft Inventory business unit.
Customer/Address EIPs (outbound)	Updates the customer and address information in the WMS with the current information in the PeopleSoft system. There are several service operations in this category, starting with CUSTOMER.
Item Master EIPs (outbound)	Updates item master, item business unit attributes, purchasing item attributes, item unit of measure, and item revision information in the WMS with the current information in the PeopleSoft system. There are several service operations in this category, starting with ITEM.
Carrier/Shipping Method EIPs (outbound)	Updates carrier and shipping method information in the WMS with the current information in the PeopleSoft system. There are several service operations in this category, starting with CARRIER.
Location Table EIPs (outbound)	Updates internal ship to location data in the WMS with the current information in the PeopleSoft system. There are several service operations in this category, starting with LOCATION.
Inventory Pick Confirm EIP (inbound)	This service operation reports picking and shipping activities to the PeopleSoft system.

<i>EIP Name</i>	<i>Description</i>
Inventory Shipping EIP (inbound)	This service operation reports picking and shipping activities to the PeopleSoft system.
Inventory Adjustment EIP (inbound)	This service operation reports adjustments in stock quantity balances to PeopleSoft.
Inventory Transfer EIP (inbound)	This service operation reports transfers of stock quantity between material storage locations. In a WMS integration, this data is used by the WMS to modify the inventory status in PeopleSoft Inventory to <i>Open</i> or <i>Hold</i> . The stock quantity is logically transferred to a location with the appropriate status.
Physical Inventory EIP (inbound)	This service operation reports cycle counting and complete physical inventory activities. In a WMS integration, this data is used to synchronize the quantity balances between the two systems. PeopleSoft Inventory processes this data as a stock quantity update from a counting event.
Interunit Receipt EIP (inbound)	This service operation updates the status of interunit receipts in PeopleSoft to indicate whether the quantity on the receipt has been received in the WMS system.

Note: If the Inventory business unit is integrated with WMS and uses the return to vendor (RTV) feature in PeopleSoft Purchasing, then you cannot use the *Express* option for the RTV Inventory Ship Option or the RTV Inventory Destroy Option in PeopleSoft Purchasing. The express option could cause the stock quantities between the PeopleSoft Inventory business unit and the WMS to become out of balance.

Note: In prior releases of PeopleSoft Inventory, the Shipping Notification EIP was used to send back picking and shipping details from the WMS system. The Shipping Notification EIP is available for backwards compatibility to earlier releases. However, if you are currently implementing the integration point between PeopleSoft Inventory and a WMS, use the Inventory Pick Confirm EIP and the Inventory Shipping EIP instead of the Shipping Notification EIP.

PeopleSoft Payables

The EIPs within PeopleSoft Payables are:

<i>EIP Name</i>	<i>Description</i>
Supplier EIPs (outbound)	Updates the WMS with the current data from the supplier table and its related tables in the PeopleSoft system. There are several service operations in this category, starting with Supplier.

PeopleSoft General Ledger

PeopleSoft General Ledger is not directly integrated with the WMS. Instead, it is updated by transactions in PeopleSoft Payables, PeopleSoft Order Management, and PeopleSoft Inventory.

Related Links

[PeopleSoft SCM Inbound EIPs](#)

[The Order-to-Cash Business Process in a WMS Integration](#)

[The Procure-to-Pay Business Process in a WMS Integration](#)

[Four-Wall Warehousing Functions in a WMS Integration](#)

[Static Information Updates in a WMS Integration](#)

"Understanding Inventory Status" (PeopleSoft Inventory)

"Understanding Counts" (PeopleSoft Inventory)

The Order-to-Cash Business Process in a WMS Integration

This section discusses:

- Order entry.
- Reservation processing.
- Order release processing.
- Order changes.
- Shipping processing.

The order-to-cash business process enables companies to sell their goods and services to customers. Here is an overview of the process in a WMS integration:

1. PeopleSoft components are used to take the customer orders, reserve the orders against available quantity balances, and release the orders to the WMS.
2. In the WMS, the orders are picked, packed, and shipped to the customer.
3. PeopleSoft provides shipment tracking, advanced shipment notice transactions, costing, accounting, invoicing, and cash collection functions.

Order-to-Cash Process Flow in a WMS Integration

The following diagram illustrates the order-to-cash flow between PeopleSoft and a WMS. The PeopleSoft system is the entry point for the order where the stock is then reserved and released to the WMS using the Shipping Order Release service operation. The WMS picks, packs, and ships the order and sends the details back to PeopleSoft using the Inventory Pick Confirm service operation or the Inventory Shipping service operation. PeopleSoft then completes the costing and billing steps:

The following diagram illustrates the order-to-cash flow between PeopleSoft and a WMS

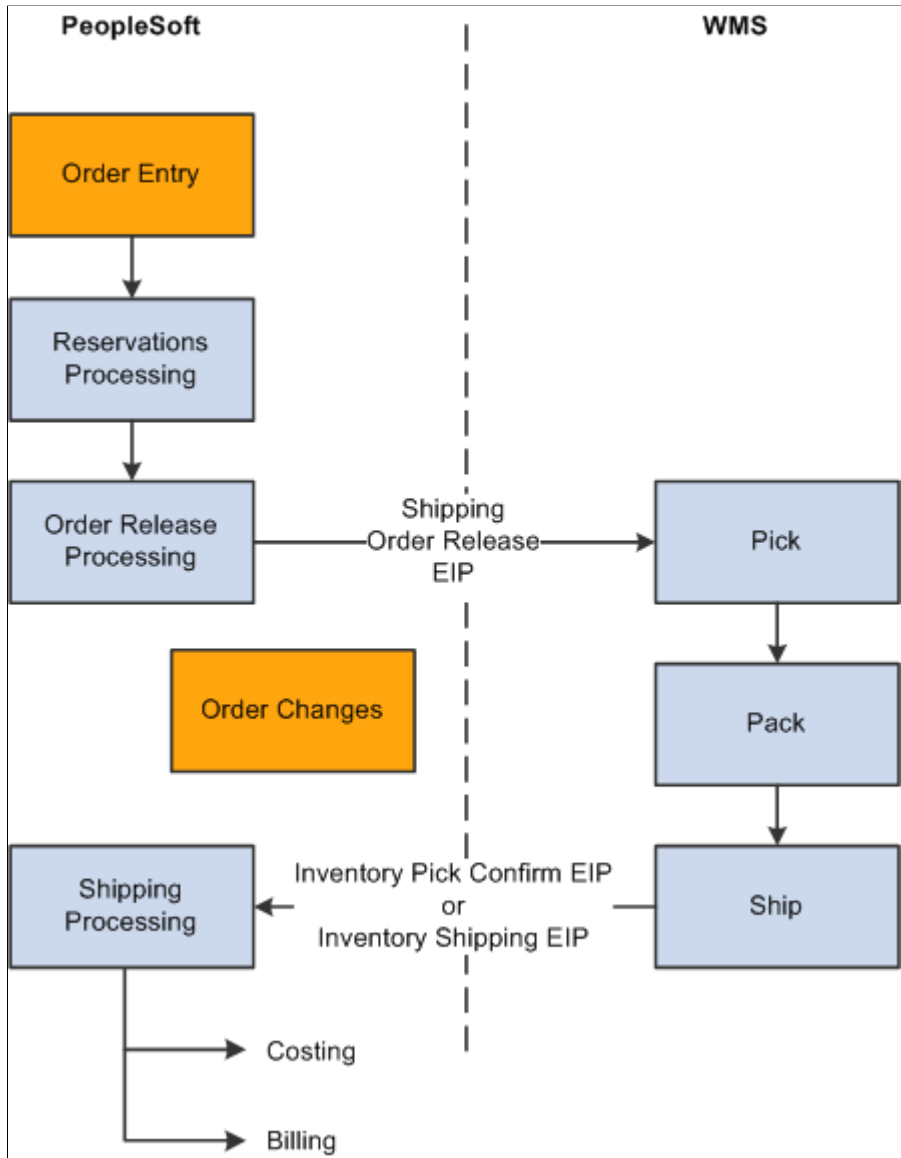

The EIPs that support the order-to-cash business process in a WMS integration are based on a number of assumptions. The following sections detail the assumptions for each phase of the order-to-cash business process.

Order Entry

In a WMS integration, orders are captured and staged for fulfillment in PeopleSoft tables. PeopleSoft Inventory enables you to capture demand for stock from many sources, including sales order entry functions in PeopleSoft Order Management and material stock requests accepted from other PeopleSoft business units and third-party applications.

Regardless of demand source, all orders that are staged for fulfillment in the PeopleSoft Inventory the demand fulfillment table, IN_DEMAND, can be processed in a WMS. However, orders issued with the Creating Express Issue Stock Requests in PeopleSoft Inventory cannot be processed in a WMS. Express issue orders bypass picking, packing, and shipping functions are directly inserted into the PeopleSoft Inventory history table, TRANSACTION_INV.

Related Links

"Understanding Methods of Order Creation" (PeopleSoft Inventory)

"The Order Fulfillment Process" (PeopleSoft Inventory)

"Understanding Sales Order Entry" (PeopleSoft Order Management)

Reservation Processing

Before the order can be released for picking in a WMS, the demand line must set to the *releasable* fulfillment state by reservation processing in PeopleSoft Inventory. A demand line can be set to the releasable state with soft-reserve, ATP promise, pre-allocation, or just released downstream for picking. A demand line could be fully or partially back-ordered by the reservation process.

Pre-allocations

Pre-allocations are a hard allocation of quantity at the material storage location level when orders are in the unfulfilled state. Pre-allocations include hard allocations created by the pegging feature and lot-allocations. In PeopleSoft Inventory, the Order Release Request process is run to generate the Shipping Order Release EIP. This service operation sends the hard allocations to the WMS. If PeopleSoft Inventory receives a transfer transaction for a pre-allocated item from the WMS, the transaction is rejected because allocated material cannot be transferred. Do not use pre-allocation processing if the WMS implementation has procedures that require transferring material from a material storage location to a shipping area before sending data using the Inventory Pick Confirm EIP or the Inventory Shipping EIP.

Back Orders

If back orders are permitted for orders, the back order processing takes place in PeopleSoft Inventory. Back order functionality in the WMS is not used in a WMS integration. If you allow order lines to ship with partial quantities, demand lines with the available portion of the requested quantity are inserted into IN_DEMAND, where they can be released for picking in the WMS.

Related Links

"Understanding Inventory Reservations" (PeopleSoft Inventory)

Order Release Processing

In a WMS integration, running the Order Release process in PeopleSoft Inventory releases eligible orders to the WMS to be picked, packed, and shipped. For PeopleSoft Inventory business units under external warehouse control, the Order Release process using the Shipping Order Release output option, sends the order data to the WMS using the Shipping Order Release EIP.

The sort selections available from the Additional Options page of the Order Release process do not control the sequence of the orders in the Shipping Order Release service operation. The order data sent to the WMS is separated into logical orders based on breaks in the following sort sequence:

1. Business unit.
2. Demand source.
3. Source business unit.
4. Order number.

5. Customer ID.
6. Ship to ID.
7. Address sequence code.
8. Carrier ID.
9. Ship via.

Note: If the Ship Using TMS Reference ID check box is selected on the Inventory Definition page then the orders released to the WMS system will be set up and sorted using the TMS Reference ID and TMS Reference ID Line Number.

Note: If the address information for an order is modified before order release, the address fields are added to the sort sequence.

For each logical order, there is a single order header that contains the address and shipping information for the order. The Order Release process assigns an external reference number to the order header. For each Order Release process run, the external reference numbers are assigned to order headers sequentially starting with 1. This number is also referenced on each demand line associated with the order header and can be viewed on the Stock Requests Inquiry page. The combination of the external reference number and the pick batch ID provides a unique key that the WMS uses to identify a specific order release transaction.

The data sent by the Shipping Order Release service operation contains detailed information for each line on the order, including details of quantities allocated to specific items and material storage locations. Lot detail for lot-allocated demand lines is always provided; however, quantity allocation for push picking plans is provided on an optional basis only.

The order release transaction in a WMS integration is the same for both pull and push picking plans. However, if you use a push picking plan (Create Allocations action on the Order Release process page), the quantities are allocated at the material storage location level. If PeopleSoft Inventory receives a transfer transaction for an allocated item from the WMS, the transaction is rejected because allocated material cannot be transferred. Push picking plans should not be used if the WMS implementation has procedures that require transferring material from a material storage location to a shipping area before sending the data using the Inventory Pick Confirm EIP or the Inventory Shipping EIP.

To delete an order line from a pick batch ID, you must manually delete the line in both PeopleSoft Inventory and the WMS. To delete the order line in PeopleSoft Inventory, use the Material Picking Feedback page. (This is the only circumstance in which the Material Picking Feedback page is used in a WMS integration.) If you do not also delete the order line in the WMS system and the line is returned to PeopleSoft Inventory on an Inventory Pick Confirm EIP or an Inventory Shipping EIP, the line is rejected because it is no longer associated with the order.

The Shipping Order Release EIP does not include substitute item detail as provided on picking plans in PeopleSoft Inventory. However, all other notes tied to a picking plan are included in this data. In addition, the Shipping Order Release EIP includes any notes associated with the bill of lading to support WMSs that print their own bills of lading.

Related Links

[PeopleSoft SCM Inbound EIPs](#)

"Understanding the Picking Process" (PeopleSoft Inventory)

Order Changes

In general, once an order is released to the WMS, any changes made to the order in either the WMS or in the PeopleSoft system must be manually communicated between the two systems. The PeopleSoft system does not send any order change information to the WMS. Changes made to the order shipping information in the WMS for the carrier, shipping method, and freight terms are sent to the PeopleSoft system as part of the Inventory Pick Confirm EIP or the Inventory Shipping EIP. Any other order changes made in the WMS, however, must be manually duplicated in the PeopleSoft system.

You can cancel an order line at any time until the order line has the status *Shipped* in PeopleSoft Inventory. However, in a WMS integration, first cancel the order in the WMS and then cancel the order in the PeopleSoft system using the Cancel/Hold Stock Request page. If an order canceled in PeopleSoft Inventory is actually shipped in the WMS, PeopleSoft Inventory rejects the transactional data from the Inventory Pick Confirm EIP or the Inventory Shipping EIP received from the WMS. You cannot reverse an order cancellation in PeopleSoft Inventory.

Related Links

"Understanding Changing, Canceling, and Holding Orders" (PeopleSoft Inventory)

Shipping Processing

When the WMS ships an order, it sends shipping information to the PeopleSoft system using the Inventory Shipping EIP. This service operation contains all the information necessary to pick, pack, and ship individual orders in the system tables. In addition to providing basic information, the transaction creates single-level shipping containers and ship serial IDs.

The Inventory Pick Confirm EIP may be used in place of the Inventory Shipping EIP if the actual shipping action will occur in the PeopleSoft system. This EIP provides all information necessary to pick and relieve bin location inventory balances but does not ship orders. Information necessary to create single level shipping containers and ship serial IDs may also be provided on this EIP.

A third alternative for providing shipping information is the Shipping Notification EIP. In prior releases, the Shipping Notification EIP was used to send back picking and shipping details from the WMS system. The Shipping Notification EIP is available for backwards compatibility to earlier releases. However, if you are currently implementing the integration point between PeopleSoft Inventory and a WMS, use the Inventory Pick Confirm or the Inventory Shipping EIP instead of the Shipping Notification EIP.

No matter which of the above three EIPs are used, shipping information overriding carriers, shipping methods and freight terms can be entered on the transactional data if changes were made at shipping time. In addition, a unique Ship ID can be assigned to each shipment coming from the WMS system. However, if the Ship ID is left blank, the system will automatically assign a shipping ID as the order is shipped.

Note: A single release order line cannot be split across two different shipping IDs.

Shipping Notification EIP

The system converts the Shipping Notification EIP to either an Inventory Pick Confirm or Inventory Shipping transaction as the data is processed by the subscription process assigned to the Shipping Notification EIP. The original Shipping Notification data is written to the transaction log (BCT_CTL and BCT_DTL) in a complete status for audit purposes only. The system also writes the Inventory Pick Confirm or Inventory Shipping transaction data to the transaction log.

The shipping notification EIP includes the shipment header and shipment lines. A shipment designated by a shipment header is defined as a shipment event for a single carrier ID, ship type ID, freight terms value, ship date, ship time, and bill of lading. These field values must be identical for all lines defined for the given instance of a shipment header.

Shipping History and Documentation

PeopleSoft collects and tracks shipping history based on the information from the Inventory Pick Confirm EIP or the Inventory Shipping EIP. If a bill of lading number is sent to PeopleSoft Inventory in the data, the PeopleSoft system updates the demand fulfillment table, IN_DEMAND, for tracking purposes only. A bill of lading is not created in the PeopleSoft system.

In a WMS integration, the required shipping documentation is usually generated using the WMS; however, you can also generate this documentation using PeopleSoft components.

Related Links

[PeopleSoft SCM Inbound EIPs](#)

"Entering Picking Feedback Using an Electronic Data Collection System" (PeopleSoft Inventory)

"Understanding the Shipping Business Process" (PeopleSoft Inventory)

"The Order Fulfillment Process" (PeopleSoft Inventory)

The Procure-to-Pay Business Process in a WMS Integration

This section discusses:

- Requisitions.
- Purchase orders.
- Purchase order expected receipts processing.
- Receiving.

The procure-to-pay business process enables companies to buy goods and services from their suppliers. Here is an overview of the process in a WMS integration:

1. PeopleSoft components are used to manage stock replenishment, create requisitions and purchase orders, and automatically source and dispatch the purchase orders.
2. When the requested stock on purchase orders arrives, the WMS handles the receiving, inspection, and putaway transactions for the stock.
3. The PeopleSoft system provides costing and accounts payable functions.

Procure-to-Pay Process Flow in a WMS Integration

The following diagram shows how the procure-to-pay functions are performed in a WMS integration. PeopleSoft creates and dispatches the purchase order or the interunit stock request. The Purchase Order Expected Receipts service operation or the Interunit Expected Receipt service operation is used to send expected receipt data to the WMS. The incoming stock is received and inspected by the WMS. The Purchase Order Receipt service operation or the Interunit Receipt service operation sends the receiving

information back to PeopleSoft where inventory putaway, costing, and accounts payable vouchers are processed:

The following diagram shows how the procure-to-pay functions are performed

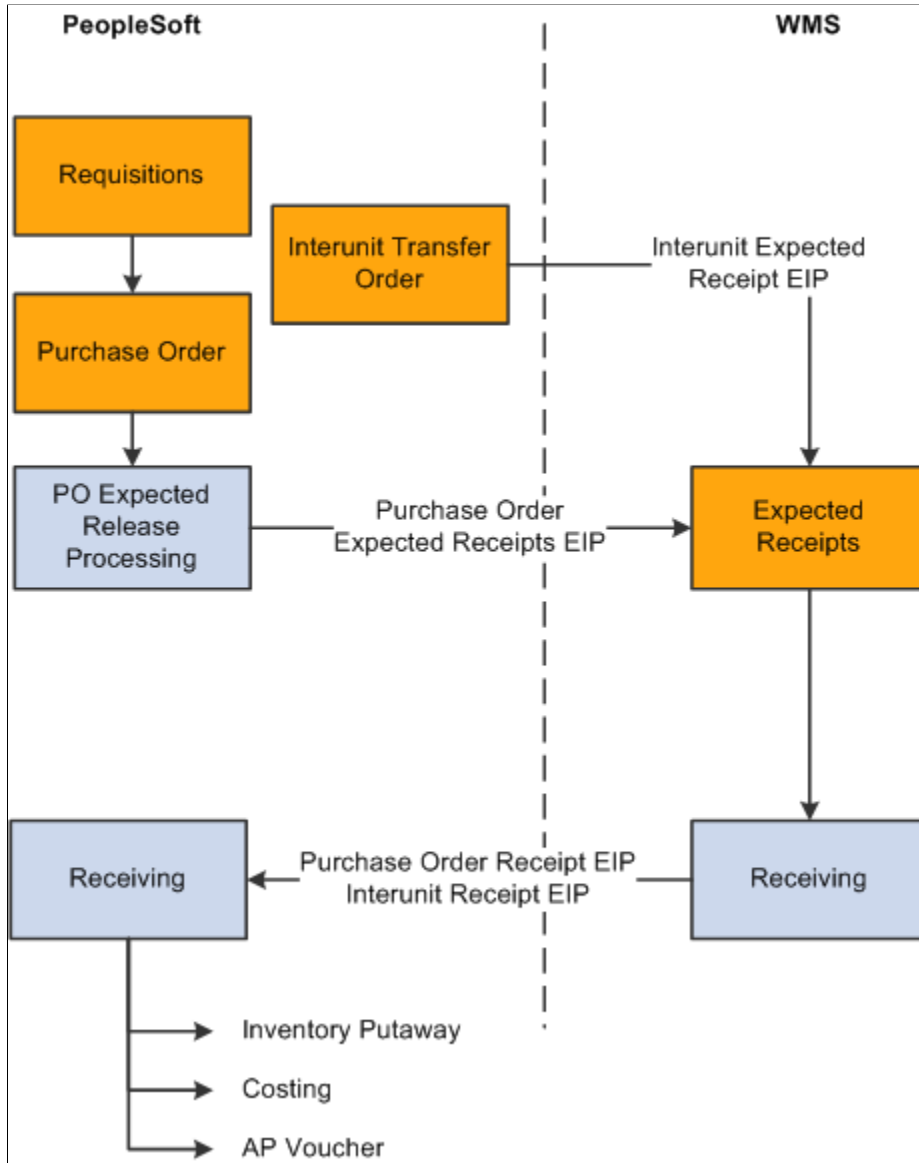

The EIPs that support the procure-to-pay business process in a WMS integration are based on a number of assumptions. The following sections detail these assumptions for each phase of the procure-to-pay business process.

Requisitions

Requisitions can be created in PeopleSoft Purchasing using a variety of methods. After a requisition is created, it moves through PeopleSoft Purchasing to become either a purchase order that is sent to a supplier or a demand that is staged in a PeopleSoft Inventory business unit. In a WMS integration, requisitions are created and maintained in the PeopleSoft system. Requisitions are not sent to the WMS.

Related Links

"Configuring Requisition Defaults" (PeopleSoft Purchasing)

Purchase Orders

As with requisitions, purchase orders can be created in PeopleSoft Purchasing using a variety of methods. After they are approved and sourced, purchase orders are dispatched to suppliers.

Related Links

"SUT Processing on the Purchase Order" (PeopleSoft Purchasing)

Purchase Order Expected Receipts Processing

For purchase orders that will be received by a business unit under external warehouse control, the PeopleSoft system publishes outbound information using the Purchase Order Expected Receipts EIP. When receiving the stock from a purchase order, the WMS matches the actual receipt against the data in the PO expected receipts transaction.

The transactional data in the PO Expected Receipt EIP is sent to the WMS for dispatched purchase orders that are expected to be received within a user-defined period. If a change is made to a purchase order that has been included in a previous PO expected receipts transaction, another expected receipts transaction is published when the change event occurs. This includes closing or canceling the purchase order. When the WMS receives a PO expected receipts transaction for a purchase order with a *Closed* or *Canceled* status, the corresponding PO expected receipt transaction in the WMS can also be closed or canceled.

The PO expected receipts transaction includes purchase order header, order line, schedule line, and comment information. The PO expected receipt line segment includes an order quantity field that represents the total of the associated schedule lines. The schedule line segment contains a combination of specific purchase order line, schedule, and distribution information. Purchase order comments and notes segments are provided at the header, line, and schedule levels.

Note: The order quantity on the receipt line is provided for WMSs that cannot handle the three-level purchase order structure (header, line, and schedule). In this case, the WMS uses the purchase order line-level receipt variation (Transaction Code 0103) of the purchase order receipt transaction.

In the PeopleSoft system, there are two service operations that make up the Purchase Order Expected Receipt EIP:

- The first service operation (PO_EXPECTED_RECEIPT_BUS_UNIT) contains PO expected receipt information for a specific PeopleSoft Inventory business unit.

For example, you may have a single purchase order line with an order quantity of 75 units that are distributed among three different PeopleSoft Inventory business units for a quantity of 25 units each. Three different purchase order expected receipt transactions containing an order line quantity of 25 are generated, one for each inventory business unit. This is the transaction that is used in most WMS implementations, because most WMSs expect purchase order information for the specific business unit under their control.

- The second service operation (PO_EXPECTED_RECEIPT_SHIPTO) contains PO expected receipt information for a specific ship to location.

In this case, the PO expected receipts are grouped by ship to location instead of business unit. Using this second type of purchase order expected receipt transaction in the preceding example, the system generates a single transaction for a total quantity of 75 units.

The Publish Outbound Message process publishes the purchase order expected receipt data for all PeopleSoft Inventory business units or ship to locations on purchase orders that meet specified selection criteria.

Only the Process Outbound Message process publishes purchase order expected receipt data. An expected receipt transaction cannot be generated from the Return to Vendor - RTV page. This constraint has the following implications for a WMS integration:

- When you reopen a purchase order in PeopleSoft, no transaction is sent to the WMS to reopen the purchase order; however, if you make a change to the reopened purchase order, the system sends a PO expected receipt message to the WMS, where the purchase order has a *Closed* status.

To resolve this discrepancy, you can set up the WMS to reopen a purchase order automatically if a PO expected receipt transaction is received for a closed purchase order. Alternatively, for business units under WMS control, the option to reopen purchase orders for supplier returns, **RTV Reopen PO**, can be disabled in the PeopleSoft system on the Purchasing Definition - Business Unit Options page.

- When you perform a vendor return in PeopleSoft Purchasing, you can return a quantity for replacement.

When you select the return-for-replacement option, the quantity that was received is reduced by the quantity you are returning for replacement. This logic makes the open quantity on the purchase order equal to the returned quantity. However, because no PO expected receipt data is sent to the WMS from the Return to Vendor - RTV page, the new open quantity is not reflected in the WMS. To resolve this discrepancy, you can either:

- Enable the WMS to over-receive, this will allow receipts greater than the original order quantity.

This solution requires that the WMS be able to receive against a closed purchase order. If the purchase order was originally closed in the PeopleSoft system and then reopened from the RTV page, the status of the purchase order remains closed in the WMS.

- Disable the RTV Adjust Source option on the Purchasing Definition - Business Unit Options page.

When you disable this option, the receipt quantity (Net Receive Qty) is not decreased when you return for replacement from the Return to Vendor - RTV page. With this solution, after entering the return-to-vendor information, you add a new schedule for the replacement quantity on the Purchase Order - Form page. The change on the Purchase Order Form page generates PO expected receipt information, which provides the WMS with an open quantity against which to receive.

Interunit Transfer Expected Receipts Processing

Interunit transfer orders are created in the PeopleSoft system to move stock between business units. The Interunit Expected Receipt EIP is an asynchronous outbound service operation (INTERUNIT_EXPECTED_RECEIPT). The transactional data is generated by the Process Outbound Message process using this EIP when an interunit transfer order has a destination business unit that is under external warehouse control and the transfer order is depleted. The WMS uses the information

from the interunit expected receipt EIP to validate the receipt of goods when the shipment arrives at the destination warehouse.

The interunit expected receipt EIP includes receipt header information and receipt lines with details of each item that was shipped.

In PeopleSoft Inventory, you can cancel in-transit interunit transfer orders using the Cancel Interunit Transfers page. For transfer orders that have been sent out on previous interunit expected receipt transaction, the cancellation transaction generates an interunit expected receipt transaction with a status of *Cancel*.

Related Links

"Creating Requisition Lines" (PeopleSoft Purchasing)

"Understanding Stock Transfers Between Business Units" (PeopleSoft Inventory)

Receiving

In a WMS integration, all receiving, inspection, and putaway activities are performed using the WMS. To confirm that stock has been received for a purchase order or an interunit transfer, the WMS sends a receipt confirmation transaction to the PeopleSoft system using the Purchase Order Receipt EIP or the Interunit Receipt EIP.

For both purchase order and interunit receipts, the receipt confirmation transaction includes header information and receipt lines with details about what was physically received at the business unit under WMS control.

The WMS can include the receipt ID and receipt line number in either of the receipt confirmation transactions. To ensure that receipt IDs assigned by the WMS are unique, define a range of ID numbers during implementation for exclusive use by the WMS. If the receipt ID is not included on the confirmation, the PeopleSoft system generates one automatically.

If either of the receipt confirmation transactions includes the material storage location data, the item is put away to the specified material storage location. Otherwise, the item is put away using the putaway rules defined for the business unit.

Blind receipts from a WMS are not accepted. All receipt confirmation data that the WMS sends must have a valid purchase order number or interunit ID number.

In PeopleSoft Purchasing, the Receiver Load process (PO_RECVLOAD) processes the purchase order receipt confirmation transactions. The Receiver Load process can accept purchase order receipts at either the purchase order line or schedule level. During a WMS implementation, consider these processing rules when deciding how best to use this functionality:

- When working at the schedule level, the Receiver Load process receives the full quantity against a given schedule line number.

When working at the line level, the Receiver Load process applies the full quantity received to the first open schedule for that line unless the Allow Receipt Load Cascade option is enabled to cascade receipts across multiple schedules. If the cascading feature is enabled, any full quantity is applied to the first schedule, and any excess quantity is applied to the next schedule, and so on until the full quantity is consumed. You set the Allow Receipt Load Cascade option on the Purchasing Definition - Business Unit Options page.

- The inventory business unit is included in the receipt transaction to associate the receipts to the appropriate distribution line.

If the inventory business unit is included on the transaction, the receipt affects only the quantity for the business unit's distribution line. If the inventory business unit is blank, the quantity received is received against each distribution line until the entire quantity for the schedule is received.

The Interunit Receiving process (INPJIURV) processes the interunit transfer receipt confirmation transactions. When an interunit receipt is completely received and closed, an interunit expected receipt transaction is generated with a status of *Received*. The *Received* status on the transaction indicates that the transfer order can be closed in the WMS system.

Related Links

"Understanding Receiving and Putaway Processing" (PeopleSoft Inventory)

"Understanding the Receiving Business Process" (PeopleSoft Purchasing)

Four-Wall Warehousing Functions in a WMS Integration

This section discusses:

- Inventory adjustments.
- Storage location transfers (inventory status updates).
- Physical inventory (stock quantity snapshots).

Four-wall functions are material management activities bounded by the four walls of a specific warehouse, including performing cycle counts and full physical inventory counts, adjusting quantities for specific material storage locations, replenishing fixed picking locations, and making any other stock transfers between material storage locations. In a WMS integration, all four-wall functions are performed in the WMS and then reported to the PeopleSoft system by using EIPs.

Process Flow for Four-Wall Warehousing Functions in a WMS Integration

The following diagram shows the process flow for four-wall EIPs in a WMS integration. The WMS performs any wall-to-wall inventory counts or cycle counts and then passes the data to PeopleSoft Inventory using the Physical Inventory service operation. The WMS also performs any warehouse transfers or stock adjustments and passes this information to PeopleSoft using the Inventory Transfer service operation and the Physical Inventory service operation:

The following diagram shows the process flow for four-wall EIPs in a WMS integration.

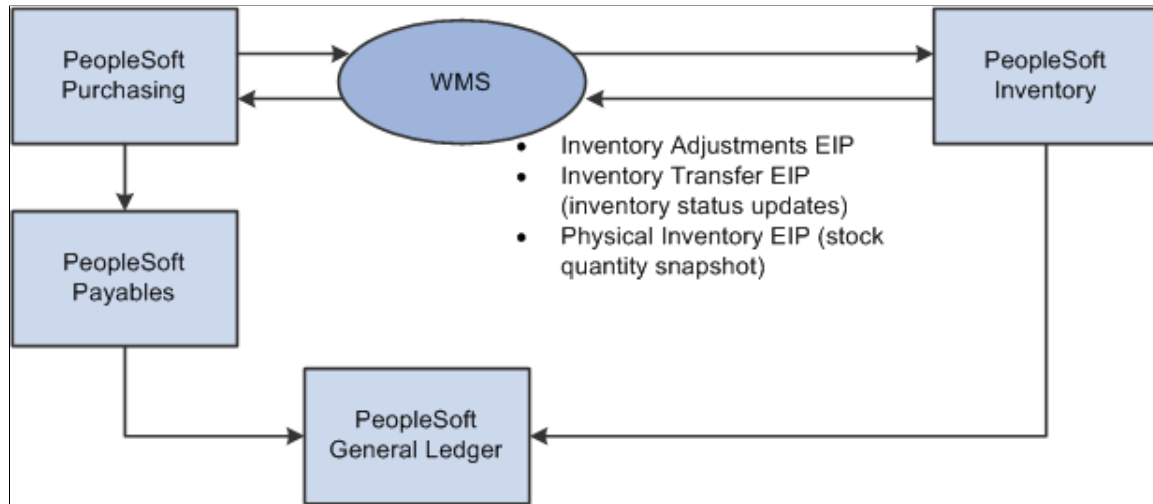

The EIPs that support the four-wall functions in a WMS integration are based on a number of assumptions. The following sections detail the assumptions for each function.

Inventory Adjustments

Inventory quantity adjustment transactions are generated from the WMS using the Inventory Adjustment EIP. The inventory adjustment transaction notifies PeopleSoft Inventory of quantity changes required for defective, found, or lost stock. This transaction is a simple quantity adjustment for an item in a particular material storage location.

Distribution types on the adjustment transaction are used for inventory accounting. Some WMSs have charge codes that match up to the distribution type fields. However, if the WMS charge codes differ from the distribution types established in PeopleSoft Inventory on the Distribution Type page, the WMS charge codes must be converted to match the PeopleSoft distribution types when the transactional data is mapped. If the distribution type field is left blank, the PeopleSoft system uses the default distribution type established for the selected adjustment type on the Default Distribution Type page.

Note: ChartField overrides are not permitted for adjustment transactions.

Storage Location Transfers (Inventory Status Updates)

To notify PeopleSoft Inventory of material transfers between material storage locations, the WMS generates inventory transfer data using the Inventory Transfer EIP. In a typical WMS integration in which quantity balances are tracked only at the business unit level in the PeopleSoft system, the inventory transfer data sent to the PeopleSoft system change the status of the stock to *Open* or *Hold*. In PeopleSoft Inventory, two storage locations are defined in the PHYSICAL_INV table: one for quantity with an *Open* status and another for quantity with a *Hold* status. Inventory status change transactions originating from the WMS must be translated to map to the EIP by identifying the *Open* and *Hold* locations that are used in the PeopleSoft system.

Physical Inventory (Stock Quantity Snapshots)

To synchronize quantity balances between the two systems, the WMS uses the Physical Inventory EIP to send PeopleSoft Inventory a stock quantity snapshot transaction that reflects the current stock quantity balances for the business unit. In PeopleSoft Inventory, this data is processed as a physical inventory transaction. You can use the quantity balances in this inbound data to run a reconciliation report and stock quantity update process, just as you would for a cycle or physical count performed for an PeopleSoft Inventory business unit that is not integrated with a WMS.

Because the success of the WMS integration relies on synchronous quantity balances between the two systems, a quantity balance synchronization procedure should be performed as often as feasible.

Synchronizing Quantity Balances

Here are steps for synchronizing quantity balances between PeopleSoft Inventory and a WMS:

1. In the WMS, perform a counting event and use the Physical Inventory EIP to send PeopleSoft Inventory a transaction that reflects the current quantity count.

A counting event can be for all items in the WMS or for a specific item, lot, or material storage location. Each stock quantity snapshot includes header information for the counting event and lines detailing the count quantity and material storage location information for each item counted. When the data is received, PeopleSoft Inventory loads the counting event data into the electronic data collection transaction tables.

Note: The data sent using the Physical Inventory EIP is used to perform periodic checks of the quantity balance synchronization between the two systems. There is no expectation that an actual cycle count or physical inventory count has occurred in the WMS. The Physical Inventory EIP is not used to communicate quantity balance changes from a physical inventory or cycle counts in the WMS. In these cases, the WMS sends PeopleSoft Inventory an adjustment using the Inventory Adjustments EIP.

2. Run the Physical Inventory process (INPIPHYS) to move the counting event data to the count table (COUNT_INV) in PeopleSoft Inventory.

Set up run control parameters for the Physical Inventory Load process on the Physical Inventory Process page under the SCM Integrations menu.

3. Run the Physical Accounting Reconciliation report to detect any discrepancies between the two systems.

Set up run control parameters for the Physical Accounting Reconciliation report on the Reconciliation Report page. If you find a discrepancy and do not want to accept the adjustment, you can use the Item Counts page to change the status of the counting event line to exclude it from the Stock Quantity Update process (INPOPOST).

4. Run the Stock Quantity Update process to update the quantities in PeopleSoft Inventory.

Set up run control parameters for the Stock Quantity Update process on the Stock Quantity Update Process page.

Related Links

"Understanding Counts" (PeopleSoft Inventory)

Static Information Updates in a WMS Integration

This section discusses:

- Customer data.
- Supplier data.
- Item data.
- Carrier and shipping method data.
- Location data.

Static information includes data about customers, suppliers, items, carriers, and locations. In a WMS integration, all static information is maintained in the PeopleSoft system and update information is sent to the WMS as necessary. If a change is made to any part of the static information in the PeopleSoft system, even to a field that does not exist on the outbound message, information indicating a change event is sent to the WMS.

Process Flow Static Information Transfers in a WMS Integration

The following diagram shows the process flow for static information transfers between a WMS and PeopleSoft, including customer, supplier, item, carrier, shipping method, and location table data:

The following diagram shows the process flow .

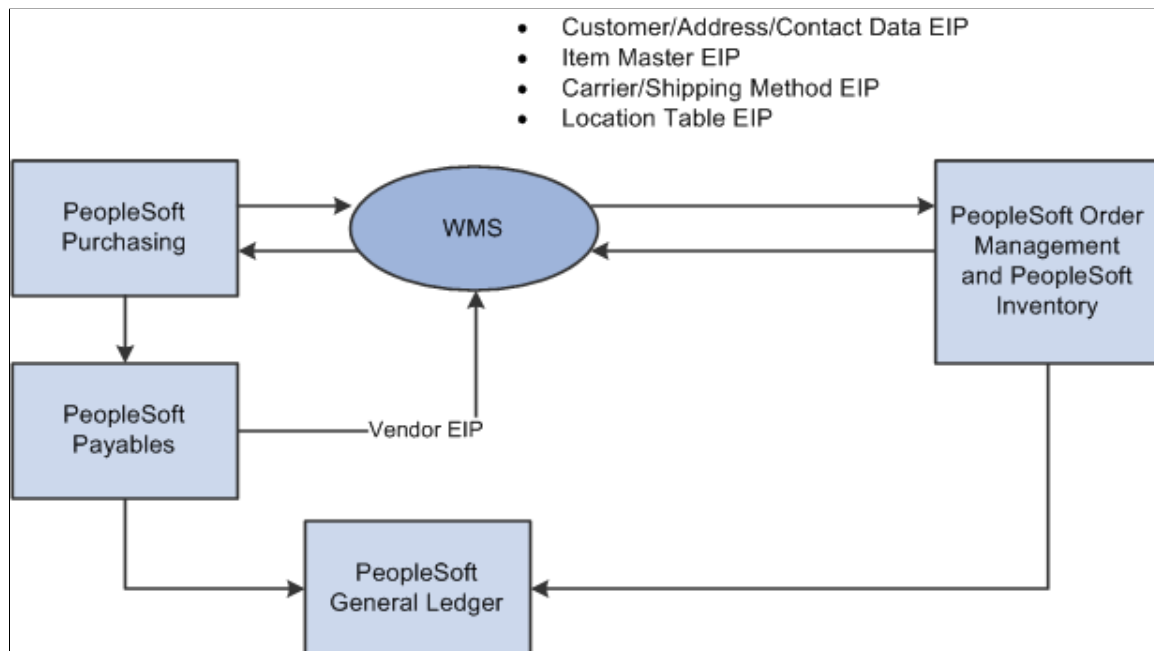

The EIPs that support the static information updates in a WMS integration are based on a number of assumptions. The following sections detail these assumptions for each static data type.

Customer Data

Using the Customer/Address EIPs, the PeopleSoft system publishes updates for customer-related information to the WMS when a customer record is created, changed, or inactivated. These EIPs includes customer master and address information and may be filtered based on the PeopleSoft SetID.

Related Links

"Understanding Customer Control Information" (PeopleSoft Order to Cash Common Information)

Supplier Data

Using the Supplier EIP, the PeopleSoft system publishes updates for supplier-related information to the WMS when a supplier record is created, changed, or inactivated. The information may be filtered by the PeopleSoft SetID.

Related Links

"Understanding Supplier Maintenance" (PeopleSoft Source to Settle Common Information)

Item Data

Using the Item Master EIP, the PeopleSoft system publishes updates for item-related information to the WMS when an item record is created and set to an approved status, or when changes are made to the item after it has reached an approved status. The data includes item master, item detail, unit of measure, purchasing attributes, business unit attributes, and business unit weight and volume information for approved items only. The item data may be filtered by both the PeopleSoft SetID and business unit.

Related Links

"Defining Items at the SetID Level" (PeopleSoft Managing Items)

Carrier and Shipping Method Data

Using the Carrier/Shipping Method EIP, the PeopleSoft system publishes updates for carrier-related information to the WMS when a carrier record is created or changed. The transaction includes carrier master information and is filtered by the PeopleSoft SetID.

Related Links

"Carrier Page" (Application Fundamentals)

Location Data

Using the Location Table EIP, the PeopleSoft system publishes updates for location-related information to the WMS when a location record is created or changed. The data includes location master information and is filtered by the PeopleSoft SetID. The locations are established on the Location - Location Definition page in the PeopleSoft system to identify the address of an internal location that can receive interunit transfer orders. The WMS uses the location on interunit transfer orders as it would the customer ID on customer sales orders.

Chapter 6

Integrating With a Third-Party Point-of-Use Supplier System

Understanding POU Supplier Systems

This section discusses:

- General assumptions about POU supplier systems.
- Definition of items and par locations.
- Chunking Rules for streamlining POU supplier integration processes.
- POU suppliers as par locations in PeopleSoft Inventory.
- Returns to vendors (RTVs) for POU supplier items.

You can integrate PeopleSoft Inventory par location functionality with POU supplier systems. This integration consists of generic EIPs, using service operations in PeopleSoft Integration Broker to exchange applicable par location, item counts, and expected receipt information between the PeopleSoft system and the POU supplier.

This topic describes the implementation of a full integration between POU medical supply dispensing cabinets and PeopleSoft. The use of POU supplier systems for issuing medical supplies is prevalent in today's typical hospital environment. POU supplier systems maintain available stores of medical supplies for the immediate and ad hoc needs of a hospital's surgical, nursing, and distribution staff during normal operations. A POU supplier system maintains on-hand quantities at all times and records patient usage as it occurs.

A POU supplier system can be a complete standalone system, but it is usually integrated with a hospital's materials management information system (MMIS), such as PeopleSoft Inventory and PeopleSoft Purchasing. Integrating a POU supplier system with an MMIS can help a health care organization achieve maximum benefit from its investments on both fronts.

In this integration scenario, the PeopleSoft system is responsible for:

- Defining and maintaining the par location and item information.
- Issuing stock from inventory to the par locations.
- Performing the receipt of purchased goods.
- Replenishing the materials to the par locations.

The POU supplier systems are responsible for:

- Keeping track of the stock on hand in the POU locations.

- Capturing the use of the medical supplies issued.

That use can in turn be charged directly to a specific patient's account. If the charges are made directly to patient accounts, the POU supplier system is also usually integrated with the hospital's patient accounting or clinical systems.

Assumptions About POU Supplier System Integration

The POU supplier system integration works as designed only if you understand the following assumptions and your system complies with them:

- Because patient usage is recorded in the POU supplier system and not in PeopleSoft Inventory, the material usage and reconciliation feature in PeopleSoft Inventory should not be used.

Any reconciliation procedures must be handled by the POU supplier system.

- If you use POU supplier systems in some locations and PeopleSoft Inventory par locations in others, and if you plan to use the consumer usage feature, you need to set up two feeds to the admission, discharge, and transfers and patient billing systems: one from PeopleSoft and one from the POU supplier system.
- If a POU supplier is reconfigured, for example, if bins are removed, added, or moved, the physical reconfiguration of the POU supplier needs to occur first, followed by the manual online maintenance of the par location in PeopleSoft Inventory.

The Par Location EIP transactions are then published to update the supplier accordingly.

- All par locations, whether integrated with a POU supplier system or not, are replenished using the PeopleSoft Inventory Create Par Replenishment Requests process (INPGCDMD).

Definition of Items and Par Locations for a POU Supplier Integration

All item and par location data is set up and maintained in the PeopleSoft system. However, a successful integration with a POU supplier depends on understanding how the POU supplier system uses the fields that you define in the PeopleSoft system. Here are two important points to keep in mind:

- The charge code and the usage tracking method (charge type) are required fields for every item in the par location for use with POU supplier systems.

Because the POU suppliers pass patient usage information directly to a patient billing system, these two pieces of information are vital. Both fields are part of the par location definition created in the Par Location Definition component, and they are included in the par location data that PeopleSoft Inventory sends to the POU supplier system.

- The same item can exist in a par location in both the PeopleSoft system and POU supplier system.

The compartment in the PeopleSoft system and the bin in the POU supplier both identify the unique location of an item in the POU par location. The POU supplier's bin is a system-generated, assigned field and the PeopleSoft system's compartment field cannot be fed into it. The POU supplier system needs to process the PeopleSoft compartment information separately to avoid data update conflicts.

Related Links

"Understanding the Material Usage and Reconciliation Business Process" (PeopleSoft Inventory)

Chunking Rules for Streamlining POU Supplier Integration Processes

You can use the PeopleSoft chunking methodology to reduce the volume of data that are sent in the outbound publishing process. Chunking enables you to segment a transaction by business unit and location or par location and define which nodes receive the specific information. This functionality is especially helpful if not all of your subscribing nodes need to receive the data published by all departments. For example, you can set up processes so that business units and locations that exist as subscribers in third-party systems receive only the data that are specifically published for them according to the chunking rules and node maps that you implement.

PeopleTools: Integration Broker

POU Suppliers as Par Locations in PeopleSoft Inventory

Rather than setting up POU suppliers as PeopleSoft Inventory business units, you can set up your system to track POU suppliers as par locations within PeopleSoft Inventory. In this case, par location replenishment transactions for affected items must be subject to the same replenishment rules in PeopleSoft Inventory or PeopleSoft Purchasing.

However, the PeopleSoft system is not responsible for consumer charges because POU supplier systems pass this information to the consumer accounting system. The direct purchase and direct inventory issue processes to the POU suppliers should remain as originally designed in the PeopleSoft system.

Related Links

"Understanding Par Location Management" (PeopleSoft Inventory)

RTVs for POU Supplier Items

A PeopleSoft Purchasing RTV should be created if an incorrect item is delivered for replenishing a POU supplier. This kind of mistake is typically discovered at the main loading dock of the health care facility. However, if the item has already been received into PeopleSoft Purchasing, a transaction will have already been published to the POU supplier system. In this case, the POU supplier never receives the shipment and the system never fills the PO Receipt Notification transaction that is issued for the item.

Related Links

"Understanding the RTV Business Process" (PeopleSoft Purchasing)

Defining Par Location Data for the POU Supplier and the PeopleSoft System

This section discusses the procedures and application functions that are used to maintain par location data in PeopleSoft Inventory and the POU supplier system. Here are steps for defining and maintaining the par location data:

1. Decide on and document the specifications for the POU supplier configuration.

You build the POU supplier system based on the specifications (for example, compartment sizing, capacity, and so forth). Thoroughly document the system requirements.

2. Create par locations in the PeopleSoft system that correspond to the POU supplier.

Once you determine the configuration of the supplier and build the POU supplier system, create the corresponding par location in the PeopleSoft system by using the Par Location Definition component. You set up and maintain all item and par location data in the PeopleSoft system.

3. Run the Full Data Publish process to initially populate the POU supplier with item data.

Use the Full Data Publish process ((Enterprise Components, Integration Definitions, Initiate Processes, Full Data Publish) to publish a full-data replication of the par locations for the initial implementation by using the PAR_LOCATION_FULL_SYNC service operation (EIP). Run this process after the par locations are defined. This service operation is used to initially populate the POU supplier with par location item data.

4. Save changes to the Par Location Definition component to update the POU supplier.

All subsequent changes saved to the Par Location Definition component for existing par locations are sent to the POU supplier in partial-data replication (PAR_LOCATION_SYNC service operation) using the Par Location EIP. These partial-data replications are published when saving the Par Location Definition component to keep the POU supplier current with ongoing PeopleSoft Inventory par location definitions and item changes.

Related Links

[PeopleSoft SCM Inbound EIPs](#)

Managing Item Replenishment Data in the POU Supplier and the PeopleSoft System

This section discusses the procedures and application functions used to manage item replenishment data in POU suppliers and PeopleSoft. Here is the process for managing item replenishment data:

1. The POU supplier system tracks on-hand quantity and material usage.

The POU supplier system maintains on-hand quantities for each of its par location items set up in the PeopleSoft Inventory Par Location Definition component, and it records consumer material usage throughout the day.

2. The POU supplier system publishes on-hand par location count data to PeopleSoft Inventory.

The POU supplier uses the Par Location Count EIP to publish on-hand par location count data to PeopleSoft Inventory. This publication occurs at user-requested intervals from the POU supplier to provide the PeopleSoft system with current on-hand quantities for each item in the POU par locations.

3. PeopleSoft Inventory subscribes to the on-hand par location count data from the POU supplier system.

PeopleSoft Inventory uses the Par Location Count EIP to subscribe to this data. Once the data is received, the PeopleSoft system updates the par location count tables and the par location count information is ready to be processed using the Create Par Replenishment Requests process (INPGCDMD).

Note: Any existing POU supplier-based replenishment processes are not used in this integration.

4. Run the Create Par Replenishment Requests process (INPGCDMD) in PeopleSoft Inventory.

The Create Par Replenishment Requests process takes each par location count and replenishes items that fall below the par level that you identify on the Par Location Definition - Line page. A purchase order, requisition, or material stock request is created in the PeopleSoft system to replenish the stock to par levels.

5. Deplete the material stock requests created to replenish a POU supplier.

For material stock requests that have issued stock from inventory to the par location and have been depleted, the Internal Location Expected Receipt EIP publishes data to the POU application using the IN_PUB_MSG Application Engine process.

6. Receive direct-purchase items with the Receiving component in PeopleSoft Purchasing.

Receiving material against a purchase order in the Receiving component in PeopleSoft Purchasing triggers the publication of a data transaction to the POU supplier using the Purchase Order Receipt Notification EIP. This transaction identifies all direct-purchase items and quantities that have been received and are delivered to specified locations. The Receipt Push process (RECVPUSH) loads the stage table (RECV_PUSH_NTFY). If a chunking rule for the service operation and publish rule exists on the publish rule definition table (EO_MSGPUBDEFN), then the system creates staging records for only those par location receipt transactions that have the par location defined on the par location chunking table (IN_BU_PAR_EOC). If the chunking rule does not exist, then staging records are created for all par location receipt transactions. Once the stage table is loaded, it calls the program that in turn publishes the receipt notification data.

Related Links

[PeopleSoft SCM Inbound EIPs](#)

[Understanding SRS Applications](#)

"Replenishing Par Locations" (PeopleSoft Inventory)

Restocking a POU Supplier

This section discusses the typical procedure used to physically restock POU supplier systems. Here are the steps:

1. Generate the appropriate reports for the material to be restocked at the POU supplier.

Typically, the technician assigned to restock the POU supplier is prompted through the POU supplier restock event by the light guides on the POU supplier unit. The lights are activated based on the information in the data sent using the Internal Location Expected Receipt EIP (outbound) or Purchase Order Receipt Notification EIP (outbound).

For item issues out of inventory, the Shipping Document Report page (INC6503) can be requested to accompany the delivery of the stock items to the POU par location. For purchased items, the Receiver Delivery report (POY5030) can be generated to accompany the stockless and non-stock items to the POU par location.

The restock technician can then use these reports along with the light guides on the POU to ensure that the par locations are updated with the correct quantities.

2. Compare expected receipts with actual receipts, and record discrepancies.

When restocking a light-guided POU supplier, the technician follows the lights on the POU supplier and, for each item, verifies that the quantity displayed, or the expected receipt quantity, is the same as the actual quantity received. If the quantity received is different from the expected quantity, the technician records the variation on the report.

3. Manually restock the POU bin or compartment with the received stock.

The technician refills the bins or compartments in the POU supplier with the received stock.

4. Complete the restocking event in the POU supplier system.

The final step of the restocking event takes place in the third-party POU supplier system. Typically, the technician updates the POU supplier system with the actual quantities that are used to restock the POU supplier bins or compartments.

Using POU Supplier EIPs

Four EIPs (service operations in PeopleSoft Integration Broker) are used to exchange data between the PeopleSoft Inventory and the POU supplier systems. They are:

- Par Location EIP (outbound).
- Par Location Count EIP (inbound).
- Internal Location Expected Receipt EIP (outbound).
- Purchase Order Receipt Notification EIP (outbound).

Following the Data Flow Between the PeopleSoft System and the POU Supplier System

The following diagram illustrates the data flow between a POU supplier and PeopleSoft, including integration for par location counts, receipts, and internal location expected receipts:

The following diagram illustrates the data flow between a POU supplier and PeopleSoft

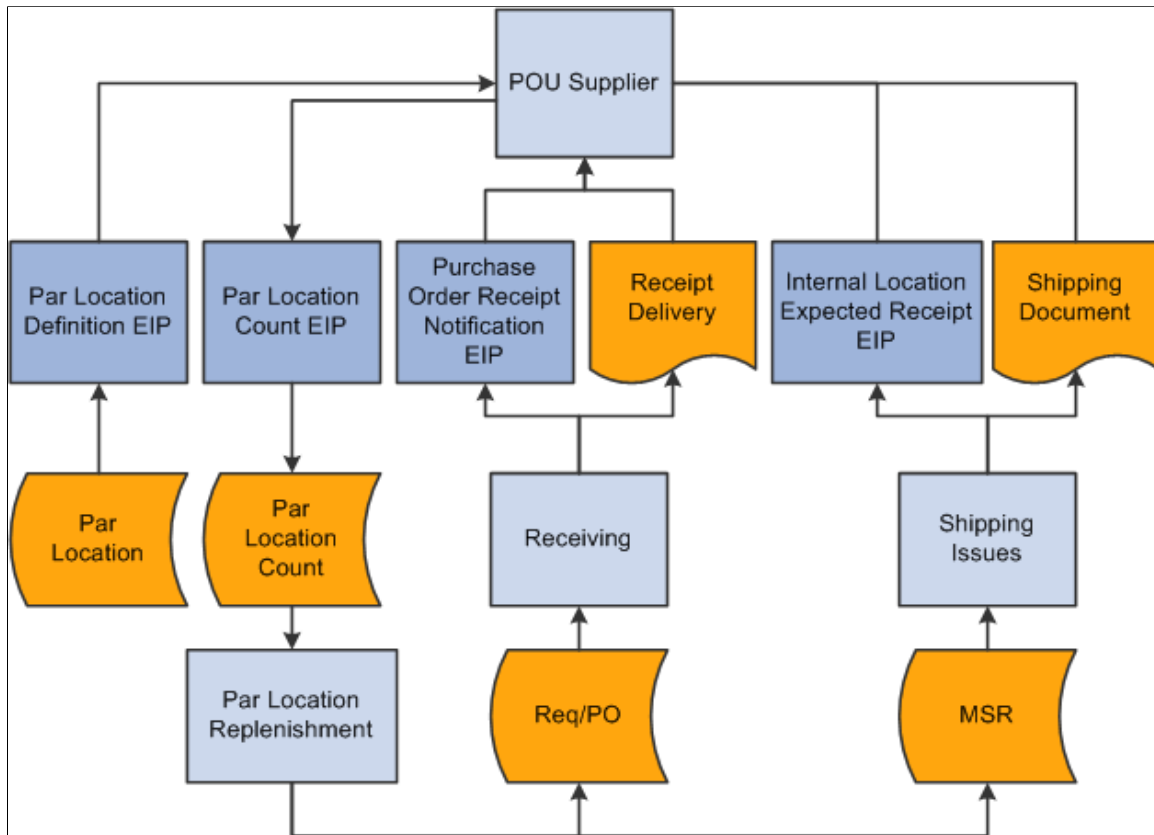

Related Links

[Defining Par Location Data for the POU Supplier and the PeopleSoft System](#)
[PeopleSoft SCM Inbound EIPs](#)

Managing Subscription Errors for POU EIPs

Error management is integral to the effectiveness of inbound EIPs in the PeopleSoft system. In the process of uploading data transactions, the PeopleSoft subscription process detects any data errors and stores them in queues or staging tables for manual correction in the PeopleSoft system before updating any core PeopleSoft application tables.

Each of the inbound EIPs facilitating the subscription of transactions from third-party applications has its own transaction code that must be entered on an assigned data management page to access the EIP's specific error-correction page.

The Par Location Count EIP, which is used in both surgical resource system and POU supplier system integrations, uses the transaction code *Par Loc*, which is entered on the Transaction Maintenance page. You use the Transaction Maintenance page to access error-correction pages for transactional data.

Related Links

[PeopleSoft SCM Inbound EIPs](#)

Integrating With a Third-Party Surgical Resource Software Application

Understanding SRS Applications

SRS applications:

- Manage a variety of medical resources.
 - Ensure that proper medical supplies are available at surgical facilities when needed.
 - Handle scheduling to ensure that physicians and supporting staff are available at the correct place and time to perform surgical procedures.
-

Defining Assumptions of an SRS Application Integration

The SRS application integration is based on the following assumptions:

- Because patient usage is recorded in the SRS application and not in PeopleSoft Inventory, the material usage and reconciliation feature in PeopleSoft Inventory should not be used.

Any reconciliation procedures must be performed in the SRS application.

- You set up dual feeds if you use an SRS application in some surgical resource locations and PeopleSoft Inventory par locations in others, and you use the patient usage feature in PeopleSoft.

Set up the two feeds from the admissions, discharges, and transfers and patient billing systems, one to the PeopleSoft system and one to the SRS application.

- All par locations, whether integrated with an SRS application or not, are replenished using the PeopleSoft Inventory Create Par Replenishment Requests process (INPGCDMD).

Related Links

"Replenishing Par Locations" (PeopleSoft Inventory)

Defining Items and Par Locations for an SRS Application Integration

All item and par location data is set up and maintained in the PeopleSoft system. However, a successful integration with an SRS application depends on understanding how the SRS application uses the fields that you define in the PeopleSoft system.

A charge code and usage tracking method (charge type) are required fields for every par location item that is used with an SRS application. Because the SRS application passes patient usage directly to a patient billing system, these two pieces of information are vital. Both of these fields are a part of the par location definition created in the Par Location Definition component, and they are included in the par location EIP transactions that PeopleSoft Inventory sends to the SRS application.

When you define a par location in PeopleSoft Inventory, the par location ID appears by default in the location field. For the SRS application integration, it is imperative that you do not overwrite this default value. When direct purchase requests are passed to PeopleSoft Purchasing through the Purchase Order Requisition EIP (PURCHASE_REQUISITION_LOAD service operation), the par location ID is used as the location.

Related Links

"Understanding the Material Usage and Reconciliation Business Process" (PeopleSoft Inventory)

Using Chunking to Streamline SRS Application Integration Processes

You can use PeopleSoft chunking methodology to reduce the volume of outbound data sent by the EIP. Chunking enables you to segment the data by business unit and location or par location and to define which nodes receive the specific information. This functionality is useful if only some of the subscribing nodes need to receive the data published by all departments. For example, you can set up your processes so that business units and locations that exist as subscribers in third-party systems receive only the data that are specifically published for them according to the chunking rules and node maps that you implement.

PeopleTools: Integration Broker

Related Links

[Setting Up Chunking](#)

Creating RTVs for Surgical Resource Par Location Items

A PeopleSoft Purchasing return to vendor (RTV) should be created if an incorrect item is delivered for replenishing a surgical resource par location. This mistake is usually discovered at the main loading dock of the healthcare facility. However, if the item has already been received into PeopleSoft Purchasing, a transaction will have already been published by the EIP to the SRS application. In this case, the surgical resource par location never receives the shipment and the system never fills the transaction from the PO Receipt Notification EIP issued for that item.

For technical details about individual EIPs, use the Interactive Services Repository (ISR) in the My Oracle Support website located at <https://support.oracle.com/CSP/ui/flash.html>.

Related Links

"Understanding the RTV Business Process" (PeopleSoft Purchasing)

Implementing an SRS Application Integration

This section discusses how to:

- Define par location data for the SRS application and the PeopleSoft system.
- Stock case carts from a surgical resource par location.
- Maintain item replenishment data in the SRS application and the PeopleSoft system.
- Restock a surgical resource par location.

Defining Par Location Data for the SRS Application and the PeopleSoft System

This section describes the procedures and application functions used to maintain par location data in PeopleSoft Inventory and the SRS application.

To maintain par location data in PeopleSoft and the SRS application:

1. Create surgical resource par locations in PeopleSoft Inventory.

Define the operating room resource locations as par locations in PeopleSoft Inventory using the Par Location Definition component. All item and par location data is set up and maintained in the PeopleSoft system.

2. Run the Full Data Publish process to initially populate the SRS application with item data.

Use the Full Data Publish process to publish a full-data replication of the par locations for the initial implementation using the PAR_LOCATION_FULL_SYNC service operation (EIP) in PeopleSoft Integration Broker. This process should be run once the par locations are defined. You use this service operation to initially populate the SRS application with par location item data.

3. Save changes to the Par Location Definition component to update the SRS application.

All subsequent changes saved to the Par Location Definition component for existing par locations are sent to the SRS application in partial-data replication EIP (PAR_LOCATION_SYNC service operation) using the Par Location Definition EIP. These partial-data replications are published when saving the Par Location Definition component to keep the SRS application current with ongoing PeopleSoft Inventory par location definition and item changes.

Related Links

[PeopleSoft SCM Inbound EIPs](#)

Stocking Case Carts From a Surgical Resource Par Location

This section describes the tasks performed to stock a case cart in an integration of a PeopleSoft system and a third-party SRS application.

To stock a case cart for a procedure:

1. Schedule the surgical procedure in the SRS application.

Typically, the operating room (OR) nurse or assistant schedules a procedure in the SRS application and defines a case cart of the required supplies for the procedure by using the preference cards defined for a physician or surgeon.

2. Run the material requisition process in the SRS application to source supplies required for upcoming procedures in PeopleSoft.

Several days before the procedure, a materials requisition process in the SRS application identifies all of the items needed for the procedure. For the required items with on-hand quantity below par, the SRS application publishes data containing the required quantities needed for the procedure.

PeopleSoft Purchasing subscribes to this data using the Purchase Order Requisition EIP. This service operation provides the PeopleSoft system with the information to enable the direct purchase of miscellaneous items needed for a particular procedure. This information includes the item ID, requested quantity, unit of measure, location (that is, the SRS storage location and PeopleSoft par location), due date (the procedure date), and case ID. The case ID is for trace purposes, and it is stored in the Description field (DESCR254) in the Comments table (PO_RQLD_CMT_SEG) in the EIP.

The data is inserted into the PeopleSoft Purchasing requisition staging tables (PO_REQLOAD_RQST and PO_REQLOAD_CMT). The Purchasing Requisition Loader process (PO_REQLOAD) picks up the staged requisitions and inserts those with no data errors into the PeopleSoft Purchasing requisition tables for sourcing.

If the Purchasing Requisition Loader process discovers errors in the data (such as data type inconsistency), the entire transaction is rejected. If there are application errors, the data is inserted and you can use the error-correction page to correct the data.

Requests for non-stock items that have been staged to the PeopleSoft system are designated as processed in the SRS application. If the material requisitioning process is run again before the procedure is performed, requisitions for items below par are not duplicated. However, if additional quantities of requested items are required or if new items are needed, a new requisition transaction is published and staged to PeopleSoft Purchasing.

If the original requisition quantity is decreased or canceled in the SRS application, the OR nurse or assistant can produce a cancellation report using the SRS application. This report identifying the canceled stock quantities can be sent to the materials management director, who can manually update the PeopleSoft system with the required changes. This might include canceling a requisition or modifying the requested quantity. If the supplier has already shipped the order or if the order has been received, it might require a return-to-vendor transaction.

To facilitate finding the purchase order associated with the procedure that was canceled, the case ID is passed on in the data exchanged in the Purchase Order Requisition EIP.

Based on SetID, supplier priority, and item attributes, PeopleSoft Purchasing sources the requested item using the PeopleSoft Purchasing distribution network, and it creates purchase orders for stockless items as well as material stock requests in PeopleSoft Inventory for stock items if the stock is available.

3. Receive and deliver the requested stock quantities to the surgical resource location.

Non-stock and stockless items are received using components in PeopleSoft Purchasing and delivered to the surgical resource location that generated the request for the item. Stock items are issued to the surgical resource par location from PeopleSoft Inventory.

4. At the surgical resource location, pick materials required for the case cart.

The day before the procedure, the OR nurse or assistant generates a pick list using the SRS application. The pick list is used at the surgical resource par location to retrieve the materials required to stock the case cart for the procedure.

Depending on internal rules and regulations, material that is not consumed from the case cart can be returned to the surgical resource par location, where it can be picked for another procedure.

For technical details about individual EIPs, use the Interactive Services Repository (ISR) in the My Oracle Support website located at <https://support.oracle.com/CSP/ui/flash.html>.

Related Links

[PeopleSoft SCM Inbound EIPs](#)

"Understanding Changing, Canceling, and Holding Orders" (PeopleSoft Inventory)

"Creating Online Orders Using Express Issue in PeopleSoft Inventory" (PeopleSoft Inventory)

Maintaining Item Replenishment Data in the SRS Application and the PeopleSoft System

Here's how to manage item replenishment data in the SRS application and the PeopleSoft system:

1. Use the SRS application to track material usage and on-hand quantity adjustments for the surgical resource par location.

After a procedure, the OR nurse or assistant records consumer material usage in the SRS application and adjusts par on-hand quantities for applicable surgical resource par locations.

2. Use the SRS application to publish on-hand par location count data to PeopleSoft Inventory using the Par Location Count EIP.

This publish occurs at user-requested intervals from the SRS application to provide the PeopleSoft system with current on-hand quantities for each item in the surgical resource par locations.

3. Use PeopleSoft Inventory to subscribe to the on-hand par location count data from the SRS application.

PeopleSoft Inventory subscribes to this data using the Par Location Count EIP. Once the data is received, the PeopleSoft system updates the par location count tables and the par location count information is ready to be processed using the Create Par Replenishment Requests process.

Note: Any existing SRS application-based replenishment processes are not used in this integration.

4. Run the Create Par Replenishment Requests process in PeopleSoft Inventory.

The Create Par Replenishment Requests process takes each par location count and replenishes those items that fall below the par level identified for the item on the Par Location Definition - Line page. A

purchase order, requisition, or material stock request is created in the PeopleSoft system to replenish the stock to par levels.

5. Deplete the material stock requests created to replenish a surgical resource par location.

For material stock requests that have issued stock from inventory to the par location and have been depleted, the Internal Location Expected Receipt EIP publishes a transaction to the SRS application by using the IN_PUB_MSG Application Engine process.

6. Receive direct-purchase items with the PeopleSoft Purchasing Receiving component.

Receiving material against a purchase order in the PeopleSoft Purchasing Receiving component triggers the publication of a transaction to the SRS application using the Purchase Order Receipt Notification EIP. This service operation identifies all direct-purchase items and quantities that have been received and are delivered to specified locations. The Receipt Push process (RECV_PUSH) loads the stage table (RECV_PUSH_NTIFY). If a chunking rule for the service operation and publish rule exists in the publish rule definition table (EO_MSGPUBDEFN), then the system creates staging records for only those par location receipt transactions that have the par location defined in the Par Location Chunking table (IN_BU_PAR_EOC). If a chunking rule does not exist, then staging records are created for all par location receipt transactions. Once the stage table is loaded, it calls the program that in turn publishes the receipt notification data.

For technical details about individual EIPs, use the Interactive Services Repository (ISR) in the My Oracle Support website located at <https://support.oracle.com/CSP/ui/flash.html>.

Related Links

"Replenishing Par Locations" (PeopleSoft Inventory)

[PeopleSoft SCM Inbound EIPs](#)

Restocking a Surgical Resource Par Location

This section describes the typical procedure used to physically restock a surgical resource par location.

To physically restock a surgical resource par location:

1. Generate the appropriate reports for the material being restocked at the surgical resource par location.

For item issues out of inventory, the IN Shipping Document (inventory shipping document) report (INC6503) can be requested to accompany the delivery of the stock items to the surgical resource par location. For purchased items, a Receiver Delivery report (POY5030) can be generated to accompany the stockless and non-stock items to the par location. This report, along with the service operation acknowledgment of the items sent, ensures that the par locations are updated with the correct quantities.

2. Compare expected receipts against actual receipts and record discrepancies.

When restocking a surgical resource location, verify that the quantity delivered to the location is the same as the quantity expected. If the actual quantity received is different from the expected quantity, record the variation on the report.

3. Manually restock the surgical resource par location's bin or compartment with the received stock.

Refill the bins or compartments in the surgical resource location with the received stock.

4. Complete the restocking event in the SRS application.

The final step of the restocking event takes place in the third-party SRS application. Typically, the person restocking the surgical resource par location updates the SRS application with the actual received quantities that are used to restock the bins or compartments in the surgical resource par location.

Using SRS Application EIPs

Five EIPs are used to exchange data between PeopleSoft Inventory and an SRS application. This section discusses the data flow and provides cross-references to information about the functional role and features of the following EIPs:

- Par Location EIP (outbound).
- Par Location Count EIP (inbound).
- Purchase Order Requisition EIP (inbound).
- Internal Location Expected Receipt EIP (outbound).
- Purchase Order Receipt Notification EIP (outbound).

Data Flow Between the PeopleSoft System and the SRS Application

The following diagram illustrates the data flow between an SRS application and PeopleSoft, including integration for par location counts, receipts, requisitions, and internal location expected receipts:

The following diagram illustrates the data flow between an SRS application and PeopleSoft.

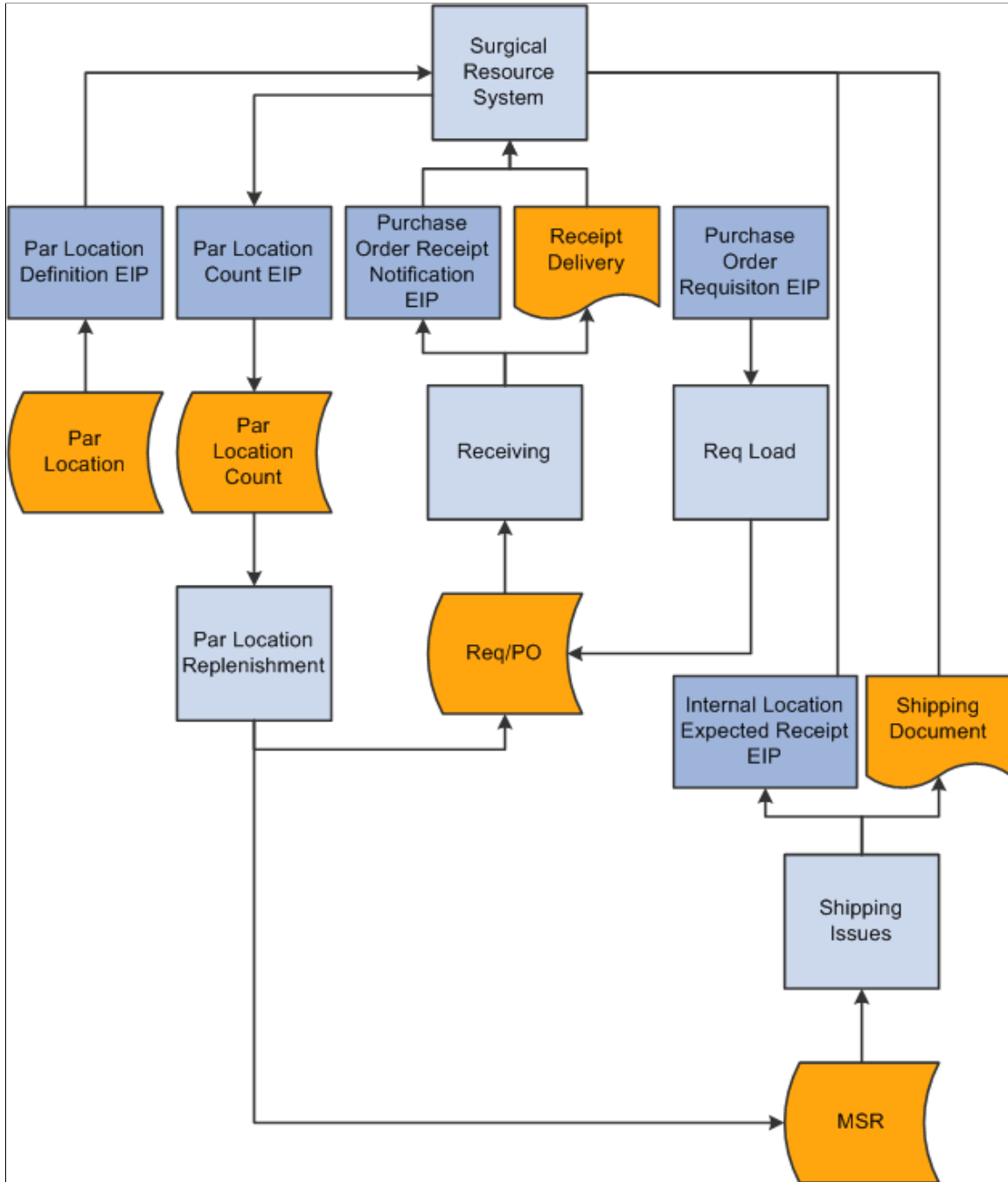

SRS Application EIPs

This table provides cross-references to information about the functional role and features of the SRS service operations in PeopleSoft Integration Broker.

<i>Enterprise Integration Point</i>	<i>Reference</i>
Par Location EIP (Outbound)	See Implementing an SRS Application Integration .

<i>Enterprise Integration Point</i>	<i>Reference</i>
Par Location Count EIP (Inbound)	See Implementing an SRS Application Integration .
Purchase Order Requisition EIP (Inbound)	See Implementing an SRS Application Integration .
Internal Location Expected Receipt EIP (Outbound)	See Implementing an SRS Application Integration .
Purchase Order Receipt Notification EIP (Outbound)	See Implementing an SRS Application Integration .

For technical details about individual EIPs, use the Interactive Services Repository (ISR) in the My Oracle Support website located at <https://support.oracle.com/CSP/ui/flash.html>.

Related Links

[PeopleSoft SCM Inbound EIPs](#)

Managing Errors for SRS EIPs

Error management is an integral part of the effectiveness of the PeopleSoft system of inbound EIPs. In the process of uploading data, the PeopleSoft subscription process detects any data errors and stores them in queues or staging tables for manual correction in the PeopleSoft system before updating any core PeopleSoft application tables.

Each inbound EIP that handles subscription of data from third-party applications has a respective transaction code that must be entered on an assigned data management page. The data management page allows access to the EIP's specific error correction page.

The Par Location Count EIP, which is used in both the SRS and point-of-use (POU) supplier system integrations, uses the transaction code *Par Loc*, which is entered on the Transaction Maintenance page. The Transaction Maintenance page is used to access error-correction pages for transactional data.

The Purchase Order Requisition EIP, which is used in the SRS integration, uses the transaction code *REQLOAD*, which is entered on the Data Definition Maintenance page. The Data Definition Maintenance page is used to access error-correction pages for definitional data.

Related Links

[PeopleSoft SCM Inbound EIPs](#)

Chapter 8

Designing an Electronic Data Collection System

Understanding Electronic Data Collection

Electronic data collection offers many advantages. It enables you to:

- Increase the accuracy of data entry.
- Decrease the amount of time spent on data entry.
- Improve productivity.
- Save cost.

PeopleSoft applications use electronic data collection for key material movement transactions and support for bar code printing on standard reports and labels. You can use the electronic data collection components to capture data from multiple sources, such as bar code devices, external feeds, and direct data entry.

Bar code-enabled material movement transactions are based on an open architecture so that you can select the data collection solution for use with PeopleSoft applications. With this architecture, third-party or in-house data collection hardware and software can feed transactions originating from data collection devices into the PeopleSoft system using a common, predefined interface.

Related Links

[Understanding Electronic Data Collection](#)

Setting Up Electronic Data Collection Defaults

To use an electronic data collection system with PeopleSoft applications, you must first set up system default information.

See [Data Collection Setup Page](#).

Setting Up Labels

To set up labels for data collection, use the Data Collection Label Setup (BCT_LABEL_FS_GBL) component. You must first select a label type to access the Data Collection Label Setup page. For example, you might select Container ID Label as the label type to identify containers at storage locations.

This section discusses how to set up data collection labels.

Page Used to Set Up Labels

<i>Page Name</i>	<i>Definition Name</i>	<i>Usage</i>
Data Collection Label Setup Page	BCT_LABEL_FS	At the SetID level, identify valid label formats that may be required when interfacing with a third-party label printing application.

Related Links

[Generating Labels](#)

Data Collection Label Setup Page

Use the Data Collection Label Setup page (BCT_LABEL_FS) to at the SetID level, identify valid label formats that may be required when interfacing with a third-party label printing application.

Navigation:

SCM Integrations > Barcode Labels > Setup Data Collection Labels > Data Collection Label Setup

<i>Field or Control</i>	<i>Description</i>
Format ID	<p>Enter an ID for a unique label design. A label type can have many format IDs. However, a format ID is not required. If the label printing application does not require a format ID, use this page to define the prefix and suffix for the file name of the label extract file.</p> <p>The format ID can be anything that you choose. If the label printing application does not require a format ID in the extract file, then the format ID is for your reference only. If the label printing application does require a format ID in the extract file, you would enter the format ID that the application uses and select the Include Format check box.</p> <p>The file name has an <i>xxxxyyyyzzzz</i> format, where <i>xxx</i> is the file prefix, <i>yyyyy</i> is the last five characters of the process instance ID, and <i>zzzz</i> is the file suffix. For example, if the file prefix is <i>GEN</i> and the suffix is <i>.LBL</i>, then the flat file generated by process instance 12345 would be named GEN12345.LBL.</p>
Default	Select to set a format ID as the default that appears on the Label Generation page. If you do not select a default format ID, the first format ID listed becomes the default.
File Prefix	Enter the prefix for the file name of flat files generated for printing labels. This is an optional field

Field or Control	Description
File Suffix	Enter the suffix for the file name of any flat files generated for printing labels. If you want a period as part of the suffix, you must include it in the field. This is an optional field.
Include Format	If this check box is selected, the format ID is inserted as the first field on every row in the label extract file.

Setting Up the UCC/EAN Manufacturer ID

To identify a manufacturer ID and starting container number, use the UCC/EAN Manufacturer component. You need to specify the manufacturer ID and starting container number for the label printing application in order to create a standard bar code accessible to all companies in the trading chain.

This section discusses how to specify the manufacturing ID.

Pages Used to Set Up the UCC/EAN Manufacturer ID

Page Name	Definition Name	Usage
<u>UCC/EAN Manufacturer ID Page</u>	BCT_MFGID_SETUP	Specify the manufacturer ID and starting container number.

UCC/EAN Manufacturer ID Page

Use the UCC/EAN Manufacturer ID page (BCT_MFGID_SETUP) to specify the manufacturer ID and starting container number.

Navigation:

SCM Integrations > Barcode Labels > Setup UCC and EAN Mfg ID > UCC/EAN Manufacturer ID

Field or Control	Description
Manufacturer ID	Enter an ID that is included in the extract file for the shipping container labels so that it can be formatted by the label printing software to create an industry-standard bar code label.
Shipping Container Serial ID	Enter an ID to uniquely identify the shipping container. Enter the starting container number, with up to nine digits, or leave it blank to start at 1. The shipping container serial ID is included in the extract file for the shipping container labels so that it can be formatted by the label printing software to create an industry-standard bar code label.

Setting Up the Wedge Command Code

To set up wedge command codes use the Set Up Wedge Command Code component.

See "Using Wedge Commands in Packing Sessions" (PeopleSoft Inventory).

Setting Up Unit of Measure

To associate items with units of measure use the Define Item component.

See "Using Units of Measure" (PeopleSoft Managing Items).

Setting Up Picking

To set up picking use the Setup Fulfillment component.

See "Defining Business Unit Fulfillment Options" (PeopleSoft Inventory).

Setting Up Putaway

To set up the Putaway Plan Report use the Putaway Plan Report component.

See "Generating the Putaway Plan Report" (PeopleSoft Inventory).

Chapter 9

Using an Electronic Data Collection System

Understanding Electronic Data Collection

Electronic data collection enables you to:

- Increase the accuracy of data entry.
- Decrease the amount of time spent on data entry.

You can use the electronic data collection components to capture data from:

- Bar code devices.
- External feeds.
- Direct data entry.

The following diagram shows the data flow for electronic data collection. Data from flat files or XML messages are placed in the inbound staging tables by the PeopleSoft Integration Broker system. Online or batch applications can also place data directly into the inbound staging tables. Background processes apply the data to the PeopleSoft production tables. Any errors are handles by the Transaction Maintenance component. The Purge process will delete all transactions with a status of *Complete* or *Confirmed* from the transaction log:

This image illustrates electronic data collection data flow.

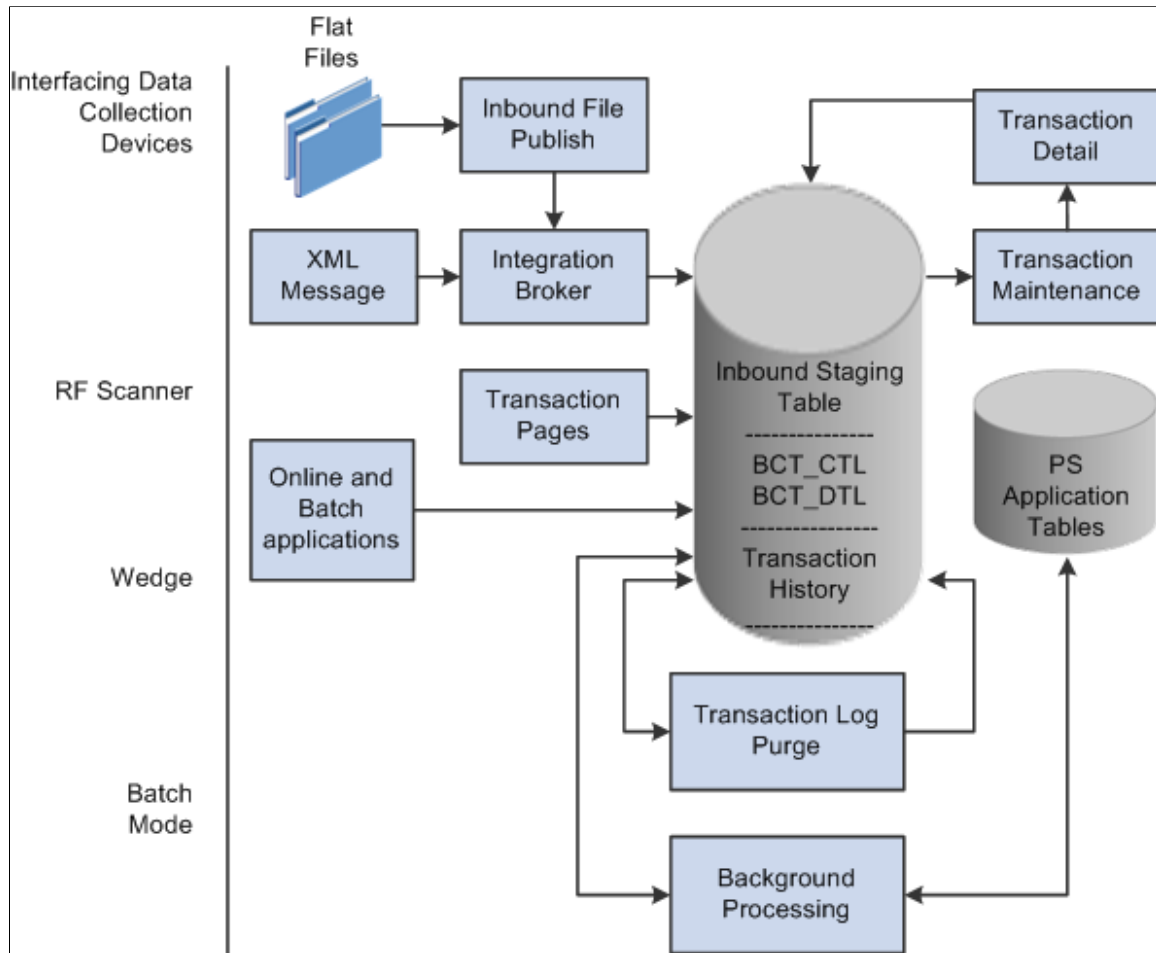

Related Links

[Transaction Maintenance Page](#)

[Purging Transactions](#)

Device Selection

The first step in designing an electronic data collection system is to select the data collection devices you will use to process bar code material movement transactions. PeopleSoft provides support for three bar code technologies:

Radio Frequency

Radio frequency (RF) systems are used when immediate access to the database is required. This technology requires RF terminals and controllers. RF data collection applications, developed in-house or by third-party suppliers, produce transactions that are passed to the PeopleSoft applications through PeopleSoft Integration Broker using XML messages.

Batch

Batch systems are used when real-time updates are not needed. Batch-oriented data collection applications, developed in-house or by a third-party supplier, produce transactions that are collected in an ASCII text file. The text file is loaded into the PeopleSoft system using the Inbound File Publish utility.

Keyboard Wedge

Keyboard wedges can be used when the person collecting the bar-coded information has access to a workstation running the PeopleSoft application. A wand or a laser gun connects to the keyboard wedge that inputs the bar-coded information directly into the transaction pages. The computer interprets information entered using the keyboard wedge in the same manner as information entered using the keyboard.

Related Links

[Processing Inbound EIPs](#)

Using Electronic Data Collection Transactions

Data collection transactions received through XML messages, batch oriented flat files, and the transaction pages are loaded into the transaction log. Background processes pick up these transactions, validate them, and then update the appropriate PeopleSoft application tables. If an error is found, the system does not process the transaction. The transaction's status on the transaction log is changed to *Error*, and the system inserts a row into the error table for each error message.

The BCt Errors Workflow process (IN_WFBCTERRS) checks for electronic data collection transactions that have an error status and generates a worklist entry. Once you process the worklist entry, the PeopleSoft system displays the Transaction Maintenance page, where you can view the errors and fix them.

Once you have modified the transaction and saved the Transaction Maintenance Detail page, the transaction can be reprocessed. Transactions that have been processed to the *Complete* status or that have been canceled in the Transaction Maintenance page can be archived and purged from the transaction log using the transaction purge process.

The background processes validate all information before performing any updates. However, when you enter the transactions through the data collection transaction pages, selected pieces of information on the page have edits to verify the data that is entered.

Transactions	Reference
Inventory Adjustments	See "Understanding Stock Quantity Adjustments and Transfers in a Business Unit" (PeopleSoft Inventory).
Interunit Receiving	See "Staging Interunit Transfers Using an Electronic Data Collection System" (PeopleSoft Inventory).

Transactions	Reference
Inventory Picking	See "Entering Picking Feedback Using an Electronic Data Collection System" (PeopleSoft Inventory).
Inventory Putaway	See "Entering Stockroom Feedback Using an Electronic Data Collection System" (PeopleSoft Inventory).
Inventory Transfer	See "Staging Interunit Transfers Using an Electronic Data Collection System" (PeopleSoft Inventory).
Ship Containers and Serial IDs	See "Working with Shipping Containers and Shipping Serial IDs Using an Electronic Data Collection System" (PeopleSoft Inventory).
Shipping Request	See "Understanding the Shipping Business Process" (PeopleSoft Inventory).
Production Picking	See "Processing Picking Plans Using Electronic Data Collection" (PeopleSoft Manufacturing).
Production Completions and Scrap	See "Processing Electronic Data Collection Completions Transactions" (PeopleSoft Manufacturing).
Production Multiple Outputs Completions and Scrap	See "Processing Electronic Data Collection Completions Transactions" (PeopleSoft Manufacturing).
Production Kit Issues and Returns	See "Processing Kit Issues and Returns Using Electronic Data Collection" (PeopleSoft Manufacturing).
Component Issues and Returns	See "Editing or Issuing Components" (PeopleSoft Manufacturing).
Actual Hours	See "Recording Actual Machine and Labor Hours" (PeopleSoft Manufacturing).
Purchasing Receiving	See "Receiving Items Using EDC" (PeopleSoft Purchasing).

For technical details about individual EIPs, use the Interactive Services Repository (ISR) in the My Oracle Support website located at <https://support.oracle.com/CSP/ui/flash.html>.

Using Background Transaction Processes

You set up electronic data collection background processes to scan the transaction log continuously as long as there are transactions in the log with the status *New* or *Reprocess*. If no transactions with the status *New* or *Reprocess* are in the log when a process scans the log, the process shuts down. If the process shuts

down, you can restart it with PeopleSoft Process Scheduler. Because you can set up Process Scheduler to automatically restart the background processes at predefined intervals, transaction processing can occur continuously or at set periods throughout the day.

Transaction	Page Name	Process Name	Tables Accessed	Tables Updated
Inventory Adjustments	BCT_INV_REQIADJ	INPVIADJ	BCT_INV_REQIADJ	BCT_INV_REQIADJ
Interunit Receiving	BCT_INV_REQIURV	INPJURV	BCT_INV_REQIURV	BCT_INV_REQIURV
Inventory Picking and Shipping	BCT_INV_REQPICK	IN_FUL_PFB	BCT_INV_REQPICK	BCT_INV_REQPICK
Inventory Putaway	BCT_NV_REQPWFB	INPZPTWY	BCT_NV_REQPWFB	BCT_NV_REQPWFB
Inventory Transfers	BCT_INV_REQTRFR	INPTTRFR	BCT_INV_REQTRFR	BCT_INV_REQTRFR
Physical Inventory	BCT_INV_REQPHYS	INPIPHYS	BCT_INV_REQPHYS	BCT_INV_REQPHYS
Ship Containers and Serial IDs	BCT_INV_REQSHPM	INPFSHPM	BCT_INV_REQSHPM	BCT_INV_REQSHPM
Shipping Request	BCT_INV_REQFUL	INV_FUL_BCT	RUN_CNTL_IN_FUL	RUN_CNTL_IN_FUL
Production Picking	BCT_MG_REQPIK	SFPEPICK	BCT_MG_REQPIK	BCT_MG_REQPIK
Kanban Replenishment Requests	BCT_MG_REQREPL	FPPAREPL	BCT_MG_REQREPL	BCT_MG_REQREPL
Production and Completions Scrap	BCT_MG_REQCOMP	SFPDCDRV	BCT_MG_REQCOMP	BCT_MG_REQCOMP
Kit Issues and Returns	BCT_MG_REQMISC	SFPFMISC	BCT_MG_REQMISC	BCT_MG_REQMISC
Actual Hours	BCT_MG_REQACT	SFPGACTH	BCT_MG_REQACT	BCT_MG_REQACT
Load Purchase Order Receipts	RUN_RECVLOAD	PO_RECVLOAD	RUN_CNTL_RECVLD	RUN_CNTL_RECVLD

Related Links

"Understanding Stock Quantity Adjustments and Transfers in a Business Unit" (PeopleSoft Inventory)

"Working with Shipping Containers and Shipping Serial IDs Using an Electronic Data Collection System" (PeopleSoft Inventory)

"Processing Picking Plans Using Electronic Data Collection" (PeopleSoft Manufacturing)

"Processing Electronic Data Collection Completions Transactions" (PeopleSoft Manufacturing)

"Processing Kit Issues and Returns" (PeopleSoft Manufacturing)

"Actual Hours process Page" (PeopleSoft Manufacturing)

Purging Transactions

You can periodically purge data collection transactions. The data collection architecture uses the standard purge process for PeopleSoft Supply Chain Management inbound transactions.

Related Links

[Purging Page](#)

Generating Labels

To generate bar code labels, you must first set up the attributes for each label type on the Label Setup page. Next, you generate a flat file containing the label data by running a PeopleSoft Process Scheduler Structured Query Report (SQR) program from the label-specific run control page. Use the Generate Labels component to create this flat file. Finally, you pass the flat file to an in-house or a third-party bar code label product to print the labels.

The PeopleSoft system can print 10 types of labels:

<i>Field or Control</i>	<i>Description</i>
Purchasing Receipt labels	Use these labels to track items that are received by the business unit. Receiving labels are generated for each item on a receipt. To print these labels, you must have PeopleSoft Purchasing installed.
Production Completion labels	Apply these labels to items that have been manufactured. To print these labels, you must have PeopleSoft Manufacturing installed.
Pull Ticket labels	Use these labels to track material replenished from online replenishment requests. To print these labels, you must have PeopleSoft Flow Production installed.
Kanban Card labels	Use these labels to track material replenished by Kanban Card. To print these labels, you must have PeopleSoft Flow Production installed.
Storage Location labels	Use these labels on storage locations, such as aisles, rows, and bins, in a business unit. To print these labels, you must have PeopleSoft Inventory installed.

Field or Control	Description
Item Storage labels	Use these labels to identify items in a carton or storage location. To print these labels, you must have PeopleSoft Inventory installed.
Storage Container labels	Use these labels to identify storage containers at a storage locations. To print these labels, you must have PeopleSoft Inventory installed.
Shipping Carton labels	Apply these labels to each carton before shipping to provide shipping information to shipping personnel and carriers. You can also use them to build shipping containers, and to provide customer-specific information that identifies items within the cartons. To print these labels, you must have PeopleSoft Inventory installed.
Shipping Serial labels	Use these labels to identify a serial ID assigned to items at the time the items are shipped. To print these labels, you must have PeopleSoft Inventory installed.
Shipping Container labels	Use these labels to identify shipping containers. Shipping container labels can be used to provide shipping information to shipping personnel, carriers, and customers. To print these labels, you must have PeopleSoft Inventory installed.
Item Usage labels	Use these labels to identify medical supplies used for patients. To print these labels, you must have PeopleSoft Inventory installed.

Related Links

[Setting Up Labels](#)

Managing Files

This section discusses how you work with files when generating labels.

Override File

To specify a file directory and file name for the extraction file, select the Override File check box, and enter the file directory and file name. Deselect the Override File check box to create the extraction file in the default directory with the default file name.

File Directory

Enter a directory path for the label file.

If you do not select the Override File check box, on any label except the Carton Label, the directory is selected according to the following hierarchy:

1. The directory name is the FILEPREFIX that was specified in SETENV.SQC during the initial system setup.

For information on setting the FILEPREFIX in the SETENV.SQC, refer to the *PeopleTools Installation and Administration* for the platform.

2. If no FILEPREFIX was specified during system setup, the directory name is by default the current work directory on the server running the label program.

File Name

Enter a file name for the label file.

If you do not select the Override File check box, on any label except the carton label, the file is named according to the following hierarchy:

1. The file name is the file prefix that is defined for the format ID (on the Data Collection Label Setup page in the Generate Labels window) combined with the last five digits of the process ID; the file name suffix is the file suffix defined for the format ID.
2. If no format ID is specified on the Data Collection Label Setup page, the last five digits of the process ID are used as the file name, and the file name suffix is the file suffix defined on the Data Collection Setup page in Process Transactions.
3. If no file suffix is defined on the Data Collection Setup page, the last five digits of the process ID are used as the file name, and the file name suffix is the FILESUFFIX that you specified in SETENV.SQC when you initially set up the system.

For information on setting the FILESUFFIX in the SETENV.SQC, refer to the installation documentation.

4. If no file suffix was specified in SETENV.SQC when you initially set up the system, the last five digits of the process ID are used as the file name, and no suffix is appended.

The following table indicates the sequence of defaults that the system uses when assigning file names:

File Prefix	File Name	File Suffix
Override	Override	Override
From format ID specified on the Data Collection Label Setup page.	The last five digits of the process ID. If multiple requests can be entered on the label request page, then an additional two-digit sequential number starting with 01 is appended to the end of the file name.	From format ID specified on the Data Collection Label Setup page.

File Prefix	File Name	File Suffix
None	The last five digits of the process ID. If multiple requests can be entered on the label request page, then an additional two-digit sequential number starting with 01 is appended to the end of the file name.	The file suffix defined on the Data Collection Setup page.
None	The last five digits of the process ID. If multiple requests can be entered on the label request page, then an additional two-digit sequential number starting with 01 is appended to the end of the file name.	The FILESUFFIX that you specified in SETENV.SQC.
None	The last five digits of the process ID. If multiple requests can be entered on the label request page, then an additional two-digit sequential number starting with 01 is appended to the end of the file name.	None.

Pages Used to Print Labels

Page Name	Definition Name	Usage
<u>Purchasing Receipt Labels Page</u>	RUN_PO_RECEIPT	If you have PeopleSoft Purchasing installed, select the process request parameters for purchasing receipt labels. Purchasing receipt labels are used to track items that are received by the business unit. Receiving labels can be generated for each item on a receipt.
Completion Label - Production Select Page	RUN_SFS7004	Select the business unit for which to print labels. You can also indicate whether printed labels are based on a production ID or production schedule.
<u>Completion Label - Completion Labels Page</u>	RUN_SFS7004B	Select the number of labels to print.
<u>Pull Ticket/Pull List Options Page</u>	RUN_FPS6500	Indicate how you want to print pull tickets and pull lists.
Pull Ticket/Pull List Range Page	RUN_FPS6500A	Make the printing selection.

Page Name	Definition Name	Usage
Printing Kanban Card Page	RUN_FPS6510	Print Kanban Card labels.
Kanban Card Range Page	RUN_FPS6510A	Select the kanban card label range.
Storage Location Label Page	RUN_INS9025	Select the process request parameters for printing bar code labels for storage locations.
Item Storage Label Page	RUN_INS9010	Select the process request parameters for printing bar code labels for items in storage.
Storage Container Label Page	RUN_INS9015	Select the process request parameters for printing container labels for storage container IDs.
Shipping Carton Label Page	RUN_INS6025	Select the process request parameters for shipping carton labels. The shipping carton labels can be automatically printed during picking.
Shipping Serial Label Page	RUN_INS6035	Select the process request parameters for shipping serial labels. If you assign a shipping serial label ID at shipping time, you can track items after they have been shipped.
Printing Shipping Container Label	RUN_INS6030	Select the process request parameters for shipping container labels.
Item Usage Label Page	RUN_INS6040	Select the process request parameters for item usage labels.

Related Links

[Setting Up Labels](#)

[Shipping Carton Label Page](#)

Common Elements Used in This Section

Field or Control	Description
Language	Select a language for the legible portion of the labels.
Business Unit or Unit	Select the unit for which to print labels.

Field or Control	Description
Format ID	Enter a label format ID. Label formats are defined on the Data Collection Label Setup page. If you set up a default label format, its ID appears in this field.
Copies	Enter the number of copies of each label to print. When printing serial or sequential labels, if you increase the number in this field, the system multiplies the number of labels that you print. For example, if you are printing six labels in a sequence, and the number of copies is 1, then six labels print. However, if the number of copies is 2, then two copies of each label print, for a total of 12 labels.

Purchasing Receipt Labels Page

Use the Purchasing Receipt Labels page (RUN_PO_RECEIPT) to if you have PeopleSoft Purchasing installed, select the process request parameters for purchasing receipt labels.

Purchasing receipt labels are used to track items that are received by the business unit. Receiving labels can be generated for each item on a receipt.

Navigation:

- **SCM Integrations > Barcode Labels > PO Receipt Label > PO Receipt Labels**
- **Purchasing > Receipts > Reports > Receipt Labels > PO Receipt Labels**
- **Purchasing > Receipts > Process Receipts**

To print all receiving labels staged by the user ID:

1. Select the **Reprint Labels** check box to reprint receiving labels.

The Business Unit, Receiver ID Number and Receiver Line Number fields will become available for entry if the Reprint Labels check box is selected.

2. Select the receiver ID number for which you want to reprint labels.
3. Enter the receiver line number for the item and quantity for which you want to reprint labels.

Process Type

SQR Report

Tables Accessed

BCT_LABEL_FS

BCT_SETUP_FS

RECV_RUN_CNTL

RECV_LABEL_TBL

SET_CNTRL_REC

SET_CNTRL_TREE

RECV_LN

RECV_LN_ASSET

BU_ITEMS_INV

Tables Updated

RECV_LABEL_TBL

Completion Label - Completion Labels Page

Use the Completion Label - Completion Labels page (RUN_SFS7004B) to select the number of labels to print.

Navigation:

SCM Integrations > Barcode Labels > Create Label for Items

To print completion labels by production ID or by production schedule:

1. To print completion labels by production ID, enter the production ID.
2. To print completions labels by production schedule, enter the production area and item ID.

If the item is revision controlled, select a revision code if the revision is required on the labels.

3. Once the process request parameters are entered, click the **Search** button to access the Completion Labels page.

Note: If the conversion rate between the standard unit of measure (UOM) and the standard pack UOM is not set up for this item, the page produces an error message, and the system does not display the Completion Labels page.

Tables Accessed

MASTER_ITEM_TBL

INV_ITEMS

BCT_LABEL_FS

BCT_SETUP_FS

RUN_CNTL_SF

Tables Updated

RUN_CNTL_SF

Pull Ticket/Pull List Options Page

Use the Pull Ticket/Pull List Options page (RUN_FPS6500) to indicate how you want to print pull tickets and pull lists.

Navigation:

- **Manufacturing Definitions > Kanban > Electronic Kanbans > Print Pull Ticket/Pull List > Pull Ticket/Pull List Options**
- **SCM Integrations > Barcode Labels > Pull Ticket Label > Pull Ticket/Pull List Options**

This example illustrates the fields and controls on the Pull Ticket/Pull List Options page. You can find definitions for the fields and controls later on this page.

Pull Ticket/Pull List Options		Pull Ticket/Pull List Range	
Run Control ID	Ticket	Report Manager	Process Monitor
Language	English	<input type="button" value="Run"/>	
Business Unit	US001		
Repl Method	WIP Replenishment Output Opt		
<input type="radio"/> Pull List <input type="radio"/> Pull Ticket <input checked="" type="radio"/> Both	<input type="checkbox"/> Create File for Pull Tickets <input type="checkbox"/> Print Bar Code <input type="checkbox"/> Print Bar Coded Control Flags		
	Format ID <input type="text"/>		
	File Directory <input type="text"/>		
	File Name <input type="text"/>		
Request Print Status Option	Sort Option	WIP Replenishment Source Opt	
<input checked="" type="radio"/> Not Printed <input type="radio"/> Previously Printed <input type="radio"/> Both Printed and Unprinted	<input type="radio"/> Kanban ID <input type="checkbox"/> Break <input checked="" type="radio"/> Item ID <input type="radio"/> WIP Location <input type="radio"/> Repl Source	<input type="radio"/> Inventory Location <input type="radio"/> Feeder Line (Prdn Area) <input checked="" type="radio"/> Both	

Field or Control	Description
WIP Replenishment Output Opt	<p>Choose one of the three options for the WIP Replenishment Output Options.</p> <ul style="list-style-type: none"> • Select Create File for Pull Tickets to create an extract file. You can use this file to download pull ticket information to label generation software. • Select Print Bar Code to print bar codes for bar coded fields on the pull ticket. • Select Print Bar Coded Control Flags to attach an item's control flags to the bar code printed on each line of the pull ticket. These control flags enable the electronic data collection system to prompt for the lot ID, serial ID, staged date, or shipping serial ID immediately after the user scans the bar-coded line number field. For cases that do not require control flags, you might prefer not to select this check box. The format for the bar code printed for each detail line is LSDAH:99999, where: <ul style="list-style-type: none"> • L = Lot ID Control Flag • S = Serial ID Control Flag • D = Staged Date Control Flag • A = Actual Cost Control Flag • H = Shipping Serial ID Control Flag • : = Constant • 99999 = Line Number <hr/> <p>Note: PeopleSoft delivers printer settings for all SQR output to a generic line printer. However, when printing bar coded information on reports on a PCL printer (HP Laser Jet), you must first define the printer type accordingly. You may do this by changing the printer type settings delivered in SETENV. SQC from LINEPRINTER to HPLASERJET.</p>
Format ID	Select a Format ID for the extract file. You set up format IDs on the Data Collection Label Setup page.
File Directory and File Name	Enter the File Directory and File Name to which you want to save the pull ticket file extract.
Request Print Status Option	Select a Request Print Status Option: Not Printed, Previously Printed, or Both Printed and Unprinted.

Printing Kanban Card Page

Use the Print Kanban Card page (RUN_FPS6510) to print Kanban Card labels.

Navigation:

- **SCM Integrations > Barcode Labels > Print Kanban Card Label > Print Kanban Cards**
- **Manufacturing Definitions > Kanban > Kanban Cards > Print Kanban Cards**

This example illustrates the fields and controls on the Print Kanban Cards page. You can find definitions for the fields and controls later on this page.

Print Kanban Cards
Kanban Card Range

Run Control ID **CARD**

Language **English** ▼

Business Unit **US001** 🔍

Report Manager

Process Monitor

Run

WIP Repl Kanban Card Output

Create File for Kanban Cards

Print Bar Code

Print Bar Coded Control Flags

Format ID

File Directory

File Name

Request Print Status Option

Not Printed

Previously Printed

Both Printed and Unprinted

Sort Option

Kanban ID

Item ID

WIP Location

Repl Source

WIP Replenishment Source Opt

Inventory Location

Feeder Line (Prdn Area)

Supplier

Field or Control	Description
WIP Repl Kanban Card Output	<p>Choose one of the three options for the WIP Replenishment Kanban Card Output options.</p> <ul style="list-style-type: none"> • Select Create File for Kanban Card to create an extract file. You can use this file to download Kanban card information to label generation software. • Select Print Bar Code to print bar codes for bar coded fields on the Kanban card. • Select Print Bar Coded Control Flags to attach an item's control flags to the bar code printed on each line of the Kanban card. Flow Production uses serial control and lot control flags. These control flags enable the electronic data collection system to prompt for the lot ID, serial ID, staged date, or shipping serial ID immediately after the user scans the bar-coded line number field. For cases that do not require control flags, you might prefer not to select this check box. The format for the bar code printed for each detail line is LSDAH:99999, where: <ul style="list-style-type: none"> • L = Lot ID Control Flag • S = Serial ID Control Flag • D = Staged Date Control Flag • A = Actual Cost Control Flag • H = Shipping Serial ID Control Flag • : = Constant • 99999 = Line Number <hr/> <p>Note: PeopleSoft delivers printer settings for all SQR output to a generic line printer. However, when printing bar coded information on reports on a PCL printer (HP Laser Jet), you must first define the printer type accordingly. You may do this by changing the printer type settings delivered in SETENV. SQR from LINEPRINTER to HPLASERJET.</p>
Format ID	Select a Format ID for the extract file. You set up format IDs on the Data Collection Label Setup page.
File Directory and File Name	Enter the File Directory and File Name to which you want to save the Kanban card file extract.
Request Print Status Option	Select a Request Print Status Option: Not Printed, Previously Printed, or Both Printed and Unprinted.

If you print Kanban cards that haven't been previously printed, the system changes the Kanban ID status to Open from New. Cards that were previously printed display Reprint on the card.

Kanban Card Range Page

Use the Kanban Card Range page (RUN_FPS6510A) to select the kanban card label range.

Navigation:

- **SCM Integrations > Barcode Labels > Kanban Card Label > Kanban Card Range**
- **Manufacturing Definitions > Kanban > Kanban Cards > Print Kanban Cards > Kanban Card Range**

Storage Location Label Page

Use the Storage Location Label page (RUN_INS9025) to select the process request parameters for printing bar code labels for storage locations.

Navigation:

SCM Integrations > Barcode Labels > Storage Location Label

To print storage location labels:

1. Select the storage areas for which you want to print labels in the storage area fields.
If you select only the first level, the system prints labels for all the storage locations in that area down to the lowest level.
2. If you want to print labels for all the locations in your warehouse, then you would enter the area fields only to the warehouse level.
3. If you want to print labels for all the bins in an aisle, then you would enter the storage area fields down to the aisle level.

Tables Accessed

BCT_LABEL_FS

BCT_SETUP_FS

STOR_LOC_INV

Tables Updated

RUN_CNTL_IN

Item Storage Label Page

Use the Item Storage Label page (RUN_INS9010) to select the process request parameters for printing bar code labels for items in storage.

Navigation:

SCM Integrations > Barcode Labels > Item Storage Label

To print item storage labels:

1. Select the **Autogenerate Labels** check box to have the system automatically generate all the item labels that you need for a storage location.
2. The **Stor Loc** (storage location) fields are required only if you use the **Autogenerate Labels** option.
Use these fields if you want to print labels for all the items in a specific storage location.
3. If you select **Autogenerate Labels** and enter a storage area, you can enter the unit of measure by which you want to print the labels in the **Group UOM** (group unit of measure) field.

For example, Location B01 has a quantity of *100 EA* (each). You select group UOM of *CS* (case). If there are 25 each per case, then the system generates four labels. If you select a group UOM of *EA* (each), then the system generates 100 labels.
4. If you select a serial-controlled item, the **Group UOM** field automatically appears with the standard unit of measure for the item and is unavailable for entry.

One label per serial ID is printed.
5. If you enter a storage area for a lot-controlled, serial-controlled, staged date tracked, or actual costed item, the system verifies that the item exists in the specified storage area.

Tables Accessed

BCT_LABEL_FS

BCT_SETUP_FS

BU_ITEMS_INV

INV_ITEMS

INV_STCK_UOM_VW

MASTER_ITEM_TBL

PO_RECEIVED_INV

Tables Updated

RUN_CNTL_IN

Storage Container Label Page

Use the Storage Container Label page (RUN_INS9015) to select the process request parameters for printing container labels for storage container IDs.

Navigation:

SCM Integrations > Barcode Labels > Storage Container Label

To print storage container labels:

1. Select a storage container prefix in the **Beg Seq** (beginning sequence) field.

The storage container prefixes are defined on the Automatic Numbering page.

2. Enter the number of labels that you want to print in the **Nbr in Seq** (number in sequence) field.

The next sequence of labels for the storage container prefix that you entered are printed. The last sequence number used for the storage container prefix that you entered is saved in the system.

Tables Accessed

BCT_LABEL_FS

BCT_SETUP_FS

AUTO_NUM_TBL

Tables Updated

AUTO_NUM_TBL

RUN_CNTL_IN

Shipping Carton Label Page

Use the Shipping Carton Label page (RUN_INS6025) to select the process request parameters for shipping carton labels.

The shipping carton labels can be automatically printed during picking.

Navigation:

SCM Integrations > Barcode Labels > Shipping Carton Label

This example illustrates the fields and controls on the Shipping Carton Label page. You can find definitions for the fields and controls later on this page.

The screenshot shows the 'Shipping Carton Label' page with the following elements:

- Run Control ID:** Carton
- Report Manager:** Report Manager
- Process Monitor:** Process Monitor
- Run:** A yellow button.
- Language:** English (dropdown menu)
- Process Request Parameters:** A section with search and navigation options (Find, View All, First, 1 of 1, Last).
- *Request ID:** Input field with a search icon.
- Unit:** Input field with 'US001' and a search icon.
- Pick Batch ID:** Input field with a search icon.
- Pick Line:** Input field with a search icon.
- Source:** Input field.
- Source Unit:** Input field.
- Order:** Input field.
- Line:** Input field.
- Printing Selection:** A dropdown menu with options:
 - Pick Batch ID
 - Order Number
- Format ID:** A section containing:
 - Format ID:** Input field with a search icon.
 - Copies:** Input field with '1'.
 - Unit of Measure:** A dropdown menu with options:
 - Order
 - Standard
 - Standard Pack
- Override File:** A section containing:
 - Override File
 - File Directory:** Input field.
 - File Name:** Input field.

If the format ID is not entered, it automatically appears first from the ship to location, then from the sold to location, or then from the Label Setup page, in that order, depending on which of these values exist.

To specify a file directory and file name for the label extraction file, select the **Override File** check box, and enter the file directory and file name. Deselect the **Override File** check box to create the extraction file in the default directory with the default file name.

To select the directory for the carton label file, use the following hierarchy:

1. The path you specify for the file directory takes precedence.
2. If you do not specify a file directory, the directory automatically appears the Pick Plan Bar Coding Options page in the Setup Fulfillment component (ORDER_FULF_SETUP).
3. If no directory is specified on the Pick Plan Bar Coding Options page in the Setup Fulfillment component, the directory name is the FILEPREFIX that was specified in SETENV.SQC during the initial system setup.

For information on setting the FILEPREFIX in the SETENV.SQC, refer to the installation documentation.

4. If no FILEPREFIX was specified during system setup, the directory name defaults to the current directory where the label program is running.

To name the file for the carton label file, use the following hierarchy:

1. The file name specified in the **File Name** field takes precedence.
2. If you don't specify a file name, the file name is the file prefix defined on the Pick Plan Bar Coding Options page in the Setup Fulfillment component combined with the last five digits of the process ID and the file suffix defined on the Pick Plan Bar Coding Options page.

3. If nothing is specified on the Pick Plan Bar Coding Options page, the last five digits of the process ID are used as the file name and the file name suffix is the FILESUFFIX that you specified in SETENV.SQC when you initially set up the system.

For information on setting the FILESUFFIX in the SETENV.SQC, refer to the installation documentation.

4. If no FILESUFFIX was specified in SETENV.SQC when you initially set up the system, the last five digits of the process ID are used as the file name and no suffix is appended.

File Prefix	File Name	File Suffix
Override	Override	Override
The file prefix defined on the Pick Plan Bar Coding Options page in the Setup Fulfillment component.	The last five digits of the process ID. If multiple requests can be entered on the label request page, then an additional two-digit sequential number starting with 01 is appended to the end of the file name.	The file suffix defined on the Pick Plan Bar Coding Options page in the Setup Fulfillment component.
None	The last five digits of the process ID. If multiple requests can be entered on the label request page, then an additional two-digit sequential number starting with 01 is appended to the end of the file name.	The FILESUFFIX that you specified in SETENV.SQC.
None	The last five digits of the process ID. If multiple requests can be entered on the label request page, then an additional two-digit sequential number starting with 01 is appended to the end of the file name.	None.

Tables Accessed

BCT_LABEL_FS

BCT_SETUP_FS

BU_ITEMS_INV

CARRIER_ID

CUST_ADDRESS

CUST_SHIPTO_OPT

CUST_SOLDTO_OPT

IN_DEMAND

DF_SETUP_INV

DF_SETUP_IT_INV
INV_ITEM_UOM
INV_ITEMS
ISSUE_HDR_INV
LOCATION_TBL
MASTER_ITEM_TBL
ORD_LINE

Tables Updated

RUN_CNTL_IN

Shipping Serial Label Page

Use the Shipping Serial Label page (RUN_INS6035) to select the process request parameters for shipping serial labels.

If you assign a shipping serial label ID at shipping time, you can track items after they have been shipped.

Navigation:

SCM Integrations > Barcode Labels > Print Serial Number Label

Tables Accessed

AUTO_SERIAL_NUM
BCT_LABEL_FS
BCT_SETUP_FS

Tables Updated

AUTO_SERIAL_NUM
RUN_CNTL_IN

Printing Shipping Container Label

The UCC/EAN manufacturer ID is included in the extract file for the shipping container labels. The UCC/EAN manufacturer ID along with the shipping container serial ID provide a unique identifier to create a unique shipping ID for the shipping container.

Note: You cannot print shipping container labels for more than one location at a time. If the criteria that you specify include multiple ship to locations, a warning message appears requesting that you narrow the criteria until only one ship to location is included.

Tables Accessed

BCT_LABEL_FS

BCT_MFGID_SETUP

BCT_SETUP_FS

CARRIER_ID

CUST_ADDRESS

CUST_SHIPTO_OPT

CUST_SOLDTO_OPT

IN_DEMAND

ISSUE_HDR_INV

LOCATION_TBL

ORD_LINE

Tables Updated

BCT_MFGID_SETUP

IN_DEMAND

RUN_CNTL_IN

Related Links[Setting Up the UCC/EAN Manufacturer ID](#)["Understanding Shipping Containers and Packing Sessions" \(PeopleSoft Inventory\)](#)

Understanding Record Layouts for the Electronic Data Collection System

Par Location Count and Physical Accounting File Formats

PeopleSoft Inventory provides two transactions that can be processed using batch flat files that are downloaded and uploaded using SQR programs.

The system uses batch processes to generate a flat file containing the item to be counted for either of the transactions. The flat file is passed to a third-party electronic data collection system that performs the count. The flat file must then be returned to PeopleSoft in the same format.

The files that you download to and upload from electronic data collection devices must conform to these rules:

- The file name must be eight characters or less.

An extension of .upl is automatically appended to upload file names. An extension of .dwn is automatically appended to download file names.

- The first field must start in column one.
- There must be a single blank space between each field.
- All fields must be left-justified.
- The system expects the file that is read by the upload process to have a .upl extension.

Par Location Count

You can download par location count information for use in a hand-held bar code device. You can select the following options to download:

- One par location at a time.
- All par locations for a par location group.
- All par locations for a specified business unit.
- All par locations.

Below is the layout of the par location download and upload file.

The download process creates a .dwn file of 404 characters per record from the par location definition tables (CART_ATTRIB_INV and CART_TEMPL_INV). The upload expects the same file layout, 404 characters per record as a .upl file. The upload process updates the par location count tables

(CART_CT_INF_INV). Each par location is created with an unprocessed status, and you can view them on the Par Location Count Inquiry page.

Contents	Format
BUSINESS_UNIT	5
INV_CART_ID	15
CART_GROUP	5
CART_REPLEN_OPT *	2
SHADOW_FLAG *	1
QTY_OPTION *	2
INV_ITEM_ID	18
DESCR	30
COMPARTMENT	10
COUNT_ORDER	4
COUNT_REQUIRED *	1
SUFFICIENT_STOCK *	1
CART_REPLEN_CTRL *	2
CART_COUNT_QTY *	16
DEFAULT_QTY	16
QTY_OPTIMAL	16
FOQ (Fixed Order Qty)	16
QTY_MAXIMUM	16
UNIT_OF_MEASURE	3

Contents	Format
DISTRIB_TYPE	10
DEPTID	10
TRANSFER_COST	15
PRICE_MARKUP_PCT	15
CHARGE_CODE	20
ACCOUNT	10
ALTACCT	10
OPERATING_UNIT	8
PRODUCT	6
PROJECT_ID	15
CONS_NON_STOCK	1
BCKORDR_CNCL_FLAG	1
CHANGE_MARKUP_AMT	16
CHANGE_MARKUP_PCNT	15
MATERIAL_RECON_FLG	1
USG_TRCKNG_METHOD	2
LAST_OPRID	8
LAST_DTTM_UPDATE	26

Field-Specific Notes

See the field-specific information that follows.

CART_REPLEN_OPT

Specifies the way in which an item is to be replenished.

01 [Symbol_Wingdings_224] "stk" or "stock" (creates an MSR).

02 [Symbol_Wingdings_224] "less" or "stockless" (creates a staged purchase order).

03 [Symbol_Wingdings_224] "nons" or "non-stock" (creates a requisition).

04 [Symbol_Wingdings_224] "not replenished" (item is not to be replenished).

Note: The system uses stockless and non-stock replenishment options only if PeopleSoft Purchasing is installed.

SHADOW_FLAG

The shadow par location flag, which has an online label of *not replenished*, appears on the hand-held bar code device. This informs the user that this par location is not to be replenished.

QTY_OPTION

A hand-held bar code device can modify this field.

The quantity options for each par location count appears by default based on the default quantity option that you defined on the Par Location Group Definition page.

If the default quantity option is count, the system prompts the user to enter the quantity on hand on the par location. If the default quantity is request, the system prompts the user to enter the requested quantity.

Values are:

01 [Symbol_Wingdings_224] "c" or "count qty."

02 [Symbol_Wingdings_224] "r" or "request qty."

COUNT_REQUIRED

The COUNT_REQUIRED flag is evaluated to determine whether a count must be entered for an item. This flag is defined per item on the Par Location Group Definition page.

SUFFICIENT_STOCK

A hand-held bar code device can modify this field.

The SUFFICIENT_STOCK flag is available for entry on the hand-held bar code device if the quantity option is *count qty*. PeopleSoft provides this field, so that the user does not need to enter a count for that item if it is not necessary.

CART_REPLEN_CTRL

Identifies how the order quantity is to be calculated if the quantity option is set to count quantity.

01 [Symbol_Wingdings_224] "Par"

02 [Symbol_Wingdings_224] "FOQ" or "Fixed Order Qty"

03 [Symbol_Wingdings_224] "Min/Max"

CART_COUNT_QTY

A hand-held bar code device can modify this field.

The quantity options for each par location count appears by default based on the default quantity option that you defined on the Par Location Group Definition page.

If the default quantity option is count, the system prompts the user to enter the quantity on hand on the par location. If the default quantity is request, the system prompts the user to enter the requested quantity.

Related Links

"Understanding Par Location Management" (PeopleSoft Inventory)

Physical Accounting

You can use a hand-held bar code device to conduct your physical counting event. To ensure data transfer accuracy, first configure the download and upload file formats for the counting sheet according to the layout presented in the next table. All fields must be left-justified, with a space between each field.

Field	Comments	Format
INV_ITEM_ID	Required.	Char 18
STORAGE_AREA	Required.	Char 5
STOR_LEVEL_1	Required, if set up for the storage area.	Char 4
STOR_LEVEL_2	Required, if set up for the storage area.	Char 4
STOR_LEVEL_3	Required, if set up for the storage area.	Char 4
STOR_LEVEL_4	Required, if set up for the storage area.	Char 4
UNIT_OF_MEASURE	Required. Must contain the stocking unit of measure (UOM) at the location.	Char 3
STAGED_DATE	Required. If the item is staged-date controlled, this field must contain the appropriate staged date. If the item is not staged-date controlled, include the filler default value that you established on the Installation Options - Inventory page in the Installation Options component.	MMDDYYYY

Field	Comments	Format
SERIAL_ID	Required. If the item is serial-controlled, this field must contain the appropriate serial ID. If the item is not serial-controlled, include the filler default value that you established on the Installation Options - Inventory page in the Installation Options component.	Char 20
INV_LOT_ID	Required. If the item is lot-controlled, this field must contain the appropriate lot ID. If the item is not lot-controlled, include the filler default value that you established on the Installation Options - Inventory page in the Installation Options component.	Char 15
CONTAINER_ID	Optional.	Char 10
QTY	Required. Must contain a quantity; zero is valid.	Nbr 16
UNIT_OF_MEASURE_COUNT	Required. Must contain a valid UOM for the item. If this UOM is different than the stocking UOM noted above, then the quantity is converted to the stocking UOM before updating the database.	Char 3
ITEM_DESCR	Optional. For informational purposes only.	Char 30
COUNT_DTTM	Must contain a date. If the field is blank then the system does not update the row.	MM/DD/YYYY HH:MI:SS

Related Links

"Understanding Counts" (PeopleSoft Inventory)

Label Extract File Record Definitions

The label extract file record definitions define the format for each label extract file. The label extract file is the output that the PeopleSoft application sends to the label printing software that you use to print the bar-coded labels.

The label extract files contain many field values that you can use in your label print process.

The label extract files are in comma-delimited format.

Each label extract file that contains an item ID also includes control flags that identify characteristics of that item. The control flags can be concatenated to various key fields that are printed as bar codes. For example, suppose that you concatenate the control flags to the item ID on the item storage labels, your electronic data collection system knows what other keys for which to prompt.

Here are the five control flags:

Field or Control	Description
Lot Control Flag	Set to <i>Y</i> if the item is lot-controlled. Set to <i>N</i> if the item is not lot-controlled.
Serial Control Flag	Set to <i>Y</i> if the item is serial-controlled. Set to <i>N</i> if the item is not serial-controlled.
Staged Date Control Flag	Set to <i>Y</i> if the item is staged-date controlled. Set to <i>N</i> if the item is not staged-date controlled.
Actual Cost Control Flag	Set to <i>Y</i> if the item is actual-costed. Set to <i>N</i> if the item is not actual-costed.
Shipping Serial Control Flag	Set to <i>Y</i> if the item is shipping serial-controlled. Set to <i>N</i> if the item is not shipping serial-controlled. The shipping serial control flag is only included on the shipping carton and shipping container transactions.

Note: The **Format ID** is an optional field on all of the label extract file records. It is in the first position only if the **Include Format** check box is selected for the specified format ID.

Related Links

[Data Collection Setup Page](#)

Item Usage Label

The label extract file record definitions define the format for the label extract file.

Storage Location Label Field Name	Format
Label Format ID	Char 30
Business Unit	Char 10
Location Code/Par Location Code	Char 15
Location Description/Par Location Description	Char 30

Storage Location Label Field Name	Format
Item ID	Char 40
Item Description	Char 30
Quantity	Nbr 11.4
Unit of Measure	Char 3
Standard Unit of Measure	Char 3

Item Storage Label

The label extract file record definitions define the format for the label extract file.

Item Storage Label Field Name	Format	Desc./Com.
Label Format ID	Char 30	N/A
Business Unit	Char 10	N/A
Item ID	Char 40	N/A
Item Description	Char 30	N/A
Lot Control Flag	Char 1	N/A
Lot ID	Char 15	N/A
Serial Control Flag	Char 1	N/A
Serial ID	Char 35	N/A
Staged Date Flag	Char 1	N/A
Staged Date	Date 10	N/A
Actual Cost Flag	Char 1	This field is set to <i>Y</i> if the item is actual-costed.
Unit of Measure	Char 3	N/A

Item Storage Label Field Name	Format	Desc./Com.
Quantity	Nbr 11.4	N/A
Standard Unit of Measure	Char 3	N/A
Standard Quantity	Nbr 11.4	N/A
Reference Number	Char 30	N/A

Storage Container Label

The label extract file record definitions define the format for the label extract file.

Storage Container Label Field Name	Format
Label Format ID	Char 30
Container Number	Nbr 18

Storage Location Label

The label extract file record definitions define the format for the label extract file.

Storage Location Label Field Name	Format
Label Format ID	Char 30
Business Unit	Char 10
Storage Location	Char 5
Storage Level 1	Char 4
Storage Level 2	Char 4
Storage Level 3	Char 4
Storage Level 4	Char 4

Shipping Carton Label

The label extract file record definitions define the format for the label extract file.

Shipping Carton Label Field Name	Format	Desc./Com.
Label Format ID	Char 30	N/A
Ship From Location	Char 30	N/A
Ship From Address1	Char 55	N/A
Ship From Address2	Char 55	N/A
Ship From Address3	Char 55	N/A
Ship From Address4	Char 55	N/A
Ship From Num1	Char 6	N/A
Ship From Num2	Char 4	N/A
Ship From House Type	Char 2	N/A
Ship From City	Char 30	N/A
Ship From Country	Char 30	N/A
Ship From Addr field1	Char 2	N/A
Ship From Addr field2	Char 4	N/A
Ship From Addr field3	Char 4	N/A
Ship From Geo Code	Char 11	N/A
Ship From In City Limit	Char 1	N/A
Ship From State	Char 4	N/A
Ship From Postal	Char 12	N/A
Ship From Country	Char 3	N/A

Shipping Carton Label Field Name	Format	Desc./Com.
Customer Name	Char 40	N/A
Customer Name1	Char 40	N/A
Customer Name2	Char 40	N/A
Address1	Char 55	N/A
Address2	Char 55	N/A
Address3	Char 55	N/A
Address4	Char 55	N/A
Num1	Char 6	N/A
Num2	Char 4	N/A
House Type	Char 2	N/A
City	Char 30	N/A
County	Char 30	N/A
State	Char 4	N/A
Postal	Char 12	N/A
Country	Char 3	N/A
Addr field1	Char 2	N/A
Addr field2	Char 4	N/A
Addr field3	Char 4	N/A
Geo Code	Char 11	N/A
In City Limit	Char 1	N/A

Shipping Carton Label Field Name	Format	Desc./Com.
Carrier	Char 30	N/A
Ship To Customer ID/or Location	Char 15	This field contains either the ship to customer ID or the location, depending on the field that you used when you created the order.
Route Code	Char 6	N/A
Route Stop Number	Number 5	N/A
Customer PO	Char 25	N/A
Customer PO Line	Char 11	N/A
Customer Contract Number	Char 25	N/A
Customer Contract Line Number	Char 3	N/A
Customer Item Number	Char 40	N/A
Business Unit	Char 10	N/A
Demand Source	Char 2	N/A
Source Business Unit	Char 5	N/A
Order Number	Char 10	N/A
Order Line Number	Nbr 5	N/A
Schedule Line Number	Nbr 7	N/A
Inventory Item ID	Char 40	N/A
Demand Line Number	Nbr 4	N/A
Product ID	Char 40	N/A
Parent Product ID	Char 40	N/A

Shipping Carton Label Field Name	Format	Desc./Com.
Lot Control Flag	Char 1	N/A
Standard Serial Control Flag	Char 1	N/A
Staged Date Control Flag	Char 1	N/A
Actual Cost Flag	Char 1	This field is set to <i>Y</i> if the item is actual-costed.
Ship Serial Control Flag	Char 1	N/A
Pick Batch ID	Nbr 10	N/A
Pick Batch Line Number	Nbr 5	N/A
Carton Qty in Ordering UOM	Nbr 11.4	N/A
Ordering UOM	Char 3	N/A
Carton Qty in Standard UOM	Nbr 11.4	N/A
Standard UOM	Char 3	N/A
Carton Qty in Standard Pack UOM	Nbr 11.4	N/A
Standard Pack UOM	Char 3	N/A
Carton Sequence	Char 10	N/A

Shipping Container Label

The label extract file record definitions define the format for the label extract file.

Shipping Container Label Field Name	Format	Desc./Com.
Label Format ID	Char 30	N/A
Ship From Location	Char 30	N/A

Shipping Container Label Field Name	Format	Desc./Com.
Ship From Address1	Char 55	N/A
Ship From Address2	Char 55	N/A
Ship From Address3	Char 55	N/A
Ship From Address4	Char 55	N/A
Ship From Num1	Char 6	N/A
Ship From Num2	Char 4	N/A
Ship From House Type	Char 2	N/A
Ship From City	Char 30	N/A
Ship From County	Char 30	N/A
Ship From State	Char 4	N/A
Ship From Postal	Char 12	N/A
Ship From Country	Char 3	N/A
Ship From Addr field1	Char 2	N/A
Ship From Addr field2	Char 4	N/A
Ship From Addr field3	Char 4	N/A
Ship From Geo Code	Char 11	N/A
Ship From In City Limit	Char 1	N/A
Customer Name	Char 40	N/A
Customer Name1	Char 40	N/A
Customer Name2	Char 40	N/A

Shipping Container Label Field Name	Format	Desc./Com.
Address1	Char 55	N/A
Address2	Char 55	N/A
Address3	Char 55	N/A
Address4	Char 55	N/A
Num1	Char 6	N/A
Num2	Char 4	N/A
House Type	Char 2	N/A
City	Char 30	N/A
County	Char 30	N/A
State	Char 4	N/A
Postal	Char 12	N/A
Country	Char 3	N/A
Carrier	Char 30	N/A
Ship To Customer ID or Location	Char 15	This field contains either the ship to customer ID or the location, depending on the field that you used when you created the order.
Manufacturer ID Number	Char 7	N/A
Shipping Container Serial Number	Nbr 9	N/A
Carton Sequence	Char 10	N/A
Business Unit	Char 10	N/A

Shipping Serial Number Label

The label extract file record definitions define the format for the label extract file.

Serial Number Label Field Name	Format
Label Format ID	Char 30
Serial ID	Nbr 35

Production Completion Label

The label extract file record definitions define the format for the label extract file.

Production Completion Label Field Name	Format	Desc./Com.
Label Format ID	Char 30	N/A
Business Unit	Char 10	See note.
Production ID	Char 10	N/A
Production Area	Char 10	N/A
Item ID	Char 40	See note.
Item Description 30	Char 30	N/A
Configuration Code	Char 50	N/A
Revision	Char 4	N/A
Production Type	Char 2	N/A
Lot Control Flag	Char 1	N/A
Serial Control Flag	Char 1	N/A
Staged Date Flag	Char 1	N/A
Actual Cost Flag	Char 1	N/A

Production Completion Label Field Name	Format	Desc./Com.
Lot ID	Char 15	N/A
Standard Unit of Measure	Char 3	N/A
Standard Pack Quantity	Nbr 11.4	N/A
Std Pack Unit of Measure	Char 3	N/A
Quantity in Std Pack UOM	Nbr 11.4	N/A
Date	Date	CCYYMMDD
Op Sequence	Number 4.0	N/A
Output Type	Char 2	N/A

Note: Certain fields allow for possible larger sizes to accommodate customer revisions. In general, field sizes should match that within the PeopleSoft COBOL programs. Online pages use the sizes as defined within PeopleSoft Application Designer. A size mismatch between the file and the definition may result in an error when data is retrieved through the flat file.

Purchasing Receipt Label

The label extract file record definitions define the format for the label extract file.

Receiving Label Field Name	Format
Label Format ID	Char 30
Inventory Business Unit	Char 10
Item ID	Char 40
Item Description	Char 30
Lot Control Flag	Char 1
Lot ID	Char 15
Serial Control Flag	Char 1

Receiving Label Field Name	Format
Serial ID	Char 35
Receipt Date	Date 10
Actual Cost Flag	Char 1
Receiving Business Unit	Char 5
Receiver ID	Char 10
Receiver Line Number	Nbr 5
Unit of Measure	Char 3
Quantity	Nbr 11.4
Standard Unit of Measure	Char 3
Standard Quantity	Nbr 11.4
Production ID	Char 10
Production Sequence Number	Nbr 2
Staged Date Flag	Char 1

Kanban Card and Pull Ticket Label

The label extract file record definitions define the format for the label extract file.

Kanban Field Name	Type
Label Format ID	Char 30
Business Unit	Char 10
Report Type <ul style="list-style-type: none"> • 2 = Pull Ticket • 3 = Kanban Card 	Char 1

Kanban Field Name	Type
Replenishment Source <ul style="list-style-type: none"> • 1 = Inventory • 2 = Supplier • 3 = Feeder Line 	Char 1
Kanban ID	Char 15
Item ID	Char 40
Item Description	Char 30
WIP Storage Area	Char 5
WIP StorageLevel 1	Char 4
WIP StorageLevel 2	Char 4
WIP StorageLevel 3	Char 4
WIP StorageLevel 4	Char 4
Source Storage Area Blank if Replenishment Source <> INV	Char 5
Source StorageLevel 1 Blank if Repl Source <> INV	Char 4
Source StorageLevel 2 Blank if Repl Source <> INV	Char 4
Source StorageLevel 3 Blank if Repl Source <> INV	Char 4
Source StorageLevel 4 Blank if Repl Source <> INV	Char 4

Kanban Field Name	Type
Production Area Blank if Repl Source <> Feeder	Char 10
Supplier ID Blank if Repl Source <> Supplier	Char 10
Supplier Name Blank if Repl Source <> Supplier	Char 40
Supplier Location Blank if Repl Source <> Supplier	Char 10
Supplier Location Desc Blank if Repl Source <> Supplier	Char 30
Supplier Item ID Blank if Repl Source <> Supplier	Char 20
Supplier Qty Blank if Repl Source <> Supplier	Number 11.4
Supplier UOM Blank if Repl Source <> Supplier	Char 3
Qty Standard UOM	Number 11.4
Standard UOM	Char 3
Lot Control Flag	Char 1
Serial Control Flag	Char 1
Print Count	Number 3
DateTime Stamp	Datetime 14

Picking Plan Extract File Record Definitions

The system generates this optional extract file at the same time that it initiates the picking plan. Its content mimics the data contained within the printed picking plan document and provides an electronic means for the front-end (hand-held or batch) process to validate and enhance data collection. Data in the file is comma-separated.

The picking plan extract file includes five control flags that identify characteristics of the item or component being picked:

Field or Control	Description
Lot Control Flag	Set to <i>Y</i> if the item is lot-controlled. Set to <i>N</i> if the item is not lot-controlled.
Serial Control Flag	Set to <i>Y</i> if the item is serial-controlled. Set to <i>N</i> if the item is not serial-controlled.
Staged Date Control Flag	Set to <i>Y</i> if the item is staged-date controlled. Set to <i>N</i> if the item is not staged-date controlled.
Actual Cost Control Flag	Set to <i>Y</i> if the item is actual-costed. Set to <i>N</i> if the item is not actual-costed.
Shipping Serial Control Flag	Set to <i>Y</i> if the item is shipping serial-controlled. Set to <i>N</i> if the item is not shipping serial-controlled. The shipping serial control flag is only included in the Inventory picking extract file.

Related Links

"Using the Order Release Request Run Control" (PeopleSoft Inventory)

Inventory Picking Extract File Format

The system generates the inventory picking extract file at the same time that it initiates the pick plan.

Picking Plan Extract File Field Name	Format
Business Unit*	Char 10
Extract Source Flag*	Char 1
Pick Batch ID	Nbr 10
Pick List Line Number	Nbr 5

Picking Plan Extract File Field Name	Format
Sequence Number	Nbr 2
Pick Mode Flag*	Char 1
Customer ID	Char 15
Ship To Customer ID	Char 15
Location	Char 10
Demand Source	Char 2
Source Business Unit	Char 5
Order Number	Char 10
Order Int Line Number	Nbr 5
Schedule Line Number	Nbr 4.2
Parent Product ID	Char 18
Item ID*	Char 40
Item Description 30	Char 30
Item Configuration Code	Char 50
Container ID	Char 10
Storage Area	Char 5
Storage Level 1	Char 4
Storage Level 2	Char 4
Storage Level 3	Char 4
Storage Level 4	Char 4

Picking Plan Extract File Field Name	Format
Order/Pick Quantity in Standard UOM	Nbr 11.4
Order/Pick Quantity in Order/Pick UOM	Nbr 11.4
Reserved Quantity in Standard UOM	Nbr 11.4
Reserved Quantity in Location UOM	Nbr 11.4
Available Quantity in Standard UOM	Nbr 11.4
Available Quantity in Location UOM	Nbr 11.4
Standard UOM	Char 3
Order/Pick UOM	Char 3
Location UOM	Char 3
Order UOM Conversion Rate	Nbr 7.8
Location UOM Conversion Rate	Nbr 7.8
Lot ID	Char 15
Serial ID	Char 35
Staged Date*	Char 8
Lot Control Flag	Char 1
Serial Control Flag	Char 1
Staged Date Control Flag	Char 1
Ship Serial Control Flag	Char 1
Hard Allocation Flag	Char 1
Partial Quantity Flag	Char 1

Picking Plan Extract File Field Name	Format
Hard Allocation Flag	Char 1
Partial Quantity Flag	Char 1
Substitute Flag	Char 1
Qty Precision for Std UOM	Char 1
Rounding Rule for Std UOM	Char 1
Qty Precision for Loc UOM	Char 1
Rounding Rule for Loc UOM	Char 1
Allow Overpick Flag	Char 1
Maximum Picking Tolerance	Nbr 3.2
Load ID	Char 10
Carrier ID	Char 10
Ship Via	Char 10
Route Code	Char 6
Route Stop Number	Nbr 5
Lot Availability Date CCYYMMDD	Char 8
Lot Retest Date CCYYMMDD	Char 8
Lot Expiration Date CCYYMMDD	Char 8
Scheduled Ship Date CCYYMMDD	Char 8
ASRS ID	Nbr 15
Picking Zone	Char 6

Picking Plan Extract File Field Name	Format
Original Item ID	Char 40
Original or Reprint Flag *	Char 1
Date / Time Stamp*	Char 14

Field-Specific Notes

See the field-specific information that follows.

Business Unit

The **Business Unit** field permits possible larger sizes to accommodate customer revisions. In general, field sizes should match that within the PeopleSoft COBOL programs. Online pages use the sizes as defined within PeopleSoft Application Designer.

Extract Source Flag

0 = Inventory Pick Plan

1 = Manufacturing Pick Plan

Pick Mode Flag

0 = Push

1 = Pull

Item ID

The **Item ID** field permits possible larger sizes to accommodate customer revisions. In general, field sizes should match that within the PeopleSoft COBOL programs. Online pages use the sizes defined within PeopleSoft Data Designer.

Staged Date

The format is CCYYMMDD.

Original or Reprint Flag

0 = Original

1 = Reprint

Date / Time Stamp

The format is CCYYMMDDHHMMSS.

Manufacturing Picking Extract File Format

The system generates the manufacturing extract file at the same time that the system initiates the pick plan.

Note: For manufacturing extract data, the control flags reflect the requirements for the component ID, not the item ID.

Picking Plan Extract File Field Name	Format
Business Unit*	Char 10
Extract Source Flag*	Char 1
Pick Batch ID	Nbr 10
Pick List Line Number	Nbr 5
Sequence Number	Nbr 2
Pick Mode Flag*	Char 1
Production Area	Char 10
Production ID	Char 10
Production Type*	Char 2
Issue Method*	Char 4
Item ID*	Char 40
Item Description 30	Char 30
Item Configuration Code	Char 50
Original Component ID	Char 40
Component ID	Char 40
Component Description 30	Char 30
Component Configuration Code	Char 50

Picking Plan Extract File Field Name	Format
Operation Sequence	Nbr 4
Quantity Code*	Char 3
Required Date*	Char 8
Required Time*	Char 6
Work Center Code	Char 10
Work Center Description	Char 30
To Container ID	Char 10
To Storage Area	Char 5
To Storage Level 1	Char 4
To Storage Level 2	Char 4
To Storage Level 3	Char 4
To Storage Level 4	Char 4
Container ID	Char 10
Storage Area	Char 5
Storage Level 1	Char 4
Storage Level 2	Char 4
Storage Level 3	Char 4
Storage Level 4	Char 4
ASRS ID	Nbr 15
Order/Pick Quantity in Standard UOM	Nbr 11.4

Picking Plan Extract File Field Name	Format
Order/Pick Quantity in Order/Pick UOM	Nbr 11.4
Reserved Quantity in Standard UOM	Nbr 11.4
Reserved Quantity in Location UOM	Nbr 11.4
Available Quantity in Standard UOM	Nbr 11.4
Available Quantity in Location UOM	Nbr 11.4
Standard UOM	Char 3
Order/Pick UOM	Char 3
Location UOM	Char 3
Order/Pick UOM Conversion Rate	Nbr 7.8
Location UOM Conversion Rate	Nbr 7.8
Lot ID	Char 15
Lot Expiration Date	Char 8
Lot Availability Date	Char 8
Serial ID	Char 35
Lot Control Flag	Char 1
Serial Control Flag	Char 1
Staged Date Control Flag	Char 1
Actual Cost Control Flag	Char 1
Maintain Production ID Flag	Char 1
Non Own Flag	Char 1

Picking Plan Extract File Field Name	Format
Original or Reprint Flag*	Char 1
Substitute Flag	Char 1
Date / Time Stamp*	Char 14

Field-Specific Notes

See the field-specific-information that follows.

Business Unit

The **Business Unit** field permits possible larger sizes to accommodate customer revisions. In general, field sizes should match that within the PeopleSoft COBOL programs. Online pages use the sizes defined within PeopleSoft Data Designer.

Extract Source Flag

0 = Inventory Pick Plan

1 = Manufacturing Pick Plan

Pick Mode Flag

0 = Push

1 = Pull

Production Type

PR = Production

RW = Rework

TD = Teardown

Issue Method

ISS = Issue

REPL = Replenish

KIT = Kit

Item ID

This field permits possible larger sizes to accommodate customer revisions. In general, field sizes should match that within the PeopleSoft COBOL programs. Online pages use the sizes defined within PeopleSoft Data Designer.

Quantity Code

ORD = per Order

ASY = per Assembly

Required Date

The format is CCYYMMDD.

Required Time

The format is HHMMSS.

Original or Reprint Flag

A reprinted extract reflects the current data values in the database. If any pick transactions have been applied between the original and reprinted extract, the data content may differ.

0 = Original

1 = Reprint

Date / Time Stamp

The format is CCYYMMDDHHMMSS.

Integrating with Transportation Management Systems

Understanding the Transportation Management System Integration with PeopleSoft Inventory

A TMS is used to optimize the grouping of orders into shipments for distribution out of a warehouse. Order information is sent to the TMS and load optimization is performed on the orders to be shipped. The TMS determines the load ID for each of the demand lines. The demand lines are returned to the PeopleSoft fulfillment tables with a load ID.

To support implementations in which a third-party system is used to allow shippers and carriers to maximize space utilization of existing loads, and thereby minimizing shipping costs, PeopleSoft provides two EIPs. These EIPs consist of:

- TMS Order Release—an asynchronous outbound service operation within PeopleSoft Integration Broker that releases orders to a TMS.
- TMS Load Notification—a synchronous service operation (TMS_LOAD_NOTIFICATION_REQ) and an asynchronous inbound service operation (TMS_LOAD_NOTIFICATION) that can load TMS notifications in PeopleSoft Inventory.

This diagram shows the process flow of the integration between PeopleSoft Inventory's demand fulfillment cycle and a third-party TMS system:

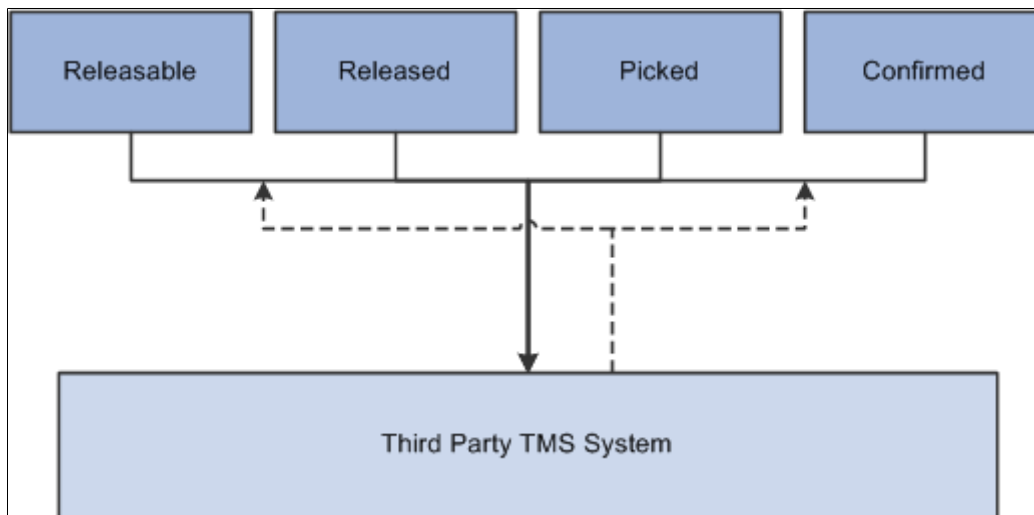

Shipment Definition

As it relates to PeopleSoft Inventory and TMS, a shipment is a unit of work that can be thought of as the product to be delivered to a customer, at a specific location, on a specific date, by a specific method of delivery. At most, it is represented by an order in the PeopleSoft system.

Within the order, many factors would determine whether the order is comprised of more than one shipment. For example, the difference in primary fields such as: multiple delivery locations and schedule dates, or specifying different carriers for different demand lines are values that would cause the order to be treated as multiple shipments.

For purposes of load creation in the TMS, outbound information must be organized into logical shipments. A shipment is the distinct combination of these fields:

- BUSINESS_UNIT
- DEMAND_SOURCE
- SOURCE_BUS_UNIT
- ORDER_NO
- SHIP_TO_CUST_ID
- ADDRESS SEQ NUM
- LOCATION
- COUNTRY
- POSTAL
- STATE
- COUNTY
- CITY
- HOUSE_TYPE
- NUM1
- NUM2
- ADDRESS1
- ADDRESS2
- ADDRESS3
- ADDRESS4
- ADDR_FIELD1
- ADDR_FIELD2
- ADDR_FIELD3

- SHIP_CUST_NAME1
- SHIP_CUST_NAME2
- SCHED_DATE / TIME
- SHIP_EARLY_DATE / TIME
- SHIP_LATE_DATE / TIME
- SCHED_ARRV_DTTM
- LOAD_ID
- CARRIER_ID
- SHIP_TYPE_ID
- FREIGHT TERMS

Synchronize Customer and Location Information

In addition to sending order release information to the TMS, you can synchronize customer and location information by using the PeopleSoft Order Management Customer EIPs (service operations starting with CUSTOMER) and the PeopleSoft Inventory Location EIPs (service operations starting with LOCATION).

Related Links

"EIPs for Fulfillment Transactions" (PeopleSoft Inventory)

"Setup Fulfillment-Transportation Interface Page" (PeopleSoft Inventory)

"Carrier Page" (Application Fundamentals)

Setting Up PeopleSoft for TMS Integration

This section discusses how to set up PeopleSoft for TMS integration.

Pages Used to Set Up PeopleSoft for TMS Integration

<i>Page Name</i>	<i>Definition Name</i>	<i>Usage</i>
Carrier Page	CARRIER_TBL	Indicate if order lines that have a specific carrier should or should not be downloaded to the TMS system.
Auto Numbering Page	AUTO_NUM_PNL	To set up the TMS Reference ID numbering scheme, use the Auto Numbering component.

Page Name	Definition Name	Usage
Setup Fulfillment-Transportation Interface Page	OF_SETUP_INV	Determine the structure of the TMS data sent to and received by the TMS.

Setting up the TMS Integration

Before you can perform the PeopleSoft Inventory to TMS integration, you must:

- Activate the TMS_ORDER_RELEASE, TMS_LOAD_NOTIFICATION, or TMS_LOAD_NOTIFICATION_REQ service operations within PeopleSoft Integration Broker.

See "Transportation Management System EIPs" (PeopleSoft Inventory).

- Activate the associated batch publish rule for the TMS Order Release service operation.
- Set up the carrier table for carriers that should not be sent to the TMS.
- Set up auto numbering for the TMS Reference ID.
- Set up transportation interface options on the Setup Fulfillment page.

Some setup considerations are:

- The lead time needed to send data to the TMS, process data on the TMS, and sending data back to PeopleSoft Inventory.
- Your typical volume of change orders:
 - If you don't have a lot of change orders, you can download demand lines from PeopleSoft to the TMS sooner in the demand fulfillment process. You do not have to create, resend, remove, or cancel transactions from change orders.
 - If you do have a lot of change orders, you may want to download demand lines from PeopleSoft to the TMS later in the demand fulfillment process. This way you can avoid having to create resend, remove, or cancel transactions from changed orders.
- Handling orders that have a carrier assigned prior to downloading to the TMS. As PeopleSoft Order Management allows you to define carrier defaults at a customer and order level, the demand line may have a carrier assigned prior to downloading to the TMS. If you want the TMS to determine the carrier, you will have to decide whether the TMS will ignore the carrier default and assign a new one, or use the carrier default assigned by PeopleSoft applications.

Note: If the TMS is to ignore the carrier, or any other field, that is assigned by PeopleSoft, you must determine this on the TMS or modify the TMS_ORDER_RELEASE service operation.

- Handling updates to the customer, location, UOM, and item weight and volume tables.

PeopleTools: Integration Broker

Related Links

[Setting Up Service Operations](#)

Publishing the TMS Order Release EIP

This section provides an overview of the TMS order release process and discusses how to send TMS data from PeopleSoft Inventory to the TMS and communicate order changes to the TMS

Pages Used to Publish the TMS Order Release EIP

<i>Page Name</i>	<i>Definition Name</i>	<i>Usage</i>
Publish Outbound Message Page	IN_RUN_PUB_MSG	Select the TMS Order Release check box to activate the link.
TMS Order Release Selection Criteria Page	IN_RUN_TMSREL	Select which order lines are to be processed for this run control.

Understanding the TMS Order Release Process

Demand lines are eligible for the initial download to the TMS:

- If they are in a releasable state, but not shipped.
- If they do not have a TMS External Reference ID assigned to them.
- If they do not have a route number assigned to them.

Demand lines on the PeopleSoft system are pulled from IN_DEMAND. During this process, the table is updated with the TMS External Reference ID and the TMS Reference Line Number, and the TMS process flag is set to "Y." The TMS process flag indicates that the line has been sent to the TMS and is waiting for the load assignment. The TMS External Reference ID is used as the reference number between the PeopleSoft system and the TMS system.

Demand lines are grouped into logical shipments and the TMS utilizes this information to group shipments into a load:

- The TMS External Reference ID and Line Number.
- Demand line information that is related to the order.
- The customer or destination location address.
- Any note or comment information on the order header or line.

New rows of data are added to the TMS system.

Note: The addition of new demand lines to an order, with rows that have already been assigned a TMS External Reference ID and transmitted to the TMS, must be handled as an initial download transaction. If an initial download is initiated, the new line will be selected as a line not having a TMS External Reference ID, and will be assigned a TMS External Reference ID and a TMS Reference Line Number. In other words, if a line is added to an order that has been sent to the TMS, a resend transaction will not add the line to the existing TMS External Reference ID. The initial download will send the new line and a new TMS External Reference ID is assigned to it. If you prefer to combine the new line with the orders' TMS External Reference ID, you must remove the original ID and re-initiate an initial download for the order.

Processing Holds

It is important to understand how the PeopleSoft system processes demand lines that are on hold.

If a demand line is sourced from PeopleSoft Inventory, and the Check for Holds option is selected on the Setup Fulfillment-Transportation Interface page, and it is on hold, then the demand line is not sent to the TMS.

If a demand line is sourced from PeopleSoft Order Management, and the Check for Holds option is selected on the Setup Fulfillment-Transportation Interface page, and the demand line cannot proceed to the next state, then the demand line is not sent to the TMS.

This diagram illustrates an example of a sales order that has lines that are not sent to the TMS. This order contains five lines in different fulfillment states; three are releasable, one is released, and one is confirmed. If PeopleSoft Order Management is set up so that each order line is held at a released state, then lines 1, 2, and 5 will not be sent to the TMS. However, lines 3 and 4 will be sent to the TMS because line 3 is already at a released state, and line 4 is past a released state.

This diagram illustrates an example of a sales order that has lines that are not sent to the TMS.

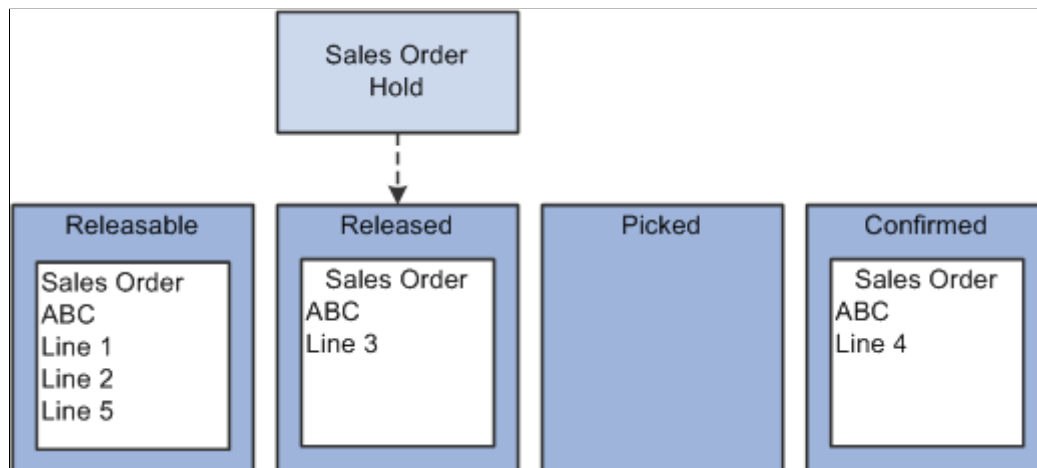

Related Links

"Understanding Sales Order Holds in PeopleSoft Order Management" (PeopleSoft Order Management)

TMS Order Release Selection Criteria Page

Use the TMS_ORDER_RELEASE EIP to send demand data from PeopleSoft Inventory to the TMS.

Use the TMS Order Release Selection Criteria page (IN_RUN_TMSREL) to select which order lines are to be processed for this run control.

Navigation:

Select the TMS Order Release check box on the Publish Outbound Message page, and click the TMS Order Release link.

This example illustrates the fields and controls on the TMS Order Release Selection Criteria page. You can find definitions for the fields and controls later on this page.

Field or Control	Description
Process Option	Select one of these options to run the IN_TMSORDREL application engine process: <i>Initial Download:</i> Select to send order lines to the TMS for the first time. <i>Re-send Shipment:</i> Select to send changes to order lines that were previously sent to the TMS. <i>Remove Shipments:</i> Select to request that all rows of shipment be physically deleted from the TMS system.
Include Cancellations	Select this option to remove all rows of a shipment from the TMS. This option is used to remove shipments that have an unfulfilled state in PeopleSoft Inventory or Order Management.
TMS Reference ID	Select a value if you are resending or removing a shipment. This option is used when change orders occur or to identify a specific TMS Reference ID.

Field or Control	Description
Inquire Cancels	Select this link to view all orders that have an unfulfilled state and will be downloaded to the TMS if you select the Include Cancels option.

Note: The TMS Reference ID is created from auto numbering setup on the PeopleSoft system. This ID is assigned to each order line selected during the Publish Outbound Message process.

Communicating Order Changes to the TMS

This section provides an overview of order changes and discusses:

- Using the resend outbound transaction.
- Using the remove outbound transaction.
- Using the cancel outbound transaction.

Understanding Order Changes

Demand lines can change within PeopleSoft Inventory and Order Management after they have been sent to the TMS.

The change may be to a primary field or to a secondary field.

- Examples of a primary field are:
 - The schedule date.
 - The destination location or address.
 - The carrier.
- Examples of a secondary field are:
 - The unit of measure.
 - The quantity.

If a change is made to a demand line that has been sent to the TMS, it is your responsibility to update the TMS.

There are three options to communicate demand changes to the TMS:

- Use the resend outbound transaction.
- Use the remove outbound transaction.
- Use the cancel outbound transaction.

Using the Resend Outbound Transaction

This option is used if changes are made to secondary fields, or if lines are canceled from an order.

A resend transaction provides the ability to send changes to demand lines that were previously sent to the TMS.

The TMS uses an action of *Add* for this transaction and if the TMS External Reference ID exists on the database, it deletes the associated row and adds the new row.

Using the Remove Outbound Transaction

This option is used if changes are made to primary fields, and can be followed by the initial download-outbound transaction.

This transaction is created at the business unit and TMS External Reference ID level.

It requests that all rows for a shipment be physically deleted from the TMS system.

The TMS upload flag and the TMS External Reference ID are initialized for the demand lines for which the delete transaction is performed on the PeopleSoft system.

Using the Cancel Outbound Transaction

This option is used if an order has an unfulfilled state in PeopleSoft Inventory or Order Management.

This transaction is created at the business unit and TMS External Reference ID level.

It requests that all rows for a shipment be physically deleted from the TMS system.

Understanding TMS Processing

In general, the TMS system is typically used to determine these values:

- The best carrier to use for the shipment.
- The best delivery method to use for the shipment.
- The ship date and the arrival date.
- The load ID.
- The stop number.

If multiple shipments are combined into a load, the stop number is used to determine the order to load the delivery container so that it may be unloaded efficiently, that is in the stop order.

The primary fields, sent from the PeopleSoft system, for each line of an order determine how many shipments the TMS will create. Within an order, in general, if it's going to the same customer, the same location, on the same date, using the same ship method, PeopleSoft will consider this one shipment. Auto numbering setup will determine the External Reference ID, which is assigned to the shipment during the download process and used for identification purposes.

Shipment data is typically held in the TMS until one of these conditions are met:

- The TMS has enough information to create a full load.
- The delivery vehicle is full.
- The scheduled ship date is approaching.

Receiving the Load Notification EIP

This section provides an overview of the load notification process and discusses how to upload TMS data from the TMS to PeopleSoft Inventory and view and correct errors.

Pages Used to Subscribe to the Load Notification EIP

<i>Page Name</i>	<i>Definition Name</i>	<i>Usage</i>
<u>TMS Load Notification Page</u>	BCT_INV_TMSLOAD	Launch the IN_TMSUPLOAD Application Engine process, which pulls the TMS transactional data from the BCT tables and updates IN_DEMAND and LOAD_INV.
<u>Transaction Maintenance Page</u>	BCT_CTL_UPD	View and change the status of error messages found during the TMS Load Notification process.
Transportation Management Page	BCT_TMS_UPD_INV	View and correct error messages found during the TMS Load Notification process.

Understanding the Load Notification EIP Process

This diagram shows the process flow of data from the TMS to PeopleSoft Inventory. The PeopleSoft Integration Broker processes the incoming transaction data from the Load Notification service operation and places the data in the BCT staging tables. The TMS Load Notification process pulls the data from the BCT tables and updates the PeopleSoft Inventory tables: IN_DEMAND and LOAD_INV:

This diagram shows the process flow of data from the TMS to PeopleSoft Inventory.

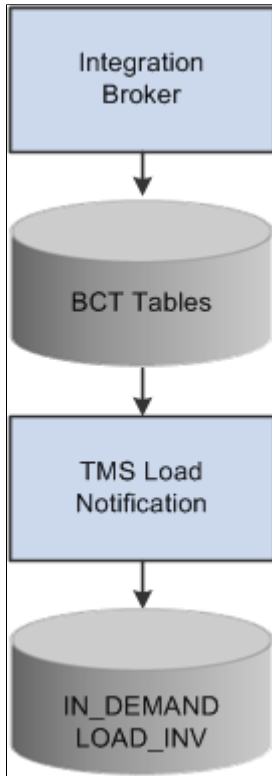

TMS Load Notification Page

Use the TMS Load Notification page (BCT_INV_TMSLOAD) to launch the IN_TMSUPLOAD Application Engine process, which pulls the TMS transactional data from the BCT tables and updates IN_DEMAND and LOAD_INV.

Navigation:

SCM Integrations, Process Transactions, Inventory, TMS Load Notification

This example illustrates the fields and controls on the TMS Load Notification page. You can find definitions for the fields and controls later on this page.

The TMS_LOAD_NOTIFICATION EIP pulls TMS information from the BCT tables and performs error checking.

Depending on where the order line is within the fulfillment process, this process will find the order line and update these values:

- The load ID.
- The load stop number.
- The shipping method.
- The carrier.
- The shipment dates.

PeopleSoft load management (LOAD_INV) is updated with the load ID, the carrier, the ship method, and the schedule date from the TMS.

If the TMS changes the scheduled arrival date for an interunit MSR that is supply pegged, and is sourced from PeopleSoft Planning or Inventory, an email message is sent notifying the user of the change.

See *PeopleSoft: Events and Notifications*

The TMS Process flag is turned off and the shipment may be processed.

The load ID is an optional field during this process. For example, the TMS may determine that the order should be shipped through an outside carrier. If this occurs, the shipment may be returned to PeopleSoft with the carrier and ship via assigned, but without a load ID.

The TMS can send a delete transaction to PeopleSoft, which will remove all of the load information from demand lines and reset the TMS process flag.

Field or Control	Description
All EIP_CTL_IDs	Select this option to process all EIP control IDs from the BCT tables. This option will process all of the transactional data that has a status of <i>New</i> or <i>Reprocess</i> .
From and To	Enter the specific EIP Control ID. These fields have search buttons when the All EIP_CTL_IDs option is not selected.

Transaction Maintenance Page

Use the Transaction Maintenance page (BCT_CTL_UPD) to view and change the status of error messages found during the TMS Load Notification process.

Navigation:

SCM Integrations, Transaction Error Handling, Maintain Transactions

The Transaction Maintenance page reads the BCT tables and is used to view and change the status of error messages that are found during the upload process.

Use the Transportation Management page (BCT_TMS_UPD_INV) to view and correct error messages found during the TMS Load Notification process.

Navigation:

Click the **EIP Control ID** link from the Transaction Maintenance page.

The Transportation Management page provides details of the error message. There can be three levels of message rows; one for the load, one for the order, and one for the line. Each row will display different fields depending on the level of the message.

Related Links

[PeopleSoft SCM Inbound EIPs](#)

Integrating with PeopleSoft CRM

Understanding PeopleSoft SCM Integration with PeopleSoft CRM

You use EIPs to seamlessly integrate your (SCM) applications to PeopleSoft (CRM). While you can use these EIPs to integrate with other technologies, your setup steps can be different if you are integrating to PeopleSoft CRM.

Setting Up CRM EIPs

In general, you need to follow a few more steps used to set up EIPs to integrate with PeopleSoft CRM. These steps are unique to each EIP, and thus are found in the PeopleSoft SCM application documentation for each individual EIP. However, some EIPs use different service operations to integrate with PeopleSoft CRM than to other systems. For example, Item Master uses the ITEM_CRM_SYNC_EFF service operation to integrate with PeopleSoft CRM, and ITEM_SYNC or ITEM_SYNC_EFF to integrate with other applications such as a Warehouse Management System.

Processing Inbound CRM EIPs

In general, you follow a few different steps when subscribing to CRM EIPs.

You load inbound XML-based transactions into the PeopleSoft system using subscription processes that are automatically initiated by PeopleSoft's Integration Broker functionality. Once loaded, the system validates the information and if no errors are found, updates the appropriate PeopleSoft application tables. If errors are found, then the data may be corrected and resubmitted for processing.

Processing Outbound CRM EIPs

You can publish outbound XML-based service operations from different points in the system using PeopleSoft's messaging capabilities. If you are publishing an entire table such as items or customers, you use the one time full data publish utility. If you are publishing incremental update service operations, the system automatically publishes service operations with the data when you save the appropriate component.

Common Object Integrations

This section discusses integration of common objects

Syncing Customers, Contacts, and Products

You synchronize products, customers, and contacts by performing a full table publish to the PeopleSoft Order Capture system. PeopleSoft SCM provides updates to the subscribing system with incremental service operations. Products should be maintained in PeopleSoft SCM and published to PeopleSoft CRM. Customers and Contacts may be maintained in both PeopleSoft SCM and CRM.

PeopleSoft Order Management Integration with PeopleSoft Order Capture

PeopleSoft Order Management and PeopleSoft Order Capture sync customer, contact, and product information. They also sync sales order data.

Submitting Quotes

PeopleSoft Order Capture submits a quote (CRM_QUOTE), which is transformed into a subscribe service operation (SALES_CRM_QUOTE_LOAD) to PeopleSoft Order Management. PeopleSoft Order Management sends an acknowledgement of this quote (SALES_QUOTE_NOTICE) to PeopleSoft Order Capture.

Submitting an Order

PeopleSoft Order Capture submits an order (CRM_SALES_ORDER), which is transformed into a subscribe service operation (SALES_CRM_ORDER_LOAD) to PeopleSoft Order Management. PeopleSoft Order Management sends a Sales Order Acknowledgement to PeopleSoft Order Capture.

Maintaining Existing Orders

PeopleSoft Order Capture sends order changes (CRM_SALES_ORDER_CHANGE) which are transformed into a subscribe message (SALES_CRM_ORDER_CHANGE_LOAD) to PeopleSoft Order Management. PeopleSoft Order Management sends an order change acknowledgement (SALES_ORDER_CHANGE_NOTICE) to PeopleSoft CRM.

Checking Order Status

PeopleSoft Order Capture requests current order and order line status (CRM_ORDER_STATUS), transformed into a service operation (SCM_GET_ORD_STATUS) in PeopleSoft Order Management. PeopleSoft Order Management sends back the order status (SALES_ORDER_STATUS) to PeopleSoft Order Capture.

Checking Product Availability

PeopleSoft Order Capture requests product availability information (SCM_GET_PROD_AVAIL) from PeopleSoft SCM.

Shipping an Order

PeopleSoft Order Capture receives advanced shipping notices (ADVANCED_SHIPPING_NOTICE) from PeopleSoft Inventory.

PeopleSoft Billing Integration with PeopleSoft CRM 360 Degree View

PeopleSoft CRM requests and receives invoice information from PeopleSoft Billing.

PeopleTools: Applications User's Guide

Related Links

"Understanding PeopleSoft CRM to Billing Integration" (PeopleSoft Billing)

PeopleSoft SCM Integration with PeopleSoft FieldService

PeopleSoft CRM FieldService requires real-time item balance and availability checks with PeopleSoft Inventory and Purchasing. Inventory sends information to FieldService, including Inventory business units as storage locations for field service trucks and items.

Using CRM EIPs

You use individual EIPs to integrate SCM applications with CRM applications.

CRM EIPs

You can use the following EIPs to integrate with PeopleSoft CRM:

<i>EIP</i>	<i>Technical Name</i>	<i>Functional Definition</i>	<i>SCM Application</i>	<i>CRM Application</i>	<i>Reference</i>
Advanced Shipping Notice	ADVANCED_SHIPPING_NOTICE	Inventory sends PeopleSoft CRM notification that sales orders have been shipped.	Inventory	FieldService, Order Capture	See "Advanced Shipping Notice EIP" (PeopleSoft Inventory).
Bill Source	BILL_SOURCE_FULLSYNC BILL_SOURCE_SYNC	Syncs bill source information with PeopleSoft CRM.	Billing		See "Understanding PeopleSoft CRM to Billing Integration" (PeopleSoft Billing).
Bill Type	BILL_TYPE_FULLSYNC BILL_TYPE_SYNC	Syncs bill type information with PeopleSoft CRM	Billing		See "Understanding PeopleSoft CRM to Billing Integration" (PeopleSoft Billing).
Contact	CONTACT_SYNC_EFF, CONTACT_FULLSYNC_EFF	Syncs contact information with PeopleSoft CRM.	SCM	CRM Common	See "Understanding Contact Information" (PeopleSoft Order to Cash Common Information).

EIP	Technical Name	Functional Definition	SCM Application	CRM Application	Reference
CRM 360 Degree View	BI_EIP360_REQ BI_EIP360_RSP	CRM requests billing information (bills) from PeopleSoft Billing to display in the 360-Degree View. PeopleSoft Billing responds with the billing information requested from the PeopleSoft CRM 360-Degree View	Billing	CRM Common	See "Understanding PeopleSoft CRM to Billing Integration" (PeopleSoft Billing).
Customer	CUSTOMER_FULLSYNC, CUSTOMER_SYNC	Syncs customer information with PeopleSoft CRM.	SCM	CRM Common	See "Understanding Enterprise Integration Points" (PeopleSoft Order to Cash Common Information).
Customer Group	CUSTOMER_GROUP_FULLSYNC, CUSTOMER_GROUP_SYNC	Syncs customer group information with PeopleSoft CRM.	SCM	CRM Common	See "Understanding Enterprise Integration Points" (PeopleSoft Order to Cash Common Information).
InterUnit Receipt	INTERUNIT_RECEIPT	Updates the status of interunit receipts to indicate whether the quantity on the receipt has been received.	Inventory	FieldService	See "Staging Interunit Transfers Using an Electronic Data Collection System" (PeopleSoft Inventory).
Inventory Adjustment	INVENTORY_ADJUSTMENT	Loads inventory adjustments.	Inventory	FieldService	See "Making Adjustments Using the Inventory Adjustment EIP" (PeopleSoft Inventory).
Inventory Item Balance	IN_ITEM_BALANCES	Queries inventory item balance.	Inventory	FieldService	

EIP	Technical Name	Functional Definition	SCM Application	CRM Application	Reference
Item Master	ITEM_CRM_FULLSYNC_EFF, ITEM_CRM_SYNC_EFF	Syncs item information with PeopleSoft CRM.	Inventory	FieldService	See "Setting Up the Item Master EIP" (PeopleSoft Managing Items).
Order Status	OM_ORDER_STATUS	Order Capture requests current order and order line status from Order Management.	Order Management	Order Capture	See "Understanding Product Load EIPs" (PeopleSoft Order to Cash Common Information).
Product	PRODUCT_GROUP_FULLSYNC, PRODUCT_SYNC	Syncs product information with PeopleSoft CRM.	Order Management	Order Capture	See "Understanding Product Load EIPs" (PeopleSoft Order to Cash Common Information).
Product Availability	PSPRODAVAIL	Order Capture queries product availability from Order Management.	Inventory	Order Capture	See "Providing Item Availability Checks to Third-Party Systems" (PeopleSoft Inventory).
Product Group	PRODUCT_GROUP_FULLSYNC, PRODUCT_SYNC	Syncs product group information with PeopleSoft CRM.	Order Management	Order Capture	See "Understanding Product Load EIPs" (PeopleSoft Order to Cash Common Information).
Purchase Order and Interunit Transfer Information	RF_GETPOIUT	Queries PO and IUT Information from CRM	Inventory	FieldService	See "Understanding the Receiving Business Process" (PeopleSoft Purchasing).
Purchase Order Receipt	PURCHASE_ORDER_RECEIPT	Updates the status of purchase order receipts to indicate whether the quantity on the receipt has been received.	Purchasing	FieldService	See "Understanding the Receiving Business Process" (PeopleSoft Purchasing).

EIP	Technical Name	Functional Definition	SCM Application	CRM Application	Reference
Purchase Order Requisition	PURCHASE_ORDER_REQUISITION_CRM	Loads requisition data from PeopleSoft CRM.	Purchasing	CRM Common	See "Creating Requisition Header Information" (PeopleSoft Purchasing).
Sales Order	PSGETID	Order Capture calls this EIP to get the next order number from OM.	Order Management	Order Capture	See "Understanding Sales Order and Quotation EIPs in PeopleSoft Order Management" (PeopleSoft Order Management).
Sales Order Acknowledgement	SALES_ORDER_ACKNOWLEDGEMENT	Order Management publishes an acknowledgement indicating that an order has been received.	Order Management	Order Capture	See "Understanding Sales Order and Quotation EIPs in PeopleSoft Order Management" (PeopleSoft Order Management).
Sales Order Change	SALES_CRM_ORDER_CHANGE_LOAD	Order Management publishes an acknowledgement of changes made to an order that was created using the Sales Order or CRM Sales Order message.	Order Management	Order Capture	See "Understanding Sales Order and Quotation EIPs in PeopleSoft Order Management" (PeopleSoft Order Management).
Sales Order Load	SALES_CRM_ORDER_LOAD, SALES_CRM_QUOTE_LOAD	Order Management loads sales order header, line and shipment information from Order Capture.	Order Management	Order Capture	See "Understanding Sales Order and Quotation EIPs in PeopleSoft Order Management" (PeopleSoft Order Management).
Sales Order Notice	SALES_ORDER_CHANGE_NOTICE	Dispatches a sales order.	Order Management	Order Capture	See "Understanding Sales Order and Quotation EIPs in PeopleSoft Order Management" (PeopleSoft Order Management).

EIP	Technical Name	Functional Definition	SCM Application	CRM Application	Reference
Sales Order Status	SALES_ORDER_STATUS	Publish sales order information, including the order tracking status.	Order Management	Order Capture	See "Understanding Sales Order and Quotation EIPs in PeopleSoft Order Management" (PeopleSoft Order Management).
Sales Quote Notice	SALES_QUOTE_NOTICE	Order Management sends a quote acknowledgement to Order Capture.	Order Management	Order Capture	See "Understanding Sales Order and Quotation EIPs in PeopleSoft Order Management" (PeopleSoft Order Management).
Standard Note	STD_NOTE_FULLSYNC, STD_NOTE_SYNC	Syncs standard note information with PeopleSoft CRM.	Order Management	CRM Common	See "Standard Notes Page" (PeopleSoft Order to Cash Common Information).
Tax Codes	TAX_HEADER_TBL_FULLSYNC	Syncs tax code information with PeopleSoft CRM	Billing		See "Understanding PeopleSoft CRM to Billing Integration" (PeopleSoft Billing).

Integrating with Supply Chain Business Modeler

Understanding the PeopleSoft Supply Chain Management Integration with the Supply Chain Business Modeler

This diagram illustrates the integration between PeopleSoft Supply Chain Management and the Supply Chain Business Modeler. PeopleSoft Supply Chain Management integrates with the Supply Chain Business Modeler (a part of Supply Chain Planning) by passing a wide range of supply chain data to the Supply Chain Business Modeler in the form of XML documents:

Supply Chain Business Modeler

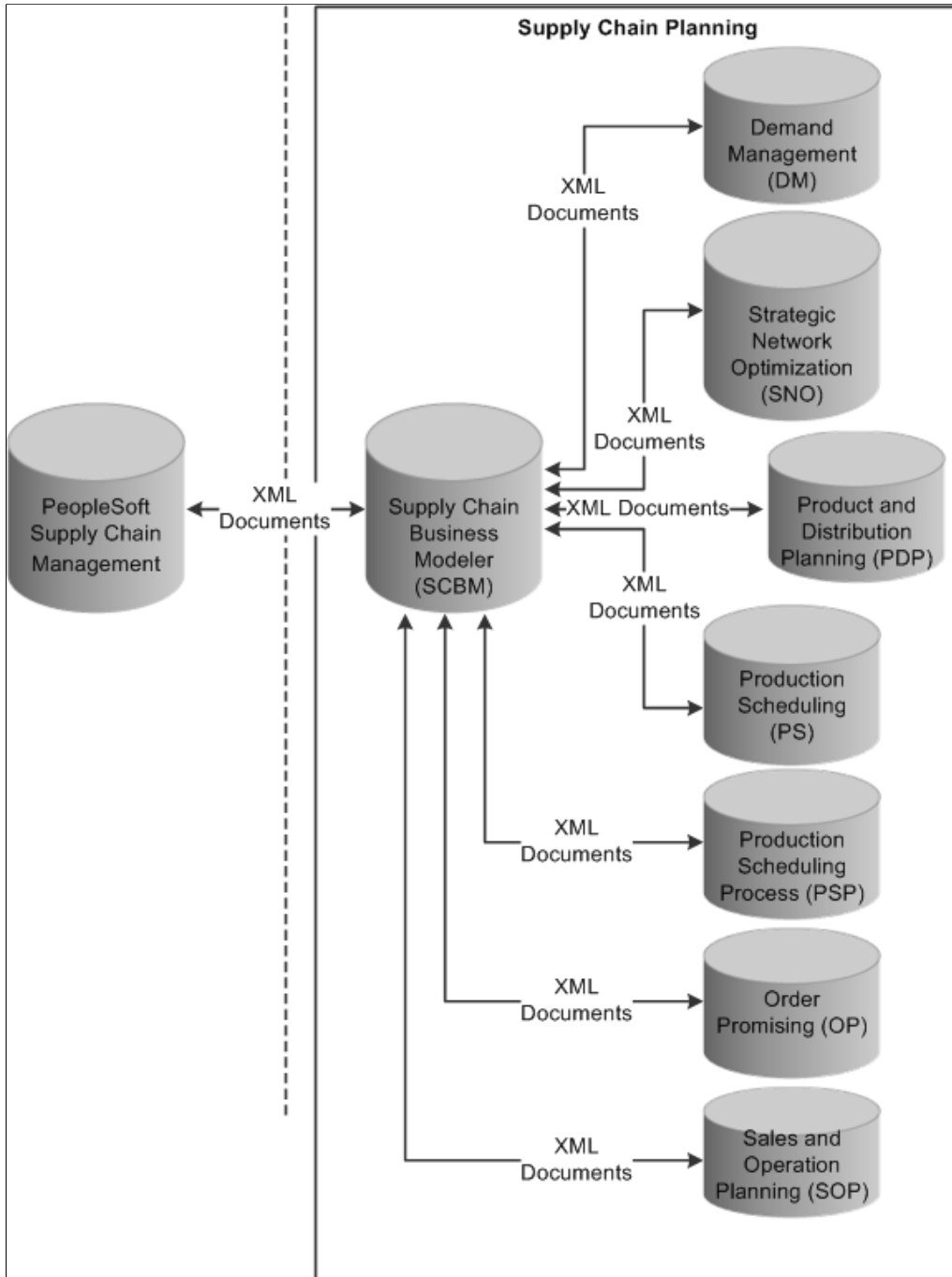

The data that is passed through the XML documents is not planning-model specific but rather a base representation of data that will be used by various planning models. The Supply Chain Business Modeler is a central planning data repository for the Supply Chain Planning Products (Demand Management (DM), Strategic Network Optimization (SNO), Production and Distribution Planning (PDP), Production Scheduling (PS), Production and Scheduling Process (PSP), Order Promising (OP), and Sales and Operation Planning (SOP)).

Once the supply chain management data resides within the Supply Chain Business Modeler it is then used to build tactical, operational, or strategic planning models and model partitions. The model partitions are used to generate data needed for specific Supply Chain Planning products. After the Supply Chain

Planning products are done with their analysis they then pass their individual information (plans) back to the Supply Chain Business Modeler.

At that point, once again PeopleSoft Supply Chain Management integrates with the Supply Chain Business Modeler by importing that planning data back into PeopleSoft Supply Chain Management and acting upon the recommendations from the planning products.

PeopleSoft Predefined XML Documents

PeopleSoft provides the following predefined XML documents for exporting data from PeopleSoft Supply Chain Management to Supply Chain Business Modeler:

<i>XML Document</i>	<i>Associated Data</i>
Configuration	Model parameters
Calendar	Calendar
Base	<ul style="list-style-type: none"> • Item • Standard UOM (unit of measure) • Item UOM (unit of measure) • Item Group • Branch • Branch Group • Storage • Storage Requirement Set • Item Storage • Item Branch • Inventory Policy
Distribution	<ul style="list-style-type: none"> • Lane • Transport Mode • Item Transport Mode
Supplier	<ul style="list-style-type: none"> • Supplier • Supplier Item

<i>XML Document</i>	<i>Associated Data</i>
Customer	Customer
Manufacturing	<ul style="list-style-type: none"> • Operation • Produced Item • Produced Item BOM (bills of material) • Consumed Item BOM (bills of material) • Operation BOR (bill of resources) • Routing • Operation Set • Branch Operation Set • Temporal Relation • Branch Operation • Branch Routing • Resource • Crew • Machine • Tool • Consumed Item Set • Resource Set
Forecasts	<ul style="list-style-type: none"> • Enterprise Forecast • Enterprise Forecast Detail
Sales Orders	<ul style="list-style-type: none"> • Sales Orders • Sales Order Details
Sales Order History	Sales Order History
Transfer Orders	<ul style="list-style-type: none"> • Transfer Order • Transfer Order Detail

XML Document	Associated Data
Beginning Inventory	Beginning Inventory
Work Orders	<ul style="list-style-type: none"> • Work Order • Work Order Routing • Work Order Parts List
Purchase Orders	<ul style="list-style-type: none"> • Purchase Order • Purchase Order Detail
Safety Parameters	Safety Parameters
Inventory Safety Targets	Inventory Safety Targets

PeopleSoft provides the following predefined XML documents for import data from Supply Chain Business Modeler:

XML Document	Associated Data
Purchase Order	Information for the XML document is extracted from the Supply Chain Business Modeler. Data in this document is used to establish a picture of existing purchase orders sent to the Supply Chain Business Modeler. This picture of the existing orders will be used to populate original order data in the planning instance tables and also be used to identify orders that will be marked as canceled as a result of the optimized plan. Any order sent into the Supply Chain Business Modeler but not received back on a purchase order recommendation out of the Supply Chain Business Modeler will assumed to be canceled.
Transfer Orders	Information for the XML document is extracted from the Supply Chain Business Modeler. Data in this document is used to establish a picture of existing transfer orders sent to the Supply Chain Business Modeler. This picture of the existing orders will be used to populate original order data in the planning instance and also identify orders that will be marked as canceled as a result of the optimized plan. Any order sent into the Supply Chain Business Modeler but not received back on a net deployment out of the Supply Chain Business Modeler will assumed to be canceled.

<i>XML Document</i>	<i>Associated Data</i>
Work Orders	Information for the XML document is extracted from the Supply Chain Business Modeler. Data in this document is used to establish a picture of existing production orders sent to the Supply Chain Business Modeler. This picture of the existing orders will be used to populate original order data in the planning instance and also identify orders that will be marked as canceled as a result of the optimized plan. Any order sent into the Supply Chain Business Modeler but not received back on either a net production requirement or a production schedule out of the Supply Chain Business Modeler will assumed to be canceled.
Enterprise Forecast	The Enterprise Forecast XML document contains forecast information that was generated by Demand Management (DM). Only inventoried items are sent to the Supply Chain Business Modeler as a part of the standard integration so it is assumed that only Inventory Item forecast will be received out of the Supply Chain Business Modeler.
Net Deployment Requirements	The Net Deployment Requirements XML document contains information about inventory transfers between two business units and represents results out of the Production and Distribution Planning (PDP). Details for net deployments may contain data for existing transfers as well as new inter unit transfer requirements.
Net Production Requirements	The Net Production Requirements XML document contains information about production requirements for an item at a given branch and represents the results out of the Production and Distribution Planning (PDP). Details for net production requirements may contain data for existing production as well as new production requirements.
Production Schedules	The Production Schedule XML document contains detailed production information including specific operations, resources, and material to use in the manufacturing process. Production schedule information can be produced by Production and Distribution Planning and production schedule information can also be produced by Production Scheduling (PS) and Production Scheduling Process (PSP). Production Schedules may contain both existing and new production.

<i>XML Document</i>	<i>Associated Data</i>
Purchase Order Recommendations	The purchase order recommendations XML document contains information regarding purchases that need to be made based on predefined supplier/item relationships. Purchase order recommendations can be produced by Production and Distribution Planning. The information may contain both new and existing purchase orders.

Exporting Data to Supply Chain Business Modeler

This section discusses how to export data to Supply Chain Business Modeler.

Page Used to Export Data to Supply Chain Business Modeler

<i>Page Name</i>	<i>Definition Name</i>	<i>Usage</i>
<u>Export data to SCBM Page</u>	APS_OUT_RUN	Initiate the Export data to SCBM - Single Application Engine process (APS_O_MAIN) or initiate the Export data to SCBM - Multi Application Engine process (APS_OUT). Both of these processes export the XML documents from PeopleSoft Supply Chain Management to the Supply Chain Business Modeler. The Export Data to SCBM - Single process runs the XML documents serially where as the Export Data to SCBM - Multi process allows for the XML documents to be generated in parallel and can take advantage of multiple CPU environments.

Export data to SCBM Page

Use the Export data to SCBM page (APS_OUT_RUN) to initiate the Export data to SCBM - Single Application Engine process (APS_O_MAIN) or initiate the Export data to SCBM - Multi Application Engine process (APS_OUT).

Both of these processes export the XML documents from PeopleSoft Supply Chain Management to the Supply Chain Business Modeler. The Export Data to SCBM - Single process runs the XML documents serially where as the Export Data to SCBM - Multi process allows for the XML documents to be generated in parallel and can take advantage of multiple CPU environments.

Navigation:

SCM Integrations > Advanced Planning > Export data to SCBM

This example illustrates the fields and controls on the Export data to SCBM page. You can find definitions for the fields and controls later on this page.

Fences

Field or Control	Description
Current Option	Select how you want to specify the current date. You can enter a specific date or an offset in days from the system date. Values are: <ul style="list-style-type: none"> • <i>Date</i> • <i>Offset</i>
Current Date	Select the current date. This field is available if you select <i>Date</i> as the Current Option.
Current Offset	Enter the current offset in days. This field is available if you select <i>Offset</i> as the Current Option.
Start	Enter the start fence in days from the current time. This value can be negative and the start fence must be less than or equal to the current time.
End	Enter the end fence in days from the current time. This value can be negative and the end fence must be greater than the current time.

Field or Control	Description
History Start	<p>Enter the history start fence in days from the current time. This value can be negative and the history start fence must be less than current time.</p> <p>The system will only use the history start fence when selecting data for the Sales Order History XML Document.</p>

Filters



Field or Control	Description
Item SetID	Select the item SetID for the data that you would like to export to Supply Chain Business Modeler.
Include Quotes	Select this check box if you want to include quotes in the data that is passed to the Supply Chain Business Modeler.
Quote % (quote percentage)	If you select to include quotes, then enter the quote percentage to include. Quotes with an acceptance percentage equal to or greater than the value entered will be included in the data sent to the Supply Chain Business Modeler.
Reverse Quarantine Qty (reverse quarantine quantity)	Select this check box if you want to reverse the quarantine quantity from the quantity on hand that is sent to the Supply Chain Business Modeler using the Base XML document.

Global Defaults

Field or Control	Description
Base Currency	Select a base currency. This currency and rate are used for formatting costs and prices into a common currency within Supply Chain Business Modeler.
Rate Type	Select a rate type. This currency and rate are used for formatting costs and prices into a common currency within Supply Chain Business Modeler.

Field or Control	Description
Constrained Time Fence	Enter a constrained time fence in number of days. This value must be greater than or equal to zero. The Base XML Document uses this value to populate the constrained item fence value directly on the Item Branch attribute.
Fixed Production Fence	Enter a fixed production fence in number of days. This value must be greater than or equal to zero. The Base XML Document uses this value to populate the fixed production fence attribute on machines, crews, and tools directly.
Item Group Option	Select how you want to control formatting of the item group within Supply Chain Business Modeler. Values are: <ul style="list-style-type: none"> • <i>Family</i>: Item Family • <i>Group</i>: Item Group

Model Documents

Field or Control	Description
Configuration, Calendar, Base, Distribution, Supplier, Customer, Manufacturing, Forecasts, Sales Orders, Sales Order History, Transfer Orders, Beginning Inventory, Work Orders, Purchase Orders, and Safety Parameters	Select the check box next to each of the different types of XML documents that you want to have created and exported to the Supply Chain Business Modeler.
	Click the Select All button to select all of the XML Documents at once.
	Click the Clear All button to clear the selection of any XML Documents.
Write Export Files To	Enter the output directory, folder, or URL for the exported XML Documents.

Importing Data From Supply Chain Business Modeler

This section discusses how to import data from Supply Chain Business Modeler.

Page Used to Import Data From Supply Chain Business Modeler

<i>Page Name</i>	<i>Definition Name</i>	<i>Usage</i>
<u>Import data from SCBM Page</u>	APS_IN_RUN	Initiate the Import data from SCBM - Single Application Engine process (APS_I_MAIN) or initiate the Import data from SCBM - Multi Application Engine process (APS_IN). Both of these processes import the XML documents from the Supply Chain Business Modeler to PeopleSoft Supply Chain Management. The Import data from SCBM - Single process runs the XML documents serially where as the Import data from SCBM - Multi process allows for the XML documents to be generated in parallel and can take advantage of multiple CPU environments.

Import data from SCBM Page

Use the Import data from SCBM page (APS_IN_RUN) to initiate the Import data from SCBM - Single Application Engine process (APS_I_MAIN) or initiate the Import data from SCBM - Multi Application Engine process (APS_IN).

Both of these processes import the XML documents from the Supply Chain Business Modeler to PeopleSoft Supply Chain Management. The Import data from SCBM - Single process runs the XML documents serially where as the Import data from SCBM - Multi process allows for the XML documents to be generated in parallel and can take advantage of multiple CPU environments.

Navigation:

SCM Integrations > Advanced Planning > Import data from SCBM

This example illustrates the fields and controls on the Import data from SCBM page. You can find definitions for the fields and controls later on this page.

Field or Control	Description
Published Forecast	Select this check box if you want to update published forecast planning data to PeopleSoft Supply Chain Management.
Planning Instance, Planning Instance	Select this check box if you want to update a particular planning instance of planning data to PeopleSoft Supply Chain Management. Then enter the planning instance in the Planning Instance field.
Net Deployment Requirements	If you select to update by planning instance, then select this check box if you want to import net deployment requirements.
Net Production Requirements	If you select to update by planning instance, then select this check box if you want to import net production requirements.
Purchase Order Recommendations	If you select to update by planning instance, then select this check box if you want to import purchase order recommendations.
Production Schedule	If you select to update by planning instance, then select this check box if you want to import the production schedule.
Import Files From	Enter the location of the XML documents that you want to import.

Integrating with Oracle's Demantra Demand Management

Understanding Demantra Integration

This section discusses:

- PeopleSoft Advanced Planning - Demantra processes.
- Information flow between PeopleSoft and Demantra Demand Management.

Oracle's Demantra Demand Management Integration, enables you to use the Demantra Demand Management system in conjunction with PeopleSoft's demand history data, Inventory, Supply Planning, and Inventory Policy Planning. Demantra Demand Management is a configurable, web-based product that helps an organization perform demand planning and forecasting. The product provides access to historical and other reference data.

Using the Advanced Planning, Demantra component, you can manage the integration of data between PeopleSoft and Demantra Demand Management. You can establish and maintain demand history data and export this data to the Demantra planning system using an Oracle Process Integration Package (PIP). The system can then generate forecasts using the Demantra Demand Management application and its forecasting calculations. After forecasts have been generated in Demantra, you can:

1. Export the forecast from Demantra to a flat file using the Process Integration Package.
2. Import the forecast flat file back into PeopleSoft using the Import Forecast component.

After the forecasts have been imported into PeopleSoft they are then available for use by other PeopleSoft applications.

This topic only provides details about the PeopleSoft Supply Chain Management Integrations component. For more information about using integration processes and programs, review these documents.

- Oracle Application Integration Architecture Release 1.0, *Oracle Value Chain Planning Integration to JD Edwards Implementation Guide*.
- Oracle Application Integration Architecture Release 1.0, *Oracle Value Chain Planning Integration to JD Edwards Installation Guide*.
- Oracle Application Integration Architecture Release 1.0, *Oracle Value Chain Planning Integration to JD Edwards Release Notes*.

PeopleSoft Advanced Planning - Demantra Processes

The setup and processing of data to be exported to and imported from Demantra Demand Management is accomplished using the Advanced Planning - Demantra component. Using the component you:

- Create calendars and weight profiles.

You use calendars and weight profiles to define different period buckets and weights for each day and are passed to Demantra using the Process Integration Package.

See [Setting Up Calendar and Weight Profiles](#).

- Create a map ID that maps PeopleSoft fields to Demantra integration file fields.

This map is used to define which data is passed from PeopleSoft to Demantra Demand Management for use in forecast generation.

See [Mapping PeopleSoft Fields To Demantra Fields](#).

- Build demand history from PeopleSoft application internal data.

Internal data is transactional data that consists of demand quantities, dates, costing information, and attributes that are related to the product, item, location, and customers and so on.

See [Building and Reviewing Demand History](#).

- Create specifications and run controls to export PeopleSoft data to Demantra Demand Management.

See [Exporting Data to Demantra](#).

- Create specifications and run controls to import forecast data from Demantra Demand Management.

This data is used to publish forecast information and populate existing publish tables for PeopleSoft applications.

See [Importing Data from Demantra](#).

- Review imported forecast information.

See [Reviewing and Updating Imported Forecasts](#).

Information Flow Between PeopleSoft and Demantra

To support the use of the Demantra Demand Management application, system administrators need to install the application and users must be familiar with the application's setup and use.

The Oracle Process Integration Package also needs to be installed, setup, and configured and users must be familiar with this as details are not provided by PeopleSoft.

The example illustrates the processing steps required to integrate PeopleSoft with Demantra Demand Management:

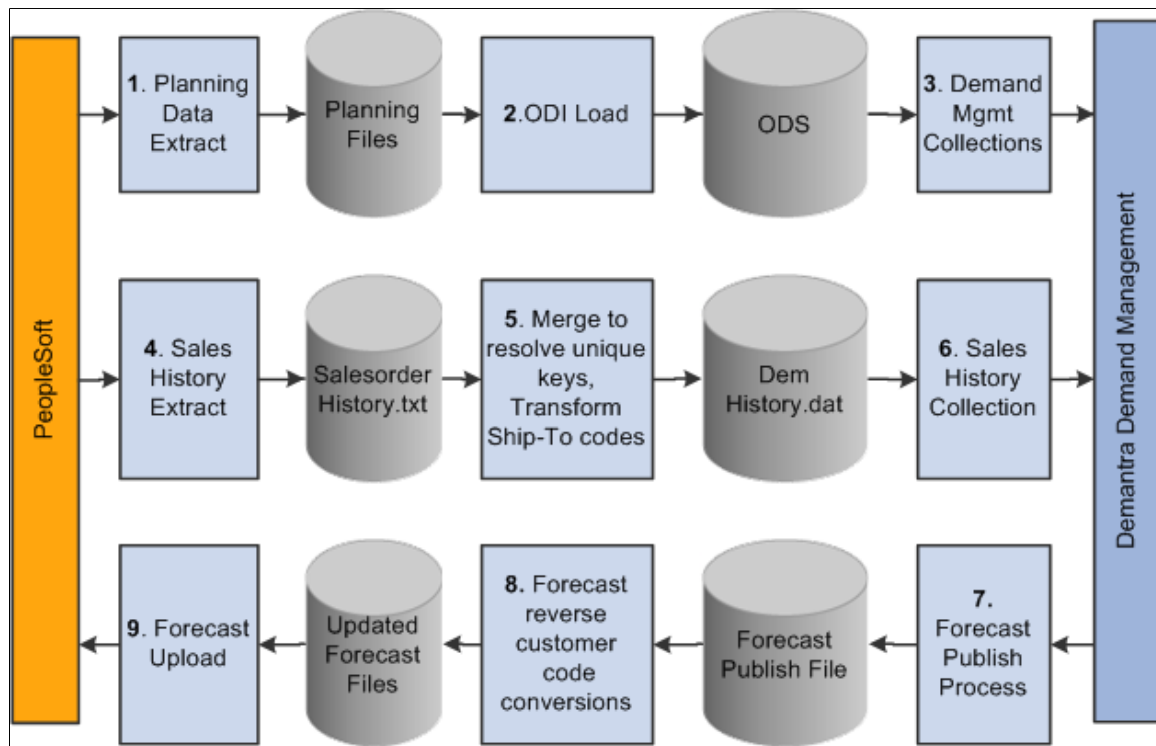

The process for exchanging files between PeopleSoft and Demantra Demand Management includes:

1. Extracting planning data.

This is performed in PeopleSoft using the Base, Customer, and Calendar Export options. The system uses data in the demand history to populate the base.xml, customer.xml and calendar.txt files that are required by the Process Integration Package.

2. Loading data into the Oracle Data Integrator (ODI).

The system processes base, customer, and calendar files and loads data into ODI using the Process Integration Package.

3. Collecting demand management item, organization, and customer data

The data is loaded from the Operational Data Store (ODS) into Demantra using the Process Integration Package.

4. Extracting sales history.

Using the Sales Export option in PeopleSoft, the system extracts sales history data from the demand history to populate the SalesOrderHistory.txt file.

5. Merging and resolving unique keys and transforming ship-to codes.

The Process Integration Package processes the SalesOrderHistory file together with data already loaded into the ODS, and uses it to generate a file of demand history called DemHistory.dat.

6. Collecting sales history.

The PIP processes the DemHistory file and loads the data into Demantra Demand Management.

7. Exporting forecast publish process data is from Demantra Demand Management using the PIP.
8. Converting the forecast and reverse the customer code.

The PIP processes the exported forecast data to generate a file of forecast details called forecast.txt.

9. Uploading the forecast.

The forecast.txt file is imported into PeopleSoft and used to populate the publish tables that will be ready for use by PeopleSoft Supply Planning, Inventory Policy Planning and Inventory applications.

Common Elements Used in Demantra

<i>Field or Control</i>	<i>Description</i>
Item/Product Forecasts	Select a value that determines the nature of the forecast. If you select Item , the system sets the Item Code field to <i>INV_ITEM_ID</i> and the Organization field to <i>BUSINESS_UNIT_IN</i> . If you select <i>Product</i> the system sets the Item Code field to <i>PRODUCT_ID</i> and the Organization field to <i>BUSINESS_UNIT_OM</i> .
Publish Name	Enter or select a label that other applications use to identify the publish activity. The name is a logical name that you can use to publish a forecast again and again. When you import forecasts, you can select which name you want to use to populate publish forecast tables. The system uses this field, along with a forecast publish date, to create a unique publish instance that other applications use to retrieve the published data.
Map ID	Select or enter a map ID. You use map IDs to map data fields from PeopleSoft to Demantra Demand Management flat files. During the demand export and forecast import processes, the system uses the map ID to identify what data to export and to validate the data that is being imported.

Setting Up Calendar and Weight Profiles

This section provides an overview of calendars and discusses how to define calendar patterns, create and maintain calendars, and define calendar periods.

Pages Used to Set Up Calendar and Weight Profiles

<i>Page Name</i>	<i>Definition Name</i>	<i>Usage</i>
<u>Defining Calendar Patterns Page</u>	DP_CALENDARPATTERN	Define calendar patterns.
<u>Define Calendar Structure Page</u>	DP_CALENDARS	Create and maintain calendars.
<u>Periods Page</u>	DP_CALENDARS_2	Define calendar periods.
<u>Calendar Weight Profiles Page</u>	DP_WEIGHTPROFILES	Define calendar weight profiles that include assigning a pattern code and start and end dates to a calendar.
<u>Change Calendar Weights Page</u>	DP_CALENDARWGTS	Change daily calendar weights for a specific calendar.
Copy Weight Profile Page	DP_COPYWTPROFILE	Create weight profiles for a new or existing calendar by using profiles from an existing calendar.

Understanding Calendars

A calendar in PeopleSoft controls forecast and inventory policy parameters for each day of the year by using weights. The system stores weights for each day and distributes raw data into different period buckets based on the weights.

Note: Some calendar attributes are used by PeopleSoft Inventory Policy Planning and not in conjunction with Demantra Demand Management integration.

Here are some key factors for working with calendars:

- Establish an overall time frame that might extend over several years.

A calendar should start at a date that is equal to or prior to the earliest date of the demand history that you want the application to populate and recognize. The calendar should extend beyond the end of the forecast horizon.

Set up a standard calendar which includes the generally observed corporate holidays or vacations. You can then copy this calendar to other calendars as a starting point when setting up calendars to reflect local operating conditions.

- Define multiple calendars that cover the same date ranges.
- Change days within a specific calendar to contain various elements of data.

Calendar patterns are week-long templates that you use to maintain calendar weights for each day in a weight profile. The week is from Monday through Sunday. Use patterns to set up daily weights attributes quickly for calendar weight profiles and apply them to a range of dates within the weight profile.

Weight profiles are templates that you use to create and maintain daily weights. The default weight profile typically has a normal weight distribution across a given date range.

Here are some examples of weight profiles that can be set up for customer ordering patterns:

- Orders are placed on the 1st and the 15th of the month.
- Orders are placed toward the end of the month.
- Orders are placed toward the end of the quarter.

Periods define time buckets for a calendar. Each calendar period is numbered within a year, either based on a calendar or fiscal year, and has a start date and an end date.

The definitions also allow the system to associate fiscal years and periods with underlying calendars, based on calendar years. For example, suppose that an organization's fiscal year runs from July to June on a monthly basis and you associate month one with July. The calendar period definition runs from July 1 of the starting year to June 30 of the ending year. In turn, the definition associates period one in each fiscal year with the month of July.

You cannot overlap start and end dates within a single period definition. However, the same day can belong to a different period in another period definition. The period definitions are independent of the daily weight attributes and therefore, the same day within the same calendar has identical attributes even if it is contained in multiple period definitions.

Note: When deciding whether to base period definitions on calendar or fiscal years, consider which period that forecasters and collaborators consider as period one. When the forecast is published for use by PeopleSoft Inventory Policy Planning, Supply Planning or Inventory, the system uses dates to determine the period to which the forecast is assigned.

The system copies the data setup for a pattern code to the appropriate day in the weight profile. You can apply different pattern codes for different date ranges to change daily attributes or weightings for days that are in a selected date range. The pattern code is not stored in the weight profile; rather, the system copies attributes from the pattern code to each day in the weight profile. Therefore, you can reapply the pattern-code data to parts of the weight profile at any time.

You can also:

- Create new pattern codes and apply them to weight profiles that are already in use.
- Assign pattern codes to weight profiles by using the Weight Profiles page. To access the page, select **Define Calendars > Weight Profiles**.
- Change details for an existing pattern code at any time.

This does not change the details on a weight profile where the pattern code has been used. To change the weight profile details, you must maintain the individual weight profile by reapplying the new pattern code to it or by changing the weight details manually on the weight profile.

Defining Calendar Patterns Page

Use the Define Calendar Patterns page (DP_CALENDARPATTERN) to define calendar patterns.

Navigation:

SCM Integrations > Advanced Planning > Demantra > Calendar Patterns

<i>Field or Control</i>	<i>Description</i>
Pattern Code	Enter a code for use when you apply the pattern to a period of data. You assign pattern codes to weight profiles by using the Weight Profiles page. You can add a new calendar pattern at any time, and you must define at least one calendar pattern before you add a new weight profile.
Demand Weight	Enter the relative weight for each day. For Demantra integration, the demand weight is used to determine whether a day is a working or a nonworking day when the system creates the calendar flat file.

Define Calendar Structure Page

Use the Define Calendar Structure page (DP_CALENDARS) to create and maintain calendars.

Navigation:

SCM Integrations > Advanced Planning > Demantra > Calendars

<i>Field or Control</i>	<i>Description</i>
Calendar ID	Enter a code for identifying the calendar. This field is required.
Start Date	Enter a date that is early enough to cover the entire period of historical data that you plan to use in the system. The date is required and cannot be changed after you save the calendar.
End Date	Enter a date that is far enough in the future to cover all future planning periods. PeopleSoft recommends that you start and end the overall calendar on the first and last day of a year even if the organization's fiscal year is different. The system requires the date and can extend it during the life of the calendar.

Periods Page

Use the Periods page (DP_CALENDARS_2) to define calendar periods.

Navigation:

SCM Integrations > Advanced Planning > Demantra > Calendars

Select the Periods tab.

You can define multiple period codes for a calendar along with varying date ranges that increase the flexibility of the calendar. To create calendar periods:

1. If you are creating additional periods, click the **Add Row** button.

If this is the first time that calendar periods are added for the calendar, you do not need to perform this step.

2. Enter the period code that you want to use for the calendar, and a description.
3. Select a period type that determines which periods per year the calendar uses.

The system inserts the default value for the selected period type in the **Periods Per Year** field. You can override that value; however, if you want to customize the periods per year, select the *Periodic* period type.

If you previously added a period code, the system enters default values in the **Start Date**, **End Date**, and **Forecast Period/Year** start and end fields. You can override these values as needed.

4. Enter a start date and end date to set up the date range for the period code.

The system provides a default start and end date from the calendar. Values are required for both fields.

5. Enter values in the **Forecast Period/Year** fields for the start and end date to define a starting period other than the system default.

Use this feature to distinguish between a yearly calendar and a fiscal calendar. Yearly calendars match the start date, but you offset the date by entering the period that matches the start of the fiscal year. Values are required for both fields. If you are setting up weekly periods codes, you must indicate what week is the first week of the year.

6. Click the **Recreate** button.

If this is the first time that periods are defined for the calendar, click the **Create** button.

The system populates the lower portion of the page with more detailed period information.

You can change the details for an existing period definition at any time; however, you cannot change all of the fields. To change the period type or the starting date or starting period year, you must delete the period definition and recreate it. You can change the end date, end period, and year, as well as any of the individual period start and end dates.

The system can re-create period date ranges automatically. This process deletes existing period data and creates new periods and ranges that are based on the date and period details that you provide. If you need to extend the period definition end date, select a new end date, period and year; then click the **Extend** button to create new periods at the end of the existing periods, extending the periods through to the new end date.

Field or Control	Description
Period Code	Enter a unique code that the system uses to retrieve data that you define for this period definition. Periods cannot overlap or have gaps between them. Within a single definition, you must include each day in a period, and a day cannot belong to more than one period.

Field or Control	Description
Period Type	<p>Select a value that determines the type of periods that make up the calendar. The formats for all period types are recurring through the end date for the calendar. The field is required.</p> <p>Values include:</p> <ul style="list-style-type: none"> • <i>4 WEEKLY</i>: Each period is made up of four weeks. Use this in situations when you want to use a 13-month calendar. • <i>445</i>: The first two periods are four weeks long and the third is five weeks long. • <i>454</i>: The first and last periods are four weeks and the second period is five weeks. • <i>544</i>: The first period is five weeks and last two are four weeks. Each of the 4-4-5 period types are the same. The only difference is to indicate which month begins the 4-4-5 cycle. • If the first month that you define in the calendar is the second month of the 4-4-5 cycle, select the 4-5-4 period type. If the first month that you defined in the calendar is the five-week month, select the 5-4-4 period type. • <i>MONTHLY</i>: Each period represents a calendar month. • <i>PERIODIC</i>: The number of periods in a year is the value that you enter in the Periods Per Year field. • <i>QUARTER</i>: Each period is three months long. • <i>WEEKLY</i>: Each period is seven days long.
Periods Per Year	<p>Enter the number of periods that occur in one year for the period type that you selected. The system provides a default value that is based on the period type that you select.</p>
Total Periods	<p>Displays the total number of periods in the calendar horizon when periods are created.</p>

Field or Control	Description
Start Date and End Date calendar start and end dates	<p>Enter a start and end date to define a subset of periods within the calendar, or change the start date to match the period one start date. The start and end dates must be within or equal to the start and end dates that you define on the Calendars page.</p> <hr/> <p>Note: When adding weekly periods based on a calendar year, make sure that the start date is at the beginning of the week that you want to have as week one. For example, suppose that the week runs from Sunday to Saturday and January 1 is a Friday. Set the start date to January 3 and include the prior two days in the last period of the previous year. Refer to the ISO 8601 (International Standards Organization) standard for determining the first week of the year. Also, the ISO calendar standards indicate which years have 52 weeks (short ISO calendar year) and which years have 53 weeks (long ISO calendar years). For example, 1998, 2004, and 2009 might be within the calendar horizon and if you are establishing weekly periods. Then you should refer to the ISO standard to determine the beginning dates for the weeks in those years.</p>

This table lists actions if the monthly period type is based on a calendar year or a fiscal year:

Calendar Type	Start Date	Period Action	Year Action
Calendar Year	1/1/2003	The system uses the default value of 1 as the start period.	The system uses the default value of 2003 as the year.
Calendar Year	7/1/2003	The system uses the default value of 7 as the start period.	The system uses the default value of 2003 as the year.
Fiscal Year: July 1-June 30	1/1/2003	You must enter 7 (January) as the forecast period to show the middle of the fiscal year.	You must enter 2003 as the fiscal year for the forecast.
Fiscal Year: July 1-June 30	7/1/2003	You must enter 1 as the forecast period to show the start of the fiscal year.	You must enter 2004 as the fiscal year for the forecast.

After you are enter data and re-create it, review the record of periods to enter any changes that you want to make to the start and end dates. If you change an end date, the system automatically updates the next start date. If you change a start date, the system automatically adjusts the previous end date. If there are insufficient days between the start and end date or too many days to split into periods, an error message appears.

<i>Field or Control</i>	<i>Description</i>
Forecast Period/Year	The system populates these start and end values based on the information that you enter in the Start Date and End Date fields. Enter either a forecast period, a year, or both to create or maintain the start and end date of the calendar manually.
Recreate	Click to rebuild period definitions if you change the forecast date, period, or year.
Extend	Click if you want the system to calculate the start and end period dates automatically for the period of time that you add. This increases the time over which the period code is valid by extending the end date. Note: If you click the Extend button, you must recalculate the trading days to populate the trading days value for those extended periods.

Calendar Weight Profiles Page

Use the Calendar Weight Profiles page (DP_WEIGHTPROFILES) to define calendar weight profiles that include assigning a pattern code and start and end dates to a calendar.

Navigation:

SCM Integrations > Advanced Planning > Demantra > Weight Profiles

The **Calendar ID** and **Year** fields are display-only. You can change the month field and enter data in each of the daily boxes. You must create a weight profile for each calendar. The system requires that you have a weight profile for the calendar that is associated with a forecast that is designated as the default weight profile.

<i>Field or Control</i>	<i>Description</i>
Calculate Trading Days	Select this option to indicate that the system should use this weight profile to calculate trading days. If you select to calculate trading days, then when you maintain calendar period information, you can also view the total number of trading days for each period. Use the Periods page to view the number of trading days. Note: This feature is not used with the Demantra integration.

Field or Control	Description
Pattern Code	<p>Select a pattern code. When you set up a new weight profile, you can add the daily weights automatically by using one or more pattern codes. This is the easiest way to create the basic daily data for the weight profile for the first time. After this, you can change some or all of the daily weights by using another pattern code or by changing the weights for a single day.</p> <hr/> <p>Note: It is not necessary to apply the pattern code to the entire weight profile before saving it. Provided the weight profile has a start and end date, you can save it without applying a pattern and then subsequently apply the pattern code for ranges of dates within the weight profile start and end dates as required.</p> <hr/>
Start Date	Select a date from which you want to apply the pattern along with an end date. You can repeat this to apply different patterns to different date ranges within the calendar.
End Date	Select a date on which you want to finish applying the pattern.

Change Calendar Weights Page

Use the Change Calendar Weights page (DP_CALENDARWGTS) to change daily calendar weights for a specific calendar.

Navigation:

SCM Integrations > Advanced Planning > Demantra > Change Calendar Weights

This example illustrates the fields and controls on the Change Calendar Weights page. You can find definitions for the fields and controls later on this page.

Change Calendar Weights

Calendar ID **DEFAULT**

Default Calendar

Weight Profile **TESTINGUNIT**

Testing Unit

⏪ ⏩
*Month
*Year
Refresh
⏪ ⏩

Daily Weights						
Monday	Tuesday	Wednesday	Thursday	Friday	Saturday	Sunday
					1	2
					<input type="text"/>	<input type="text"/>
3	4	5	6	7	8	9
<input type="text" value="1"/>	<input type="text" value="1"/>	<input type="text" value="1"/>	<input type="text" value="1"/>	<input type="text" value="1"/>	<input type="text"/>	<input type="text"/>
10	11	12	13	14	15	16
<input type="text" value="1"/>	<input type="text" value="1"/>	<input type="text" value="1"/>	<input type="text" value="1"/>	<input type="text" value="1"/>	<input type="text"/>	<input type="text"/>
17	18	19	20	21	22	23
<input type="text" value="1"/>	<input type="text" value="1"/>	<input type="text" value="1"/>	<input type="text" value="1"/>	<input type="text" value="1"/>	<input type="text"/>	<input type="text"/>
24	25	26	27	28	29	30
<input type="text" value="1"/>	<input type="text" value="1"/>	<input type="text" value="1"/>	<input type="text" value="1"/>	<input type="text" value="1"/>	<input type="text"/>	<input type="text"/>
31						
<input type="text" value="1"/>						

A daily calendar displays each day along with any weights for the day. Use the calendar to adjust the daily weight attribute by entering the relative demand weight for the day.

See [Setting Up Calendar and Weight Profiles](#).

Mapping PeopleSoft Fields To Demantra Fields

You can map PeopleSoft fields for use with Demantra Demand Management processing. The system provides a field where you can indicate whether the map is at the product or item level. This section discusses how to map base fields, map customer fields, and map sales fields.

Pages Used to Map and Maintain Forecasting Fields

<i>Page Name</i>	<i>Definition Name</i>	<i>Usage</i>
Define Field Mappings - Base Page	FINT_ITMFLDMAP	Define base field mappings.

Page Name	Definition Name	Usage
<u>Define Field Mapping - Customers Page</u>	FINT_LOCFLDMAP	Define customer field mappings.
<u>Define Field Mappings - Sales Page</u>	FINT_SALEFLDMAP	Define sales field mappings.
Copy Field Mappings Page	FINT_COPY_FLD_MAP	Copy a map ID to create a new map.
Delete Field Mappings Page	FINT_DEL_FIELDMAPS	Delete a map ID.

Define Field Mappings - Base Page

Use the Define Field Mappings - Base page (FINT_ITMFLDMAP) to define base field mappings.

Navigation:

SCM Integrations > Advanced Planning > Demantra > Define Field Mappings

This example illustrates the fields and controls on the Define Field Mappings - Base page. You can find definitions for the fields and controls later on this page.

Use this page to define which PeopleSoft fields are mapped to Demantra fields contained in the integration Base.xml file. You must select a value in the Item/Product Forecasts field. The page consists of a number of mapping fields along with a single Item Group Mappings grid used for mapping additional fields to Demantra using the Custom Hook functionality provided by the integration. For a new mapping, the system provides default values for field mappings.

Note: When you are using the Item Group Mappings grid, the group name that you enter cannot match the category name. Group names must be unique and cannot be duplicated, but you can map the same planning field mapped to more than one group.

Field or Control	Description
Map Name	Enter a name that you want to use to describe the map ID. See Common Elements Used in Demantra
Item Code	If the Item/Product Forecasts field value is <i>Item</i> , then the system sets the Item Code field to <i>INV_ITEM_ID</i> . The field cannot be changed. If the Item/Product Forecasts field value is <i>Product</i> , the Item Code field is set to <i>PRODUCT_ID</i> and cannot be changed. You cannot leave the Item/Product Forecasts field blank.
DM_ITEM_DESC	Displays a value based on the Item/Product Forecasts field setting. When the setting is <i>Item</i> , this field displays <i>MITBL_DESCR</i> . When the setting is <i>Product</i> , this field displays <i>PRDITM_DESCR</i> .
Organization	The field is set to <i>BUSINESS_UNIT_IN</i> if the Item/Product Forecast field is set to <i>Item</i> . The Organization field is set to <i>BUSINESS_UNIT_IN</i> when the Item/Product Forecast field value is <i>Product</i> .
DM_ORG_DESC	Displays the description – <i>DESC</i> and is used to pass the description for the business unit to the integration.
Master Branch	Select a master branch. The master branch is required by the integration for validation purposes but the value is not used by Demantra. The master branch populates the base.xml file so that the branch will have an entry for each item or product, whether that branch and item combination exists in reality.
Product Family	Select a product family for the map ID. The system uses the data in this field to populate the product family in Demantra.
Planning UOM (planning unit of measure)	Displays the unit of measure to be mapped to the planning unit of measure in the integration. You cannot change the value.
Shipping UOM (shipping unit of measure)	Select the shipping unit of measure for this map ID. The shipping unit can be the shipping, standard, volume, or weight unit of measure.
Primary UOM (primary unit of measure)	Select a primary unit of measure to be used with this map ID. The primary unit can be the shipping, standard, volume, or weight unit of measure.

Field or Control	Description
Volume UOM (volume unit of measure)	Displays a volume unit of measure to be used with this map ID. You cannot change the value.
Weight UOM (weight unit of measure)	Displays a weight unit of measure to be used with this map ID. You cannot change the value.

Branch Category Parameters

Branch categories are populated as default values and cannot be changed.

Field or Control	Description
Operating Unit	Displays the PeopleSoft field used to populate the operating unit in Demantra. The GL_BUS_UNIT is obtained from the BUS_UNIT_TBL_GL table for the business unit that is being processed.
Business Group	Displays the PeopleSoft field – GL_BUS_UNIT– used to populate the business unit in Demantra.
Legal Entity	Displays the PeopleSoft field – LEGAL_ENTITY– that is used to populate the legal entity in Demantra.

Item Default Category

The item default category in Demantra is populated with the PeopleSoft field that you select in the **Planning Field** field.

Field or Control	Description
Category Name	Displays the item default category name.
Planning Field	Select a planning field to be used to populate the item default category.

Item Group Mappings

The system uses item group mappings to populate additional fields in Demantra using the Customer Hooks functionality provided through the integration.

Field or Control	Description
Group Name	Enter a name for the item group mapping that you will create using this grid. The group name is required by the integration. The name cannot match the item default category name. The group name cannot be duplicated; however, you can duplicate the PeopleSoft planning field to which the name is mapped.
Planning Field	Select a PeopleSoft planning field with which you want to populate the group name that you entered.

Define Field Mapping - Customers Page

Use the Define Field Mapping - Customers page (FINT_LOCFLDMAP) to define customer field mappings.

Navigation:

Click the Customers tab on the Define Field Mapping - Base page.

This example illustrates the fields and controls on the Define Field Mappings - Customer page. You can find definitions for the fields and controls later on this page.

Use this page to define which PeopleSoft fields are mapped to Demantra fields contained in the integration Customer.xml file. You must select a value in the **Item/Product Forecasts** field. The page consists of a number of mapping fields along with a single Customer Group Mappings grid used for mapping additional fields to Demantra using the Custom Hook functionality provided by the integration. For a new mapping, the system provides default values.

The **Site Code** field is set to the Ship to Cust ID and you cannot change the value.

Note: When you are using the Customer Group Mappings grid, the group name that you enter cannot match either the channel name or the demand class name. Group names must be unique and cannot be duplicated but you can map can use the same planning field mapped to more than one group.

The channel and demand class in Demantra are populated with the PeopleSoft values that you select for the **Channel Planning Field** and **Class Planning Field** fields.

The channel name and demand class name are required by the integration.

Customer Category Parameters

<i>Field or Control</i>	<i>Description</i>
Channel Name	Enter a name for the channel. This is required by the integration.
Channel Planning Field	Select a planning field that you want to map to the Channel field in Demantra.
Demand Class Name	Enter a name for the demand class. This is required by the integration.
Class Planning Field	Select a planning field that you want to map to the Demand Class field in Demantra. See Define Field Mappings - Base Page .

Customer Group Mappings

Use this grid to map a customer group name. The system uses customer group mappings to populate additional fields in Demantra using the Customer Hooks functionality provided through the integration.

<i>Field or Control</i>	<i>Description</i>
Group Name	Enter a group name. The group name cannot match either the channel name or demand class name. The group name cannot be duplicated; however, you can duplicate the PeopleSoft planning field to which the name is mapped.
Planning Field	Select a PeopleSoft planning field to which you want to link the customer group mapping name that you entered.

Related Links

[Define Field Mappings - Base Page](#)

Define Field Mappings - Sales Page

Use the Define Field Mappings - Sales page (FINT_SALEFLDMAP) to define sales field mappings.

Navigation:

Click the Sales tab on the Define Field Mappings - Base page.

This example illustrates the fields and controls on the Define Field Mappings - Sales page. You can find definitions for the fields and controls later on this page.

Use this page to view sales field mappings for the map ID. Field mappings on this page are display only and cannot be changed,

Field or Control	Description
Item/Product Forecasts	Select whether you want to display values for either the item or product forecast. When you make a selection, the system updates values in the Field Mappings grid.
Interface Field and Planning Field	Displays the fields that the system will use to populate the SalesOrderHistory.txt file that is passed to Demantra through the integration. The Planning Field is the PeopleSoft field that you use to populate the Interface Field .

Building and Reviewing Demand History

This section provides an overview of building demand history and discusses how to build demand history and review demand data history.

Pages Used to Build and Review Demand History

Page Name	Definition Name	Usage
Building Demand History Page	FINT_DDH_XTRACT	Build demand history by defining a process run ID, extracting details, and reviewing extractions for the previous times that the process was run.

Page Name	Definition Name	Usage
<u>Reviewing Demand History Page</u>	FINT_DMDHIST_FILT	Define selection criteria for which to review demand data history.
Demand Data History Inquiry Page	FINT_DMDHIST_TBL	Review demand history built from PeopleSoft SCM data.

Understanding How to Build Demand History

Demand history is extracted from transactions in PeopleSoft Order Management, Billing, and Inventory. Internal data is transactional data that consists of demand quantities, dates, costing information, and attributes that are related to the product, item or customer.

The internal builder process creates a staging record by pulling the demand data and all of its related attributes (item/product/customer), costs, prices, and secondary information into a single record for each transaction. This data is read directly from sales orders, shipments, transfers, and invoices based on user-specified criteria. Demand data includes new demand for a selected date range and adjustments to demand for past periods.

When the system builds internal demand, you cannot make changes to demand data that's extracted from the transaction system. If the data is not correct, you should go back to the transactional system and correct it there.

Building Demand History Page

Use the Build Demand History page (FINT_DDH_XTRACT) to build demand history by defining a process run ID, extracting details, and reviewing extractions for the previous times that the process was run.

Navigation:

SCM Integrations > Advanced Planning > Demantra > Build Demand History

This example illustrates the fields and controls on the Build Demand History page. You can find definitions for the fields and controls later on this page.

Use this page to run the Build Demand History (FINT_DHBUILD) process.

Use the **Demand Source** group box to select which internal PeopleSoft transaction data that you want to extract from PeopleSoft SCM records, such as sales orders and transfers.

<i>Field or Control</i>	<i>Description</i>
Demand From	(Extract Parameters group box) Enter a starting date from which the build process should pull data. The system extracts demand history from records only for the selected transactions from this period. The default value for this field is the latest extract demand to date for the previous extraction.
Demand To	(Extract Parameters group box) Enter an ending date from which the build process should pull data. The default value for the field is the current date.
Custom Fields From	(Extract Parameters group box) Select the record from which you want to extract custom fields. You can use custom fields from PeopleSoft Inventory to update specific user-defined fields. Using this field, you determine whether the system uses custom fields from the item level or from the item/business unit level. Values include: <i>BU Items Inventory</i> (business unit items inventory): These custom fields are related to the item ID specifically as it relates to a specific business unit. <i>Master Item Table</i> : These custom fields are related to the item ID specifically across all business units.

Field or Control	Description
<p>(Extract Parameters group box) Forecast Kit Option</p>	<p>Select whether you want to run the Demand Data History Builder process using product kits. A product kit consists of a fixed set of components that are forecasted as a unit.</p> <p>Forecast kit options include:</p> <p><i>Both:</i> Select to include components and product kits in the build process. The process creates a demand record for each product kit and for each component in the product kit.</p> <p><i>Components:</i> Select to include only the components in the build process. The process creates a demand record for each component in the product kit.</p> <p><i>Product Kits:</i> Select to include only product kits in the build process. The process creates a demand record for each product kit.</p> <p>During inventory policy generation, PeopleSoft Inventory Policy Planning can react to the kits and explode product kit items into its components. The Policy Generation (DP_CALCPOLCY) process matches inventory policy items and attributes for use in the PeopleSoft Inventory system.</p> <p>See "Understanding Product Kits" (PeopleSoft Inventory).</p>

Demand Source Tab

Select the Demand Source tab.

Displays the PeopleSoft transaction data types that are selected for the run control ID that you choose on the General tab. The check boxes that you select indicate that the system will include data from that source when it runs the build process. Sources include:

Billing

Sales Orders

Order Shipments

Material Stock Requests

Transfers

Status Tab

Select the Status tab.

Field or Control	Description
Status	<p>Displays the state of the corresponding run control ID.</p> <p>Values include:</p> <p><i>Processed</i>: Indicates that the process is complete and extracts the number of rows of data that are displayed in the corresponding column.</p> <p><i>Not Processed</i>: Indicates that this extract run control has not been processed before.</p> <p><i>Errored</i>: Indicates that this process was started but not complete because of an error.</p> <p>The system locks the build process for one of these reasons:</p> <ul style="list-style-type: none"> • The load process was running. • The load process completed in error. • The build process was already running. • The build process completed with an error. • The forecast was locked for another process.
Rows Extracted	<p>Displays the number of rows of data extracted from records when this process ran. The system writes this data to the DP_DMDHISTORY record.</p>
Notes	<p>Displays system-generated messages that indicate the number of rows that were updated from each demand source.</p>

Reviewing Demand History Page

Use the Review Demand History page (FINT_DMDHIST_FILT) to define selection criteria for which to review demand data history.

Navigation:

SCM Integrations > Advanced Planning > Demantra > Review Demand History

This example illustrates the fields and controls on the Demand Data History Inquiry page. You can find definitions for the fields and controls later on this page.

Demand Data History Inquiry

[Return to Filter](#)

Demand Data History Customize | Find | View All | First 1-8 of 8

Demand | Codes | Currency | Orders | Shipments | Billing | Items | Products | Customers | Custom Item C1

Demand Source	Demand Date	Item ID	Inventory Unit	Product ID	Order Management Unit	Ship To Customer	Demand Quantity	Demand Value	Update Status	Error Comments
BI	08/11/2000	10004	US010	10004	US001	1001	20.0000	250.0000	0	
BI	08/16/2000	LT5010	US008	LT5010	US001	1001	2.0000	1584.0000	0	
BI	08/16/2000	LT5010	US008	LT5010	US001	1001	3.0000	2376.0000	0	
BI	07/06/2006	10002	US010	10002	US001	1001	200.0000	1050.0000	0	
BI	07/06/2006	10002	US010	10002	US001	1001	200.0000	2100.0000	0	
BI	07/06/2006	10002	US010	10002	US001	1001	200.0000	1050.0000	0	
BI	07/06/2006	10002	US010	10002	US001	1001	1.0000	0.0000	0	
BI	07/11/2006	10002	US010	10002	US001	1004	500.0000	11250.0000	0	

Notify

Demand

Select the Demand tab to view information about the demand. As part of the information the page displays the source and date of the demand, the quantity and value of the demand, and any errors that occurred during the build for each row of data. The demand source is where the demand originated such as a billing or a customer.

Codes

Select the Codes tab to view information about any codes associated with the demand, for example, the UOM, source code, or forecaster code.

Currency

Select the Currency tab to view information about the currency, conversion rate, cost per unit and list price for the demand.

Orders

Select the Orders tab to view information about the orders associate with the demand. This information describes, for example, the Order Management business unit, salesperson, order line and schedule line number.

Shipments

Select the Shipments tab to view information about how the demand will be shipped. This includes the ship to customer and the item's shipping date.

Billing

Select the Billing tab to view billing information for the demand. Billing information includes the customer, invoice number and date, and the Billing business unit.

Items

Select the Items tab to view a variety of demand item information. Item information ranges from component, group, family and category information to attribute information such as item type and utilization group.

Products

Select the Products tab to view product demand information including the product ID, group, brand, category and product description.

Customers

Select the Customers tab to view customer demand information. Customer demand information includes the sold to customer and corporate customer and customer group and subgroup information.

Customer and Product Custom Items

Select any custom item tab for customers and product to view tailored demand information that has been defined by the organization.

Promotional Channel

Select the Promotional Channel tab to display PeopleSoft Order Management information that is related to events. Fields include **Customer Channel**, **Classification**, **Division**, **Region**, and **Territory**.

Exporting Data to Demantra

This section provides an overview of exporting data and discusses how to define export specifications, maintain export controls, and export demand.

Pages Used to Export Data to Demantra

<i>Page Name</i>	<i>Definition Name</i>	<i>Usage</i>
<u>Defining Export Specifications Page</u>	FINT_EXP_SPEC	Define export specifications by setting up parameters for extracting demand data into files for integration to Demantra Demand Management.
<u>Maintaining Export Controls Page</u>	FINT_DDH_CONTROL	Maintain export controls that define how the system should process demand data history.

Page Name	Definition Name	Usage
<u>Export Demand Page</u>	FINT_EXPORTDMD	Export demand to Demantra Demand Management.
Copy Export Specifications Page	DP_COPYDPINT_SPECS	Create an export specification by copying the attributes of an existing specification. The system copies the specification parameters and the selection criteria from the specification.
Delete Export Specifications Page	DP_COPYDPINT_SPECS	Delete export specifications.

Understanding Data Export

Demand data is the actual sales requirement for a product, item, or component. When defining an import specification for demand data, select the data fields that you want the system to use for importing demand data. When you load records, the system processes demand data that matches the selection criteria that you define on this page. You can also define additional parameters or update these parameters when you run the import process.

When you use this specification to load data, the system processes items only in the forecast that you select.

Defining Export Specifications Page

Use the Define Export Specifications page (FINT_EXP_SPEC) to define export specifications by setting up parameters for extracting demand data into files for integration to Demantra Demand Management.

Navigation:

SCM Integrations > Advanced Planning > Demantra > Define Export Specifications

This example illustrates the fields and controls on the Define Export Specification. You can find definitions for the fields and controls later on this page.

Use this page to define basic information about an export specification, select demand sources, and define selection criteria. Export specifications enable you define a set of data that you can export for use with the Oracle Value Chain Planning Process Integration Package (PIP).

Field or Control	Description
Date Updated	Displays the last date the export specification was updated.
Updated By	Displays who updated the export specification.
Posting UOM (posting unit of measure)	Displays <i>Standard Inventory UOM</i> which indicates that the system uses the unit of measure defined for the item at the business unit level. Values are only retrieved for weight and volume.
Delimiter	Select the delimiter that the system uses during the integration Values include: <ul style="list-style-type: none"> • + (plus sign). • -(minus sign). • .(period). • / (forward slash). • \ (backward slash). • (slash).

Field or Control	Description
Forecast Kit Option	<p>Select whether you want to run the process using product kits. A product kit consists of a fixed set of components that are forecasted as a unit. The default value for the field is blank and will include components and product kits in the build process. The process creates a demand record for each product kit and for each component in the product kit.</p> <p>Forecast kit options include:</p> <p><i>Components:</i> Select to include only the components in the build process. The process creates a demand record for each component in the product kit.</p> <p><i>Product Kits:</i> Select to include only product kits in the build process. The process creates a demand record for each product kit.</p> <p>During inventory policy generation, PeopleSoft Inventory Policy Planning can react to the kits and explode product kit items into its components. The Policy Generation (DP_CALCPOLCY) process matches inventory policy items and attributes for use in the PeopleSoft Inventory system.</p> <p>See "Understanding Product Kits" (PeopleSoft Inventory).</p>
Calendar ID	<p>Select a calendar to be exported and used by the integration.</p> <p>See Understanding Calendars.</p>
Weight Profile	<p>Select the weight profile that you want to use for the export. The profile determines which dates are working and nonworking days. The system also associates weight profiles with a calendar, so the values that are available for this field depend on the calendar ID that you selected.</p>

Demand Source

The check boxes that you select indicate that the system will include data from that source when it runs the export process.

Shift Definition

Enter shift information. This data is used to populate the Shift information text files required by the Process Integration Pack used for integrating to Demantra.

Selection Criteria

Use the grid to provide filter elements for the data subset. The feature makes it possible for you to control and filter ranges of data or types of data to be selected for export. You create the subset by establishing selection criteria for the field. For example, if you want to limit the number of items or only select data for a specific location, you can select a range of records to limit the **Item Code** or **Location** field.

Field or Control	Description
Open ((open parenthesis)	Select the open parenthesis character to signify the start of a group of criteria that you want to enclose. For example, if you have three criteria, you can create a selection criteria of (A or B) and C by placing an open parenthesis on the line for A.
Field Name	Select a field on which to filter. The system uses the field you define as the basis for further limiting data when you use the Criteria field. Fields that are available for selection are dependent on the function that you use.

Field or Control	Description
Operator	<p>Determines the action that the system applies to the criteria that you enter in the Criteria field. For example, suppose you want only item IDs that start with AA to be placed in the data file, use the = (like) operator. You should enter the correct form of the criteria to match the operation that you want the system to perform. Available operators depend on the page that you use.</p> <p>Values include:</p> <ul style="list-style-type: none"> • <: Include values that are less than the value that you enter in the Criteria field. • <>: Include values that are not equal to the value that you enter in the Criteria field. • =: Include only values that are equal to the criteria. • >=: Include values that are equal to or greater than the criteria. • <i>BETWEEN</i>: Include only values between the two values that you enter as criteria. This operation requires a list with values that are appropriate to the fields that are selected for string values. For example, a string might be A, B, C, and D. You enter A and D to include B and C values only. Values can include numeric strings. • <i>IN</i>: Include records that contain the criteria that you enter. This operation requires a list with values that are appropriate to the fields that are selected for string values. Values can include numeric strings. • <i>LIKE</i>: Include only values that match the value that you enter. The criteria must include at least one wildcard character. For example, you could use Apple%. This would select values starting with Apple while %Ap% would select values containing Ap. • <i>NLIK</i>: Include values that do not match this value. This option restricts values from the data subset. The value must include at least one wildcard character. • <i>NOT BET</i>: Include values that are not between the two values that you enter in the Criteria field. • <i>NOT IN</i>: Include values that are not in the range of values that you enter as selection criteria.

Field or Control	Description
Criteria	Enter the value that you want the system to use when applying the operators. For example, if you select >= for an Item Code field and enter <i>AA100</i> as the criteria, then the system includes only values that are equal to or greater than the criteria.
Close) (close parenthesis)	Select the close parenthesis character to signify the end of a group of criteria that you want to enclose. For example, if you have three criteria, you can create a selection criteria of (A or B) and C by placing an close parenthesis on the line for B.
Next	Provides a means of creating And or Or statements for the operators and criteria that you enter. Use the <i>AND</i> option to create additional criteria for the field. Use the <i>OR</i> option to create contrasting criteria.

Maintaining Export Controls Page

Use the Maintain Export Controls page (FINT_DDH_CONTROL) to maintain export controls that define how the system should process demand data history.

Navigation:

SCM Integrations > Advanced Planning > Demantra > Maintain Export Controls

This example illustrates the fields and controls on the Maintain Export Controls page. You can find definitions for the fields and controls later on this page.

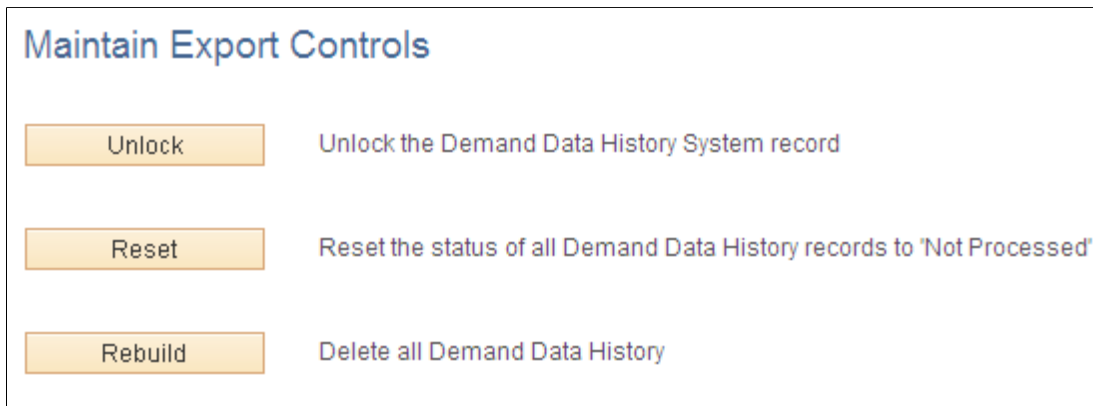

Use this page to define how the system should process demand history data when exporting data to Demantra.

Field or Control	Description
Unlock	Select to unlock the demand data history record in the event of a failure or other problem. Do not use this option when the build or load processes are running.
Reset	Select to reset the status of all demand data history records to the status of not processed. You normally only use this option during system start up. Warning! This resets the status of all demand data history records to <i>Not Processed</i> .
Rebuild	Select to delete all demand data history records. You normally only use this option during system start up. Warning! Selecting this option deletes all demand history.

Export Demand Page

Use the Export Demand page (FINT_EXPORTDMD) to export demand to Demantra Demand Management.

Navigation:

SCM Integrations > Advanced Planning > Demantra > Export Demand

This example illustrates the fields and controls on the Export Demand page. You can find definitions for the fields and controls later on this page.

The screenshot shows the 'Export Demand' page interface. At the top, there are links for 'Run Control ID d1', 'Report Manager', and 'Process Monitor', along with a 'Run' button. Below these are several input fields: '*Specification ID' (a dropdown menu), 'Description' (a text box), '*From' (a date picker), and '*To Date' (a date picker). A section titled 'Range of Data' contains five checkboxes: 'Sales' (checked), 'Base' (unchecked), 'Customer' (checked), 'Calendars' (unchecked), and 'User Data' (unchecked). At the bottom, there is a 'File Path' text box.

Use this page to define run controls and initiate the Export Demand History (FINT_DMD_EXP) process.

Field or Control	Description
Specification ID	Select an export specification. An export specification defines the demand history data set that you want to export for use with the integration to Demantra Demand Management.
Edit Export Specification	Click to access the export specification that you selected to use with this run control. Using the page, you can make updates to specifications to refine the demand history data to use with the export process.
From and To Date	Select the date range from which to include demand history data for this export process.
Sales, Base, Customer, Calendars, and User Data	Select which data to export from PeopleSoft. Selecting any check box also creates a number of empty xml files required by the integration. <ul style="list-style-type: none"> • Select the Sales check box to create the SalesOrderHistory.txt file. • Select the Base check box to create the Base.xml file. • Select the Customer check box to create the Customer.xml file. • Select the Calendar check box to create the Calendar.txt file. • Select the User Data check box to create the ShiftInformation.txt, ShiftInformationDetails.txt, and StandardUOMConversions.txt files.
File Path	Enter the location where you want the export Integration files to be created.

Importing Data from Demantra

This section discusses how to define import specifications and import forecasts.

Pages Used to Import Data From Demantra

Page Name	Definition Name	Usage
<u>Defining Import Specifications Page</u>	FINT_IMP_SPEC	Define import specifications by setting up parameters for loading forecast data sent from the Demantra Demand Management system into PeopleSoft publish tables.

Page Name	Definition Name	Usage
<u>Import Forecasts Page</u>	FINT_IMPORT_FCST	Import forecasts from Demantra Demand Management.
Copy Import Specifications Page	FINT_COPYIMP_SPEC	Create an import specification by copying the attributes of an existing specification. The system copies the specification parameters and the selection criteria from the specification.
Delete Import Specifications Page	FINT_DEL_IMP_SPEC	Delete import specifications.

Defining Import Specifications Page

Use the Define Import Specifications page (FINT_IMP_SPEC) to define import specifications by setting up parameters for loading forecast data sent from the Demantra Demand Management system into PeopleSoft publish tables.

Navigation:

SCM Integrations > Advanced Planning > Demantra > Define Import Specifications

This example illustrates the fields and controls on the Define Import Specification page. You can find definitions for the fields and controls later on this page.

Define Import Specification

Specification DASD

Description: Quarterly Forecast

*Publish Name: DASD1

*Map ID: ITM

*Calendar ID: DEFAULT

*Time Period Code: WEEK

*Weight Profile: DEFAULT

Publish Daily Weights

*File Path:

Selection Criteria

Open (Field Name	Operator	Criteria	Close)	Next

Importing data is the process of retrieving forecast information sent from Demantra Demand Management by the Process Integration Package and loading that into PeopleSoft publish tables. You use an import specification to define the forecast information that you want to include and where the forecast data file resides.

Field or Control	Description
Calendar ID	Select a calendar for use by the import specification. Calendars provide the time horizon over which the forecast operates.
Time Period Code	Select a code for the selected calendar for the specification. A period definition is comprised of the number of periods per year and the total number of periods within the calendars date range. The period code defines the date range for each period and thus the size of the time buckets into which forecasts will be grouped.
Weight Profile	Select the weight profile that you want to use for this import specification. The profile determines the weights that are associated with each time period and is used when the Publish Daily Weights check box is selected. The system associates weight profiles with a calendar.
Publish Daily Weights	Select to have the system automatically publish the daily weights associated with the calendar for this import specification. Other applications use these weights to convert the published forecast into daily time periods for aggregation or reporting purposes. The default value is to include daily weights. You can publish daily weights regardless of what time period code you select for the specification.
File Path	Enter the file name and path to the location of the external file that you want to import. The system imports the file only when you select to import the forecasts.

Selection Criteria

Use the grid to provide filter elements for the data subset. The feature makes it possible for you to control and filter ranges of data to be selected. You create the subset by establishing selection criteria for either items or locations.

Import Forecasts Page

Use the Import Forecast page (FINT_IMPORT_FCST) to import forecasts from Demantra Demand Management.

Navigation:

SCM Integrations > Advanced Planning > Demantra > Import Forecast

This example illustrates the fields and controls on the Import Forecast page. You can find definitions for the fields and controls later on this page.

Import Forecast

Run Control ID **IMPQ1** [Report Manager](#) [Process Monitor](#) Run

User ID **VP1**

*Specification

Publish Name

Description

*Publish Date

Use this page to define run controls and initiate the Import External Forecast (FINT_FSTIMP) process.

<i>Field or Control</i>	<i>Description</i>
Import Specification	Select an import specification. An import specification defines how data will be imported into the PeopleSoft publish tables from the file of forecasts supplied from Demantra Demand Management.
Edit Import Specification	Click to access the Define Import Specification page where you can make changes to an import specification before running the Import External Forecast process. Make sure that you save the data that you entered for this run control ID before editing the specification. Note: This field is not available until you select an import specification.
Publish Name	Enter the name used to identify the forecast data set. The name is a label that applications use to identify the publish activity. The name is a logical name that you can use to access and use the forecast data set again and again.
Description	Enter a description that to further describes the specification.
Publish Date	Select the date that you want to use as the publish date for this Import External Forecasts process run.

Reviewing and Updating Imported Forecasts

This section discusses how to review imported forecasts and update forecasts.

Pages Used to Review and Update Imported Forecasts

<i>Page Name</i>	<i>Definition Name</i>	<i>Usage</i>
Review Imported Forecasts Page	FINT_IMPORTFCSTINQ	Access imported forecast data using a forecast publish name or publish date.
Review Imported Forecasts (search criteria) Page	FINT_IMPFCST_FILT	Define search criteria for reviewing forecasts.
Forecast Item Details Page	FINT_IMPFCST_TABLE	Review imported forecast details.
Forecast Period Data Page	FINT_IMPFCST_DET	Review forecast period data.
Forecast Update Page	FINT_RDOUPD_RUN	Update imported forecasts.

Review Imported Forecasts Page

Use the Review Imported Forecasts page (FINT_IMPORTFCSTINQ) to access imported forecast data using a forecast publish name or publish date.

Navigation:

SCM Integrations > Advanced Planning > Demantra > Review Imported Forecasts

This example illustrates the fields and controls on the Review Imported Forecasts search page. You can find definitions for the fields and controls later on this page.

Use this page to define the search criteria for the imported forecast information that you want to review. The page header information displays the publish name, date, and map ID that you selected. After defining selection criteria, click the **Search** button to retrieve the search results. Click the **Clear Filter** button to remove selection criteria entries.

Note: If you do not define search criteria, the system retrieves all the forecast details for the imported forecast.



Forecast Item Details Page

Use the Forecast Item Details page (FINT_IMPFCST_TABLE) to review imported forecast details.

Navigation:

Click the **Search** button on the Review Imported Forecasts search criteria page.

This example illustrates the fields and controls on the Forecast Item Details page. You can find definitions for the fields and controls later on this page.

Forecast Item Details						
Publish Name SEPTEMBER		Forecast Publish Date 09/28/2003 Return to Filter				
Item Details						
Personalize Find View All  				First	1-15 of 88	Last
Forecast Item	Item Code	Location	Weight Profile	Base Unit	Publish Unit	
ACCESS:MOUNTAIN:10009:FRA05	10009	FRA05	EVENLOAD	EA	EA	
ACCESS:MOUNTAIN:10009:GBR02	10009	GBR02	EVENLOAD	EA	EA	
ACCESS:MOUNTAIN:10009:US010	10009	US010	EVENLOAD	EA	EA	
ACCESS:MOUNTAIN:10009:US011	10009	US011	EVENLOAD	EA	EA	
ACCESS:MOUNTAIN:10010:FRA05	10010	FRA05	EVENLOAD	EA	EA	
ACCESS:MOUNTAIN:10010:GBR02	10010	GBR02	EVENLOAD	EA	EA	
ACCESS:MOUNTAIN:10010:US010	10010	US010	EVENLOAD	EA	EA	
ACCESS:MOUNTAIN:10010:US011	10010	US011	EVENLOAD	EA	EA	
ACCESS:MOUNTAIN:10011:FRA05	10011	FRA05	EVENLOAD	EA	EA	
ACCESS:MOUNTAIN:10011:GBR02	10011	GBR02	EVENLOAD	EA	EA	
ACCESS:MOUNTAIN:10011:US010	10011	US010	EVENLOAD	EA	EA	
ACCESS:MOUNTAIN:10011:US011	10011	US011	EVENLOAD	EA	EA	
APPAREL:COMMON:10000:FRA05	10000	FRA05	EVENLOAD	EA	EA	
APPAREL:COMMON:10000:GBR02	10000	GBR02	EVENLOAD	EA	EA	
APPAREL:COMMON:10000:US010	10000	US010	EVENLOAD	EA	EA	

Using the Forecast Item Details feature, you can review forecast item information and access forecast period data and weight profiles.

Field or Control	Description
Forecast Item	Displays the logical item/location combination for the imported forecast data. Click the link to access the Forecast Period Data page where you can review additional forecast information.
Item Code	Displays the item code used to define an item across the organization.
Location	Displays the location or business unit for the forecast data.

Field or Control	Description
Weight Profile	Displays the weight profiles defined for this imported forecast data set. Weight profiles are templates that you use to create and maintain daily weights for calendars. One weight profile must be defined on each imported forecast data set. See Calendar Weight Profiles Page .
Base Unit	Displays the unit of measure (UOM) in which the system stores demand and forecast quantities for the selected forecast item. This is also the UOM that is associated with all standard prices and costs.
Publish Unit	Displays the unit of measure in which the forecast was published.

Forecast Period Data Page

Use the Forecast Period Data page (FINT_IMPCST_DET) to review forecast period data.

Navigation:

Click a **Forecast Item** link on the Forecast Item Details page.

This example illustrates the fields and controls on the Forecast Period Data page. You can find definitions for the fields and controls later on this page.

Forecast Period Data					
Publish Name SEPTEMBER			Publish Date 09/28/2003		
Forecast Item ACCESS:MOUNTAIN:10009:FRA05			Return to Item Details		
Period Data					
Personalize Find View All First 1-12 of 36 Last					
Period	Year	Start Date	End Date	Forecast Value	
9	2002	09/01/2002	09/30/2002	106.0000	
10	2002	10/01/2002	10/31/2002	110.0000	
11	2002	11/01/2002	11/30/2002	111.0000	
12	2002	12/01/2002	12/31/2002	124.0000	
1	2003	01/01/2003	01/31/2003	116.0000	
2	2003	02/01/2003	02/28/2003	112.0000	
3	2003	03/01/2003	03/31/2003	118.0000	
4	2003	04/01/2003	04/30/2003	127.0000	
5	2003	05/01/2003	05/31/2003	142.0000	
6	2003	06/01/2003	06/30/2003	132.0000	
7	2003	07/01/2003	07/31/2003	134.0000	
8	2003	08/01/2003	08/31/2003	149.0000	

This page provides basic details about the imported or published forecast period data. The data includes period-by-period values for the imported (published) forecast. Select the **Return to Item Details** link to return to the Forecast Item Details page

Field or Control	Description
Period	Displays the period to which this row of data pertains.
Year	Displays the year in which the period belongs.
Start Date and End Date	Displays the beginning and ending dates for the forecast period.
Forecast Value	Displays the total value of the forecast for the forecast period. The value appears in the published unit of measure.

Forecast Update Page

Use the Forecast Update page (FINT_RDOUPD_RUN) to update imported forecasts.

Navigation:

SCM Integrations > Advanced Planning > Demantra > Forecast Data Update

Use this page to run the FINT_FSTUPD process to update the imported forecasts.

Field or Control	Description
Publish Name	Select the name used to identify the imported forecast data. The name is a label that applications use to identify the publish activity. The name is a logical name that you can use to access and use the forecast data set again and again.
Forecast Set	Select the forecast set. The set contains the latest imported forecast set.
Item/Product Forecasts	Select whether to update the forecast based on the item forecast or the product forecast.
Forecast Update Method	Select the method that you want to use to update the forecast. Values include: <i>Complete</i> : Select to update the complete forecast set. <i>Replace</i> : Select to replace only those forecast items or products records that have been updated.

Calculating Sales and Use Tax in Supply Chain Management

Understanding PeopleSoft Tax Solutions

This section discusses:

- Comparing PeopleSoft tax tables to third-party tax suppliers.
- Understanding tax integration technologies.

PeopleSoft Billing supports the use of five sales and use tax solutions: PeopleSoft Tax Tables and two solutions each from the suppliers Vertex and Taxware. PeopleSoft Tax Tables, included with PeopleSoft Billing, meets simple sales tax requirements but requires you to maintain tax rates. Provided interfaces enable PeopleSoft Billing to use two third-party tax suppliers: Taxware and Vertex. These suppliers provide solutions to the most complex sales tax requirements and maintain tax rates for you.

Note: If you use Taxware Sales and Use Tax, the Taxware STEP and Verazip modules are optional but recommended. Check with the tax suppliers for the versions of their software that are available for the different releases of PeopleSoft.

Comparing PeopleSoft Tax Tables to Third-Party Tax Suppliers

Third-party tax solutions provide a more complex set of features for sales and use tax calculations than PeopleSoft tax tables. The following table compares PeopleSoft tax tables with third-party solutions:

<i>PeopleSoft Tax Tables</i>	<i>Third-Party Solutions</i>
You must manually maintain tax rates.	The supplier provides monthly tax updates.
You must determine and manually check for exemptions. Exemption status is not determined at the time of calculation. If an order line, bill line, or purchase order line is not marked as tax-exempt, taxes are calculated.	The tax supplier system determines exemption status at the time of tax calculation. The tax supplier system maintains customer exemption certificates and product tax rules.

PeopleSoft Tax Tables	Third-Party Solutions
<p>Tax rates come from the tax authorities of a tax code on the transaction. A tax code loosely represents a taxing jurisdiction. In PeopleSoft Billing, the tax code can be entered manually on a bill line, or it can be populated automatically from the ship to customer onto the bill during bill entry or through the bill interface. In PeopleSoft Order Management, the tax code can be entered manually, or it can be populated automatically from the ship to customer for the order line or schedule. In PeopleSoft Purchasing, the tax code can be entered manually on a purchase order, or it can be populated automatically from the ship to location to the purchase order schedule.</p>	<p>Tax rates and jurisdictions are determined from ship to, ship from, order origin, and order acceptance address information on the transaction.</p>
<p>Tax liability is maintained in separate accounts for each tax authority.</p>	<p>Tax liability is maintained in one account for the business unit.</p>

Understanding Tax Integration Technologies

PeopleSoft supports integration with four sales and use tax solutions from two third-party suppliers:

- Taxware Enterprise
- Vertex O Series
- Taxware Sales and Use Tax
- Vertex Q Series

Web Service Integrations

Taxware Enterprise and Vertex O Series are both implemented as web services. PeopleSoft applications communicate with these web services through the PeopleSoft Integration Broker. The Integration Broker uses the URL of the web service to conduct transactions with these tax solutions.

Business Interlink Integrations

PeopleSoft applications communicate with Taxware Sales and Use Tax and Vertex Q Series through Business Interlink objects and plug-ins. The Business Interlink object is part of the PeopleSoft system, but the Interlink plug-ins and associated integration software are provided by Taxware or Vertex. The plug-in and integration software must be installed on the PeopleSoft application and Process Scheduler servers. Initialization files, the Microsoft Windows Registry, or environment variables are used to store the information needed to connect to the main tax solution software and databases.

Note: PeopleSoft Business Interlink is a deprecated product. These options currently exist for upgrade compatibility and transition.

The following diagram shows how the PeopleSoft interlink object communicates with the interlink plug-in, which in turn communicates with the tax solution and database through the supplier shared libraries.

The following diagram shows how the PeopleSoft interlink object communicates with the interlink plug-in

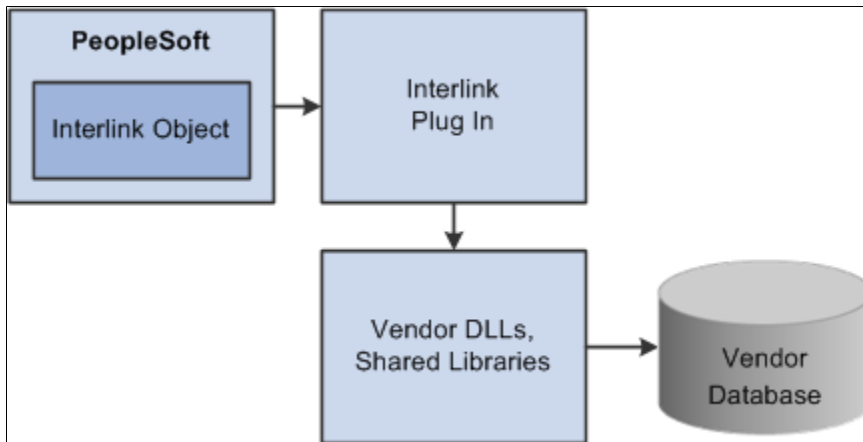

The generic tax supplier dynamic link libraries (DLLs), or shared libraries, are typically delivered by the tax suppliers to all customers. Each supplier has a unique set of DLLs. The tax supplier database objects are the repositories for geocodes, tax rates, exception information, and transactions.

Note: An Interlink plug-in can also be installed on a Windows client running the PeopleSoft Application Designer to facilitate two-tier testing. Additional supplier-supplied software may be required, as typically only software for the target production operating system is provided.

For technical details about individual EIPs, use the Interactive Services Repository (ISR) in the My Oracle Support website located at <https://support.oracle.com/CSP/ui/flash.html>.

Related Links

[Understanding PeopleSoft Integration With Vertex O Series](#)

[Understanding PeopleSoft Business Interlinks to Vertex Q Series](#)

[Understanding PeopleSoft Integration With Taxware Enterprise](#)

[Understanding PeopleSoft Business Interlinks to Taxware Sales and Use Tax](#)

Setting Up Third-Party Tax Solutions

You must perform the following steps to configure PeopleSoft applications to conduct transactions with a third-party tax solution. The third-party tax supplier software should be physically installed and running before carrying out these steps.

To set up PeopleSoft to use a third-party tax solution for tax calculations:

1. Select a tax supplier on the Installation Options - Overall page.

The selection in the **Tax Supplier** list box indicates which tax supplier's solution is installed for the PeopleSoft database. This tax supplier validates postal codes on customer address, supplier address, location address, and transaction address pages.

2. Define the tax solution installation options on the Tax Provider Installation page.

3. Select whether to use the tax supplier on the Billing Definition - Business Unit 2 page and the Taxes and Currency page of the PeopleSoft Order Management business unit definition.

Transactions in these business units have tax calculations performed by the installed tax supplier.

4. (Required for PeopleSoft Purchasing) Select whether to use the tax supplier on the Purchasing Definition - Business Unit Definition page.

Order to Cash-Specific Tax Supplier Setup

Complete these steps for PeopleSoft Billing and PeopleSoft Order Management:

1. Set up tax customer groups.

You can associate ship to customers with tax customer groups by selecting *Tax* as the group type. The system passes both the customer ID and tax customer group through the interface to the tax supplier to find exceptions in the tax supplier database based on customer or customer group.

2. Predefine exemption certificates for eligible customers on the General Information - Tax Exempt Certificate Info page, if customer exemption will be maintained in PeopleSoft instead of in the third-party tax supplier's database.

When you enter sales orders that are exempt from taxes, select the **Tax Exempt** check box on the Header Ship-To Defaults page, and select from the exemption certificates defined for the customer.

When entering bill lines that are exempt from taxes, select the **Tax Exempt** option on the Standard Billing - Line - Tax Info page, and select from the exemption certificates defined for the customer.

The **Tax Exempt** option on the sales order or bill line is the only way to override third-party tax supplier tax rules. The third-party tax supplier software logs the transaction as a user exception and does not tax the line.

The following steps are specific to PeopleSoft Order Management:

1. Define tax options for a product on the Product Definition - Options page.

Associate a tax product number defined on the third-party tax database with the product identifier. The system passes the tax product number to the third-party tax supplier system during tax calculation. You can define special rates or exceptions for the tax product number in the tax supplier system. The third-party tax supplier determines the correct tax rate for the product.

The transaction type and subtype that you enter are default values that the system passes to the third-party tax supplier system during tax calculation.

2. Associate the product with a tax product group on the Product Group page.

The system passes the tax product group to the third-party tax supplier system during tax calculation. You can define special rates or exceptions for the tax product group in the tax supplier system. The third-party tax supplier determines the correct tax rate for the product group.

The following step is specific to PeopleSoft Billing:

Define tax defaults for Billing charge codes on the Charge Code page.

Associate a charge code tax group with a Billing charge code. Also define a default transaction type and subtype to be passed to the third-party tax supplier system during tax calculation for a bill line for this charge code.

Related Links

"Adding General Customer Information" (PeopleSoft Order to Cash Common Information)

"Setting Up Cross-Application Installation Options" (Application Fundamentals)

"Defining Tax Provider Installation Options" (Application Fundamentals)

"Understanding the Sales Order Entry Form" (PeopleSoft Order Management)

"Understanding PeopleSoft Billing Business Units" (PeopleSoft Billing)

"Understanding the Product Definition" (PeopleSoft Order to Cash Common Information)

"Understanding Business Units in PeopleSoft Purchasing" (PeopleSoft Purchasing)

Using Tax Product Groups

Set up charge code and product tax groups to take advantage of exception processing in the third-party tax supplier system. These tax groups must be defined in the tax supplier system. You can create or update charge codes and products with the applicable tax groups. In PeopleSoft Billing, the system populates the default charge code tax group on a bill during bill entry, and the system passes that value to the tax supplier during tax calculation.

PeopleSoft correlates the tax group to a different entity in each of the supported tax solutions.

<i>Tax Solution</i>	<i>Tax group equivalent</i>
Vertex Q Series	Product Category
Vertex O Series	Product Class
Taxware Sales and Use Tax	Product Code
Taxware Enterprise	<p>Not used.</p> <p>In Order Management, the product code corresponds to the Taxware Enterprise goods/services code.</p> <p>In Billing, the identifier corresponds to the Taxware Enterprise goods/services code.</p>

If you use Taxware Sales and Use Tax system, you can

- Create tax groups equivalent to the product codes supplied by Taxware that apply to your business.
- Map the tax groups defined in PeopleSoft to Taxware product codes within Taxware.
- Use the Taxware STEP system to set up tax exceptions for tax groups defined in PeopleSoft that are not equivalent to Taxware product codes.

If you use Vertex, you can set up tax exceptions for product categories or classes and product IDs. The product categories or classes defined in Vertex should also be defined as tax groups in PeopleSoft. You

may need to add the products defined in PeopleSoft as Vertex product IDs, if you define tax exceptions by product IDs. If necessary, map the product categories and product IDs defined in Vertex Q Series to product categories and subcategories defined in Vertex Q Series Taxability Mapping Tool (TMT).

Tax Product Groups in PeopleSoft Order Management

The sales order line and schedule designate a product ID. You can associate a tax product group with the product. PeopleSoft Order Management sends the product ID and the tax product group to the third-party tax supplier system, which determines what takes precedence when retrieving the appropriate tax rate used in tax calculation.

Tax Product Groups in PeopleSoft Billing

The bill line contains two product-related fields: the **Identifier** field and the **Tax Group** field. The system passes both fields to the third-party tax supplier system. When you enter a line during bill entry, the default tax group on the line appears from the tax group associated with the charge code used as the identifier.

Related Links

"Understanding the Product Definition" (PeopleSoft Order to Cash Common Information)

Associating Address Information with Geocodes

A combination of addresses stored on a transaction enables the tax supplier system to determine which taxing jurisdictions and tax rates to use. Each address can be associated with a geocode provided by the tax supplier system.

This section provides an overview of geocodes and discusses how to associate customer and location addresses with geocodes.

Note: The term *Tax Area ID* is used in place of *Geocode* in Vertex O Series. *Geocode* is used within PeopleSoft applications for all third-party tax solutions.

Page Used to Associate Address Information with Geocodes

<i>Page Name</i>	<i>Definition Name</i>	<i>Usage</i>
Tax Geocode Selection Page	TAX_GEOCODE_TMP	Select a geocode to associate with an address.

Understanding Geocodes

Both Taxware and Vertex use geocodes, although each tax supplier system uses it differently. On any page where geocodes can be assigned, you can click the **Geocode Lookup** link to access the Tax Geocode Selection page. This link appears only if the installation options specify a tax supplier and the address country is U.S.A. or Canada.

During geocode lookup, the system passes address information such as address line 1, city, county, state, postal code, and country to the third-party tax supplier. The tax supplier software uses these address fields to determine a geocode.

Note: Address combinations must be valid in order to ensure that the third-party tax supplier software returns a valid geocode. For example, the city, state, and postal code combination must be valid.

Invalid addresses produce a jurisdiction determination error, which prevents the system from calculating taxes.

Note: During tax calculation, if address information is passed to Vertex without a geocode, Vertex assigns the geocode with the highest tax rate from the possible choices.

Refer to the third-party tax supplier documentation for more details on how your tax solution uses geocodes or tax area IDs.

Tax Geocode Selection Page

Use the Tax Geocode Selection page (TAX_GEOCODE_TMP) to select a geocode to associate with an address.

Navigation:

Click the **Geocode Lookup** link on an address page.

<i>Field or Control</i>	<i>Description</i>
Geocode	Select a single geocode to associate with an address.
Auto Fill Address	Select to have the system populate the address page with information from the selected geocode.
In City Limit	If populated, indicates that the address is within the city limit.

Warning! When you select a geocode, the city and state from the geocode page overrides the city and state on the original address page, if you also selected the **Auto-Fill Address** option. If you attempt to change the state or city after a geocode has been assigned, a warning message appears with the option to clear old geocodes, to prevent inconsistency between the assigned geocode and the rest of the address.

Related Links

"PO ShipTo Address Page" (PeopleSoft Purchasing)

Interacting with Third-Party Tax Suppliers

PeopleSoft Billing, PeopleSoft Order Management, and PeopleSoft Purchasing interact with third-party tax software for the following reasons:

- Geocode lookup.

- Online tax calculation in PeopleSoft Order Management, PeopleSoft Billing, and PeopleSoft Purchasing.
- Order completion processing (batch processing in PeopleSoft Order Management).
- Invoicing (batch processing in PeopleSoft Billing).
- Procurement card processing (batch processing in PeopleSoft Purchasing).

Note: The ship to customer ID and address number are required for all third-party tax processing in Order Management and Billing.

The system does not send the transaction to Vertex Q Series or Taxware Sales Tax for calculation if the ship to address is not a U.S. or Canadian address.

Maximum tax calculation is supported at the line level and the document level with release 8.9. Prior to release 8.9, maximum tax calculation is supported at the line level only.

Calculating Taxes in PeopleSoft Order Management

In PeopleSoft Order Management, the system calculates and saves taxes when you change the order and click the **Calculate Price** button. The Order Completion process calculates taxes for orders that are entered using electronic data interchange, returned material authorization replacement sales orders, and buying releases. The system uses this tax information when printing sales orders acknowledgments and quotations. You can also view the summarized tax amount on the Order Entry Form page.

The calculated tax amount is only an estimate of taxes for an order, and it is not posted to any tax registers. If you have PeopleSoft Billing installed, the system recalculates taxes even if they have been calculated previously in the order entry process online or by the Order Completion process.

Note: For typical sales orders where the payment is set to on account, PeopleSoft Order Management does not pass tax calculations to PeopleSoft Billing. However, in the counter sale environment, the tax calculations are passed to Billing. Taxes will not be recalculated in Billing when the transaction is fully paid up front and your installation is using the PeopleSoft tax solution as opposed to a third-party tax solution.

Calculating Taxes in PeopleSoft Billing

In PeopleSoft Billing, the system calculates taxes when you click the **Calculate Taxes** button on the Bill Summary page, and when you run the pro forma or finalization processes.

Note: The system does not calculate taxes or VAT for a bill line when the bill line's tax timing option (populated by PeopleSoft Contracts) is defined as *S* (taxes on services rendered).

Calculating Taxes in PeopleSoft Purchasing

In PeopleSoft Purchasing, the system calculates taxes when you:

- Click the **Calculate** button on the Maintain Purchase Order - Purchase Order page or the Express Purchase Order - Purchase Order page when entering a purchase order or a change order online.
- Click the **Calculate SUT** (calculate sales/use tax) button on the Maintain Purchase Order - Sales/Use Tax Information for Schedule page or Express Purchase Order - Sales/Use Tax Information for Schedule page when entering a purchase order or change order online.

- Perform the Purchase Order Calculations Application Engine process (PO_POCALC) that creates purchase orders.
- Perform the Change Purchase Order Application Engine process (PO_POCHNG) that creates change orders.

When you perform one of these actions, the system evokes the TaxCalc API process, which calculates your sales and use tax.

Related Links

"Running Order Completion/Repricing" (PeopleSoft Order Management)

"Creating Purchase Order Headers" (PeopleSoft Purchasing)

"Creating Purchase Order Schedules" (PeopleSoft Purchasing)

Interacting with Third-Party Tax Solutions During Geocode Lookup

If you selected a third-party tax supplier on the Installation Options - Overall page, the system displays a geocode lookup link on the following pages:

- Location - Location Definition page.
- Customer address pages.
- Sold-to Address Override page.
- PeopleSoft Billing Ship-to Override page.
- PeopleSoft Purchasing Schedule One-Time Address page.

When you click the geocode lookup link, for a U.S. or Canadian address, PeopleSoft will request the geocode from the external tax system. The system displays geocode results from the tax supplier system on the Tax Geocode Selection page.

Note: Although selecting Taxware or Vertex as the tax supplier on the Installation Options - Overall page enables geocode lookups, business units must also be set up for tax calculations to be performed through a third-party tax solution.

For technical details about individual EIPs, use the Interactive Services Repository (ISR) in the My Oracle Support website located at <https://support.oracle.com/CSP/ui/flash.html>.

Related Links

"Running Order Completion/Repricing" (PeopleSoft Order Management)

"Setting Up Cross-Application Installation Options" (Application Fundamentals)

"Setting Up Locations" (Application Fundamentals)

"Entering Bill Source Information" (PeopleSoft Billing)

"PO ShipTo Address Page" (PeopleSoft Purchasing)

Interacting with Third-Party Tax Suppliers During Online Tax Calculations

You can initiate online tax transactions in PeopleSoft Order Management, Billing, and Purchasing.

Online Tax Calculation in PeopleSoft Order Management

You trigger online tax calculations in PeopleSoft Order Management on the order line and order schedule pages by saving a valid order or clicking the **Calculate Price** button on the Order Entry Form or Shipment Schedules page.

PeopleSoft conducts a transaction with the external tax system, either through a web service or a business interlink. The data passed to the tax system in the transaction includes the tax company or organization, customer information including addresses, product information, and the line or schedule quantity, and the line or schedule amount. PeopleSoft Order Management tables are updated with tax information, including the tax amount and tax percentage.

Note: The taxes calculated in PeopleSoft Order Management are only temporary and are not logged by the tax supplier software. Actual taxes will be calculated when the invoice is finalized in Billing. In the case of fully paid sales orders, the Billing Finalization process sends the invoice to the tax solution so that the amounts can be logged. Billing uses the original transaction date so that the taxes logged will match the taxes paid, in case the tax rules have changed since the sales order was taken.

Online Tax Calculation in PeopleSoft Billing

You trigger online tax calculations on the Bill Summary Info page when you click the **Calculate Taxes** button, if the current PeopleSoft Billing business unit is defined as using an installed third-party tax supplier. When you click **Calculate Taxes**, the following occurs:

1. PeopleSoft conducts a transaction with the external tax system, either through a web service or a business interlink.
2. The system displays the total tax amount on the Bill Summary Info page.
3. Click the **Save** button to update the PeopleSoft Billing tables.

You can view the detailed tax information on the Standard Billing - Line Tax page. The taxes calculated from the Bill Summary page are only temporary and are not logged by the supplier software.

Online Tax Calculations in PeopleSoft Purchasing

You trigger online tax calculations when you:

- Click the **Calculate** button on the Maintain Purchase Order - Purchase Order page or the Express Purchase Order - Purchase Order page when entering a purchase order or a change order online.
- Click the **Calculate SUT** button on the Maintain Purchase Order - Sales/Use Tax Information for Schedule page or Express Purchase Order - Sales/Use Tax Information for Schedule page when entering a purchase order or change order online.

Related Links

"Reviewing Bill Summary Information" (PeopleSoft Billing)

"Creating Purchase Order Headers" (PeopleSoft Purchasing)

"Creating Purchase Order Schedules" (PeopleSoft Purchasing)

Interacting with Third-Party Tax Suppliers During Invoicing

PeopleSoft Billing interacts with third-party tax suppliers during pro forma invoicing and invoice finalization. During pro forma invoicing, the system writes nothing to the tax supplier audit or registry files; in finalization, the system logs and reports all transactions.

The Pre-Process and Finalization process (BIIVC000) calls the Tax Interface process (BITAX000) when processing pro formas and invoices in business units defined as using a third-party tax supplier. The following occurs in the Tax Interface process:

1. PeopleSoft conducts transactions with the external tax system, either through a web service or a business interlink.
2. The tax amounts are saved on the PeopleSoft Billing tables.
3. If the third-party tax calculation detects errors, the third-party system returns error codes to PeopleSoft.

The system tags the bill and writes the error code to the specific line with the tax error.

In addition, the system enters a line in the message log for the erroneous line.

Note: You can run batch jobs that contain bills requiring both third-party supplier and PeopleSoft tax solution calculations; however, using more than one third-party tax solution is not supported. Only a single third-party supplier solution can be installed for a PeopleSoft database.

Interacting with Third-Party Tax Suppliers During the Order Completion Process

The Order Completion process calls third-party tax suppliers and provides the necessary information to calculate tax for the order. The values for the taxes are estimates and are stored on the order.

Related Links

"Understanding Order Entry Required Processing" (PeopleSoft Order Management)

Viewing Tax Calculation Errors in PeopleSoft Billing

The method that you use to calculate taxes determines how you locate information in PeopleSoft Billing about resulting tax calculation errors.

This section discusses how to:

- View errors when calculating taxes online.
- View errors when calculating taxes through the invoicing process.

Viewing Errors When Calculating Taxes Online

If you calculate taxes online when you click the **Calculate Taxes** button on the Bill Summary Info page, and errors occur, the system displays a message containing the line with tax calculation errors and a supplier error code.

There are three levels of errors you might receive:

- Business interlink connectivity errors indicate missing DLLs or shared libraries, or permission errors.

An error message appears.

- Supplier database connectivity errors indicate trouble connecting to the supplier database.

An error message appears with a supplier return code.

- Tax calculation errors.

An error message appears with supplier return codes. The system writes the error message to the bill line tax record and displays the message on the Standard Billing - Line - Tax Info page.

Related Links

"Reviewing Bill Summary Information" (PeopleSoft Billing)

"Standard Billing - Line - Tax Info Page" (PeopleSoft Billing)

Viewing Errors When Calculating Taxes Through the Invoicing Process

If you calculate taxes from invoice pro forma or finalization, the message log reports how many bills that it finds with errors. On the Invoice and Line Errors page, you can view a list of bill lines and the error codes and descriptions associated with them.

Note: Refer to third-party documentation for a complete description of supplier-returned errors.

Related Links

"Inquiring About Individual Invoice Errors" (PeopleSoft Billing)

Reviewing Third-Party Tax Liability Reporting

When using the PeopleSoft-delivered tax solution, you can set up different liability accounting information for each tax authority. When using Taxware or Vertex, however, each PeopleSoft Billing business unit can have only a single distribution code to use in recording general ledger information for taxes. Canadian tax support is the only exception to this rule.

Comparing US and Canadian Tax Support

The following are some differences between the U.S. and Canadian third-party tax solutions support:

Note: Consult your supplier documentation for more information.

- The tax calculation routines calculate provincial sales tax (PST) and goods and services tax (GST) if given valid postal codes.
- For U.S. taxes, you can only use one sales and use tax liability account for each PeopleSoft Billing business unit in an integration with either Taxware and Vertex.

When you set up a Canadian PeopleSoft Billing business unit, a Billing business unit with a base currency of CAD, an additional distribution field appears that enables you to enter a separate tax liability distribution code for GST. This field appears only when you create a Billing business unit tied to a PeopleSoft General Ledger business unit that uses the Canadian dollar as its base currency.

Reviewing and Modifying Tax Jurisdiction Level Translation

This section provides an overview of the translation of tax jurisdiction levels provided by third-party tax solutions to PeopleSoft tax authority codes and discusses how to modify the translation map used with Vertex O Series.

Pages Used to Modify the Vertex O Series Tax Jurisdiction Translation Map

<i>Page Name</i>	<i>Definition Name</i>	<i>Usage</i>
<u>Define Maps Page</u>	SAC_MAP_DEFN	Identify the map ID, description, and map type for the translation of Vertex O Series tax jurisdiction levels to PeopleSoft tax authority codes.
Map Detail Page	SAC_MAP_DEFN_DTL	Enter the mapping data needed for the translation of Vertex O Series tax jurisdiction levels to PeopleSoft tax authority codes. Documentations talks about having this map id in your system through xml mapper but it doesn't point out how to setup the data that is required if it is missing. It also doesn't include all the mappings necessary for the integration. I have included an attachment with the mappings and data that need to be included in a customers system for this integration.

Understanding Tax Authority Code Translation

The PeopleSoft system translates the tax jurisdiction levels provided by Vertex Q and O Series, and Taxware Sales and Use Tax into a standard, PeopleSoft code. The PeopleSoft codes include:

- *ST*: State tax.
- *CTY*: City tax.

- *CNY*: County tax.
- *DST*: District tax.
- *SCN*: Secondary county tax.
- *SCI*: Secondary city tax.
- *SDI*: Secondary district tax.
- *GST*: Canadian goods and services tax.
- *PST*: Canadian provincial sales tax.
- *OTH*: Other.

Taxware Enterprise provides the PeopleSoft codes directly; no translation will take place. You can modify the mapping of Vertex O Series tax jurisdiction levels to tax authority codes using the XML Mapper component. You cannot modify the translation of authority codes used with Vertex Q Series or Taxware Sales and Use Tax.

Define Maps Page

Use the Define Maps page (SAC_MAP_DEFN) to identify the map ID, description, and map type for the translation of Vertex O Series tax jurisdiction levels to PeopleSoft tax authority codes.

Navigation:

SCM Integrations > XML Mapper > Define Maps

1. With the search page, select the map with the **Map ID**, *VERTEXO_JURISDICTION*.
2. Select the Map Detail tab to access the Map Detail page.
3. Modify the entries in the **Static Transformation** grid.

Note: The * character in the **External Value** column represents unmapped codes coming from Vertex.

4. Click **Save**.

The following mappings are necessary for the integration:

- Map ID VERTEXO_JURISDICTION with map type VALUES ONLY.
- Map ID VERTEXO_TAX_RESULT with map type VALUES ONLY.
- Map ID VERTEXO_TAX_TYPE with map type VALUES ONLY.

The VERTEXO_JURISDICTION map ID should include the following data in the Static Transformation group box of the Map Detail page:

<i>Internal Value</i>	<i>External Value</i>
OTH	*

Internal Value	External Value
CTY	CITY
GST	COUNTRY
CNY	COUNTY
DST	DISTRICT
PST	PROVINCE
ST	STATE

The VERTEXO_TAX_RESULT map ID should include the following data in the Static Transformation group box of the Map Detail page:

Internal Value	External Value
E	EXEMPT
N	NON-TAXABLE
T	TAXABLE

The VERTEXO_TAX_TYPE map ID should include the following data in the Static Transformation group box of the Map Detail page:

Internal Value	External Value
C	CONSUMERS_USE
S	SALES
U	SELLER_USE

Integrating With Vertex O Series

Understanding PeopleSoft Integration With Vertex O Series

PeopleSoft communicates with the Vertex O Series web service through the PeopleSoft Integration Broker and the Vertex PGC (PeopleSoft Generic Connector). To integrate with the Vertex O Series tax solution, you must perform the following configuration steps:

1. Set up your local integration gateway and load the gateway connectors.

The Integration Broker uses the HTTPTARGET connector to communicate with the Vertex web service.

See *PeopleTools: Integration Broker*

2. Activate the TAX_INTEGRATION service operation queue.
3. Activate the service operations and routings.

- DO_TAXCALC_REQ
- GET_GEOCODES_REQ

See Managing Service Operations, *PeopleTools: Integration Broker*

See Managing Routing Definitions, *PeopleTools: Integration Broker*

4. Activate the PSFT_TAX node.
5. Set Vertex as the **Tax Supplier** on the PeopleSoft Financials/Supply Chain Installation Options page and set the appropriate Vertex options on the Tax Provider Installation page.

See [Setting Up PeopleSoft Installation Options for Vertex O Series](#).

Note: When you switch from one Tax Supplier Application to another, such as switching from Vertex Q Series to O Series, any geocodes associated with address records in the PeopleSoft database must be upgraded before tax calculations can be sent to the tax supplier software. The Tax Provider Installation page will display the geocode upgrade process status. You should run the process, allow it to complete successfully, or fix any errors that occur, before proceeding.

6. Configure Billing, Order Management, and Purchasing business units to calculate sales and use taxes through the installed tax supplier and set business-unit level tax supplier options.

See [Setting Up Third-Party Tax Solutions](#).

Related Links

"Tax Provider Geo Code Update Page" (Application Fundamentals)

Configuring Vertex O Series Integration

This section discusses how to activate the TAX_INTEGRATION service operation queue, activate the service operations, activate the routings, and activate the PSFT_TAX node.

Pages Used to Configure Vertex O Series Integration

<i>Page Name</i>	<i>Definition Name</i>	<i>Usage</i>
Queue Definitions Page	IB_QUEUEDEFN	Activate the TAX_INTEGRATION service operation queue.
Service Operation - General Page	IB_SERVICE	Activate the service operations.
Service Operation - General Page	IB_SERVICETRNGS	Activate the routings.
Node Definitions Page	IB_NODE	Activate tax node.

Queue Definitions Page

Use the Queue Definitions page (IB_QUEUEDEFN) to activate the TAX_INTEGRATION service operation queue.

Navigation:

PeopleTools, Integration Broker, Integration Setup, Queues

For the TAX_INTEGRATION queue, verify that the **Queue Status** is *Run*.

Service Operation - General Page

Use the Service Operation - General page (IB_SERVICE) to activate the service operations.

Navigation:

PeopleTools > Integration Broker > Integration Setup > Service Operations

PeopleSoft delivers service operations in PeopleSoft Integration Broker with a default status of *Inactive*. You must activate each service operation before attempting to send or receive data from a third-party source, such as Vertex. To setup a service operation use the information in the table below and refer to the setup instruction in [Setting Up Service Operations](#)

Service Operation	Direction and Type	Handlers	Chunking Available?	Integrates With
DO_TAXCALC_REQ	Outbound Synchronous	Not applicable	No	Vertex O Series or another third-party tax supplier
GET_GEOCODES_REQ	Outbound Synchronous	Not applicable	No	Vertex O Series

See *PeopleTools: Integration Broker Service Operations Monitor*

Service Operation - General Page

Use the Service Operation - General page (IB_SERVICETRNGS) to activate the routings.

Navigation:

PeopleTools > Integration Broker > Integration Setup > Service Operations

Click the Routings tab.

Activate the *DO_TAXCALC_REQ_V2* and the *GET_GEOCODE_REQ_TAX* routings for the *PSFT_TAX* node.

- For the *DO_TAXCALC_REQ_V2* routing, set the PrimaryURL property to the endpoint of the Vertex tax calculation request function.

Typically this will be: `http://<host:port>/pgc/servlet/taxcalc`. Replace `<HOST:PORT>` with the address of the Vertex PeopleSoft generic connector.

- For the *GET_GEOCODE_REQ_TAX* routing, set the PrimaryURL property to the endpoint of the Vertex tax area request function.

Typically this will be: `http://<host:port>/pgc/servlet/taxarealookup`. Replace `<HOST:PORT>` with the address of the Vertex PeopleSoft generic connector.

See Manage Routing Definitions, *PeopleTools: Integration Broker*

Node Definitions Page

Use the Node Definitions page (IB_NODE) to activate tax node.

Navigation:

PeopleTools, Integration Broker, Integration Setup, Nodes

Verify that the *PSFT_TAX* node is active.

See Adding and Configuring Nodes, *PeopleTools: Integration Broker*

Setting Up PeopleSoft Installation Options for Vertex O Series

The Set Up Financials/Supply Chain, Install, Tax Provider Installation page provides the following options for Vertex O Series:

Note: To display options for Vertex O Series, *Vertex* must be chosen as the **Tax Supplier** on the Overall Installation Options page and *Vertex O Series* as the **Vertex Tax Application** on the Tax Provider Installation page.

Field or Control	Description
Tax Supplier Call Options	<p>Determines whether tax calculation transactions are sent to Vertex line by line or as an entire document. The options are:</p> <ul style="list-style-type: none"> • <i>Doc Level</i>: an entire invoice or document is sent to Vertex for tax calculation. • <i>Line Level</i>: tax calculation transactions are sent to Vertex line by line. <p>The <i>Doc Level</i> option allows you to take advantage of invoice and multiline maximum tax rules in some jurisdictions, but when you choose the Doc Level option, returns and credits must be carried out by issuing a full credit and re-bill. Choosing the document level option will also provide faster tax transaction processing in most situations since fewer messages are exchanged with the Vertex tax software.</p> <p>The <i>Line Level</i> option allows more flexibility when issuing credits and returns, but prevents you from taking advantage of maximum tax rules at the invoice or multiline level. This option should be chosen when it is not an acceptable practice to issue a full invoice credit and re-bill when an individual line must be credited.</p>
Tax Supplier Call – Payables	Select how tax calculation transactions from the Accounts Payable application are sent to Vertex. Transactions from Purchasing are always sent line by line, regardless of the value in this field.
Tax Supplier Call – Sales	Select how tax calculation transactions from the Billing application are sent to Vertex. Transactions from Order Management that are fully paid at sales order entry time also use this value; otherwise, they will always be sent line by line.
Tax Supplier Upgrade Status	Displays the status of the process run when the tax supplier application is changed. The process updates the geocodes associated with addresses in PeopleSoft.
Message Node Name	Set to the node setup for the exchange of messages between the PeopleSoft Integration Broker and the Vertex O Series web service. By default, the node to use is <i>PSFT_TAX</i> .

<i>Field or Control</i>	<i>Description</i>
Tax Exemption Override Allowed	Select to allow tax exempt transactions to be sent from PeopleSoft to Vertex. If tax exemption overrides are not allowed, exemptions must be maintained within the Vertex application.

Testing the Vertex O Series Integration

To test the Vertex O Series integration, click the **Test Tax Install** button on the Tax Provider Installation page. The system will send a test transaction to Vertex and should report a Geocode and nonzero tax amount. If an error message appears or the tax amount is zero, then there is a problem with the tax installation that must be corrected.

Integrating With Vertex Q Series

Understanding PeopleSoft Business Interlinks to Vertex Q Series

PeopleSoft delivers two business interlink objects to interact with Vertex for both online and batch transactions: VERTEX_CALCTAX and VERTEX_GEOCODES. The business interlink objects communicate with Vertex Q Series through an interlink plug-in provided by Vertex. The interlink plug-in file name is `psbivrtx.dll` and it must be installed in the interface drivers directory.

Note: PeopleSoft Business Interlink is a deprecated product. These options currently exist for upgrade compatibility and transition.

UNIX Environments

In UNIX environments, the business interlink algorithmically converts the file name format from that of a Windows DLL to that of a UNIX shared library or shared object. The business interlink adds the prefix *lib* to the name, and replaces the extension, *DLL*, with the appropriate extension for the current UNIX platform.

For example, the business interlink changes the file name `psbivrtx.dll` to `libpsbivrtx.sl` before each call to the interlink plug-in.

PeopleTools: PeopleCode API Reference

Identifying Vertex Q Series Plug-in Locations

By default, the PeopleSoft system searches for the interlink plug-in in the interface drivers directory, as described in the following table:

Location	Mode
<code><PS_HOME>\bin\client \winx86\interfacedrivers</code>	For two-tier testing on Windows.
<code><PS_HOME>\bin\server \winx86\interfacedrivers</code>	For Windows application server and PeopleSoft Process Scheduler server.
<code><PS_HOME>/bin/interfacedrivers</code>	For UNIX application server and PeopleSoft Process Scheduler server.

These directories also contain the XML script files that describe the interlink plug-in structure which were used to create the delivered business interlink objects in the PeopleSoft system. The XML script files have

the same name as the Windows DLL plug-in, except that the .XML extension is used instead of the .DLL extension.

When you purchase the Vertex software, Vertex provides an interlink plug-in that you must place in these directories. The copy under the Windows directory <PS_HOME>\bin\client\winx86\InterfaceDrivers is not used in production. The PeopleSoft Process Scheduler server and the application server use the plug-in copy in <PS_HOME>\bin\server\winx86\InterfaceDrivers on Windows, or <PS_HOME>/bin/interfacedrivers on UNIX.

Application Server Configurations

The application server configuration file has the following entry, which you can use to change the plug-in default location:

```
[PSTOOLS]
=====
; General settings for PSTOOLS
=====
;Uncomment this to specify an alternate directory to search for Interface Drivers.
;Business Interlink Driver Directory=
```

Process Scheduler Configurations

The PeopleSoft Process Scheduler configuration file contains the following entry, which you can use to change the plug-in default location:

```
;-----
;Uncomment to specify an alternate directory to search for Interface Drivers.
;Business Interlink Driver Directory=
```

Identifying Vertex Q Series DLLs and Shared Library Locations

Vertex-supplied DLLs or shared libraries can be placed in the following locations:

Note: Refer to the Vertex documentation for more information.

Windows NT

Typically, the Vertex DLLs should be placed in the same directory as the PeopleSoft main executable file:

<i>Location</i>	<i>Mode</i>
<PS_HOME>\bin\client\winx86	For two-tier testing on Windows.
<PS_HOME>\bin\server\winx86	For Windows application server and PeopleSoft Process Scheduler server.

UNIX

Typically, the Vertex shared libraries should be placed in the same directory with the other PeopleSoft libraries. This directory is `<PS_HOME>/bin`. It is usually one of the directories pointed to by the `LIBPATH` environment variable set up in the `psconfig.sh` UNIX shell script.

If the system cannot find either the plug-in DLL/shared library or Vertex DLLs/shared libraries, an interlink connectivity error appears.

Setting Up Variables for the Vertex Database Location

This section discusses how to:

- Set up Vertex on a Microsoft Windows NT or Windows 2000 platform.
- Set up Vertex on a UNIX platform.

Setting Up Vertex on a Microsoft Windows NT or Windows 2000 Platform

Vertex provides a registry file to populate entries in the Microsoft Windows NT or Windows 2000 registry. A typical file contains the following entries:

This example illustrates the fields and controls on the Vertex registry file. You can find definitions for the fields and controls later on this page.

ab] (Default)	REG_SZ	(value not set)
ab] DebugLog	REG_SZ	c:\vertex30\debug
ab] DebugOn	REG_SZ	FALSE
ab] GeoDBDataSrc	REG_SZ	c:\vertex30\geocodes
ab] GeoDBPassword	REG_SZ	
ab] GeoDBServer	REG_SZ	
ab] GeoDBUser	REG_SZ	
ab] JurisNames	REG_SZ	
ab] RateDBDataSrc	REG_SZ	c:\vertex30\rates
ab] RateDBPassword	REG_SZ	
ab] RateDBServer	REG_SZ	
ab] RateDBUser	REG_SZ	
ab] RegDBDataSrc	REG_SZ	c:\vertex30\register
ab] RegDBPassword	REG_SZ	
ab] RegDBServer	REG_SZ	
ab] RegDBUser	REG_SZ	
ab] StatsOn	REG_SZ	FALSE
ab] TDMCacheAgeLimit	REG_SZ	3600
ab] TDMCacheSize	REG_SZ	16
ab] TDMCaseSense	REG_SZ	FALSE
ab] TDMDBDataSrc	REG_SZ	c:\vertex30\tdm
ab] TDMDBPassword	REG_SZ	
ab] TDMDBServer	REG_SZ	
ab] TDMDBUser	REG_SZ	
ab] UseTDM	REG_SZ	Y
ab] VVersion	REG_SZ	

For a Vertex ISAM database, provide values for xxxDBDataSrc. The value would be the directory containing the Vertex database. For relational database connection, the typical setup is to provide values for xxxDBServer, xxxDBPassword, and xxxDBUser, as follows:

```
RateDBDataSrc=
RateDBServer=qsu
RateDBPassword=solaris25
RateDBUser=solaris25
GeoDBDataSrc=
GeoDBServer=qsu
GeoDBUser=solaris25
GeoDBPassword=solaris25
RegDBDataSrc=
RegDBServer=qsu
RegDBUser=solaris25
RegDBPassword=solaris25
TDMDataSrc=
TDMDBServer=qsu
TDMDBUser=solaris25
TDMDBPassword=solaris25
```

There should be no blanks between the equal sign and the parameter entered.

See the Vertex Softlink documentation for additional information.

Setting Up Vertex on a UNIX Platform

Vertex provides a configuration file called `PSVTXCFG` that contains similar entries to the ones in a Microsoft Windows registry. This file must be accessible to the Vertex-supplied shared libraries. Define an environment variable called `PSVTXCFG` in `psconfig.sh`, and assign it the location of the configuration file. Define the variable for both the application server and PeopleSoft Process Scheduler so that the variable can be used by the Vertex software.

Setting Up PeopleSoft Installation Options for Vertex Q Series

The Set Up Financials/Supply Chain, Install, Tax Provider Installation page provides one option for Vertex Q Series: **Using TDM**. Although PeopleSoft applications as delivered do not currently support this option, it is included in case you want to configure it to work with your business processes. Set up the **Using TDM** (using Tax Decision Maker) option in your Vertex environment settings. Use of TDM is set up in the Vertex registry on a Windows NT platform and in `PSVTXCFG.SH` on a UNIX platform.

Note: To display options for Vertex Q Series, *Vertex* must be chosen as the **Tax Supplier** on the Overall Installation Options page and *Vertex Q Series* as the **Vertex Tax Application** on the Tax Provider Installation page.

Testing the Vertex Q Series Installation

To test the Vertex Q Series installation, click the **Test Tax Install** button on the Tax Provider Installation page. The system will send a test transaction to Vertex and should report a Geocode and nonzero tax amount. If an error message appears or the tax amount is zero, then there is a problem with the tax installation that must be corrected.

Troubleshooting Installation Errors

The sections discuss error messages that you may receive and suggestions for resolving the errors. For batch processing, similar error messages are placed in the message log of each failed process.

Two-Tier Testing, Interlink Tester With Plug-in or Vertex DLLs Not Accessible

This message appears:

This example illustrates the fields and controls on the Cannot load plug-in error message. You can find definitions for the fields and controls later on this page.

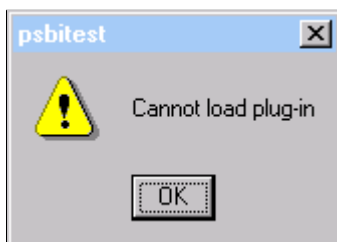

Check the client directories to ensure the plug-in and the Vertex DLLs are in the correct directories. Check the Vertex documentation for a complete list of required DLLs. This error may also be related to changes that you make to the Configuration Manager to change the location of the default interlink directory.

Three-Tier Geocode Look-Up With the Interlink Plug-in Not Accessible

Check the directories on the computer running the application server and ensure that the plug-in and the Vertex DLLs are in the correct directories. Check the Vertex documentation for a complete list of required DLLs. This error may also be related to changes that you make to the Configuration Manager to change the location of the default interlink directory. Also check permissions of the plug-in and Vertex shared libraries.

Three-Tier Where the Vertex Open Fails on Geocode Look-Up

This error message appears when the Vertex software detects invalid Vertex database pointers, permissions issues or other open failures:

This example illustrates the fields and controls on the Vertex error message. You can find definitions for the fields and controls later on this page.



Check the Microsoft Windows registry or Vertex UNIX configuration file PSVTXCFG to ensure entries are pointing to the correct locations. For a UNIX installation, ensure that the variable PSVTXCFG is defined in psconfig.sh, pointing to the directory that contains the PSVTXCFG file. Additionally, check for permissions problems.

Integrating With Taxware Enterprise

Understanding PeopleSoft Integration With Taxware Enterprise

PeopleSoft communicates with Taxware Enterprise through the PeopleSoft Integration Broker. To integrate with the Taxware Enterprise tax solution, you must perform the following configuration steps:

1. Set up your local integration gateway and load the gateway connectors.

The Integration Broker uses the HTTPTARGET connector to communicate with Taxware Enterprise.

See *PeopleTools: Integration Broker*, Managing Integration Gateways.

2. Activate the TAX_INTEGRATION service operation queue.
3. Activate the service operations and routings:

- GET_GEOCODE_REQ
- DO_TAXCALC_REQ

See Managing Service Operations, *PeopleTools: Integration Broker*

See Managing Routing Definitions, *PeopleTools: Integration Broker*

4. Activate the PSFT_TAX node.
5. Set Taxware as the **Tax Supplier** on the PeopleSoft Financials/Supply Chain Installation Options page and set the appropriate Taxware Enterprise options on the Tax Provider Installation page.

See [Setting Up PeopleSoft Installation Options for Taxware Enterprise](#).

Note: When you switch from one Tax Supplier Application to another, such as switching from Taxware Sales and Use Tax to Taxware Enterprise, any geocodes associated with address records in the PeopleSoft database must be upgraded before tax calculations can be sent to the tax supplier software. The Tax Provider Installation page will display the geocode upgrade process status. You should run the process, allow it to complete successfully, or fix any errors that occur, before proceeding.

6. Configure Billing, Order Management, and Purchasing business units to calculate sales and use taxes through a tax supplier and set business-unit level tax supplier options.

See [Setting Up Third-Party Tax Solutions](#).

Configuring Taxware Enterprise Integration

This section discusses how to activate the TAX_INTEGRATION service operation queue, activate the service operations, activate the routings, and activate the PSFT_TAX node.

Pages Used to Configure Taxware Enterprise Integration

<i>Page Name</i>	<i>Definition Name</i>	<i>Usage</i>
Queue Definitions Page	IB_QUEUEDEFN	Activate the TAX_INTEGRATION service operation queue.
Service Operation - General Page	IB_SERVICE	Activate the service operations.
Service Operations - Routings Page	IB_SERVICETRNGS	Activate the routings.
Node Definitions Page	IB_NODE	Activate tax node .

Queue Definitions Page

Use the Queue Definitions page (IB_QUEUEDEFN) to activate the TAX_INTEGRATION service operation queue.

Navigation:

PeopleTools > Integration Broker > Integration Setup > Queues

For the TAX_INTEGRATION queue, verify that **Queue Status** is *Run*.

Service Operation - General Page

Use the Service Operation - General page (IB_SERVICE) to activate the service operations.

Navigation:

PeopleTools > Integration Broker > Integration Setup > Service Operations

PeopleSoft delivers service operations in PeopleSoft Integration Broker with a default status of *Inactive*. You must activate each service operation before attempting to send or receive data from a third-party source, such as Taxware. To setup a service operation use the information in the table below.

<i>Service Operation</i>	<i>Direction and Type</i>	<i>Handlers</i>	<i>Chunking Available?</i>	<i>Integrates With</i>
GET_GEOCODE_REQ	Outbound Synchronous		No	Third-party system, for example Taxware Enterprise

Service Operation	Direction and Type	Handlers	Chunking Available?	Integrates With
DO_TAXCALC_REQ	Outbound Synchronous		No	Third-party system, for example Taxware Enterprise

See [Setting Up Service Operations](#).

See *PeopleTools: Integration Broker*

Service Operations - Routings Page

Activate the Service Operations - Routings page.

Activate the DO_TAXCALC_REQ and the GET_GEOCODE_REQ routings for the PSFT_TAX node.

- For the DO_TAXCALC_REQ routing, set the **Value** field of the PrimaryURL property to the endpoint of the tax software's tax calculation request function.

Typically this will be: `http://HOST:PORT/taxwareServlet/servlet/TaxwareAdapter`. Replace *HOST:PORT* with the address of the Taxware Enterprise adapter.

- For the GET_GEOCODE_REQ routing, set the **Value** field of the PrimaryURL property to the endpoint of the tax software's geocode request function.

Typically this will be: `http://HOST:PORT/taxwareServlet/servlet/TaxwareAdapter`. Replace *HOST:PORT* with the address of the Taxware Enterprise adapter.

See [Manage Routing Definitions](#), *PeopleTools: Integration Broker*

Node Definitions Page

Use the Node Definitions page (IB_NODE) to activate tax node .

Navigation:

PeopleTools, Integration Broker, Integration Setup, Nodes

Verify that the PSFT_TAX node is active.

See [Adding and Configuring Nodes](#), *PeopleTools: Integration Broker*

Setting Up PeopleSoft Installation Options for Taxware Enterprise

The Set Up Financials/Supply Chain, Install, Tax Provider Installation page provides the following options for Taxware Enterprise:

Note: To display options for Taxware Enterprise, *Taxware* must be chosen as the **Tax Supplier** on the Overall Installation Options page and *Taxware Enterprise* as the **Taxware Tax Application** on the Tax Provider Installation page.

Field or Control	Description
Tax Supplier Call Options	<p>Select whether taxes rules will be applied to individual lines or to an entire invoice. The options are:</p> <ul style="list-style-type: none"> • <i>Doc Level</i>: apply tax rules to entire invoices. • <i>Line Level</i>: apply tax rules line-by-line. <p>The <i>Doc Level</i> option allows you to take advantage of invoice and multiline maximum tax rules in some jurisdictions, but when you choose the <i>Doc Level</i> option, returns and credits must be carried out by issuing a full invoice credit and re-bill.</p> <p>The <i>Line Level</i> option allows more flexibility when issuing credits and returns, but prevents you from taking advantage of maximum tax rules at the invoice or multiline level. This option should be chosen when it is not an acceptable practice to issue a full invoice credit and re-bill when an individual line must be credited.</p>
Tax Supplier Call – Payables	<p>Select how tax rules are applied when sales and use tax liabilities are calculated in the Accounts Payable application. Tax rules on transactions from Purchasing are always applied line by line, regardless of the value in this field.</p>
Tax Supplier Call – Sales	<p>Select how tax calculation transactions from the Billing application are sent to Taxware. Transactions from Order Management that are fully paid at sales order entry time also use this value; otherwise, they will always be sent line by line.</p>
Tax Supplier Upgrade Status	<p>Displays the status of the process run when the tax supplier application is changed. The process updates the geocodes associated with addresses in PeopleSoft.</p>
Message Node Name	<p>Set to the node setup for the exchange of messages between the PeopleSoft Integration Broker and Taxware Enterprise. Typically, the node name is <i>PSFT_TAX</i>.</p>
Tax Exemption Override Allowed	<p>Allows tax exemption certificates to be maintained in PeopleSoft. If tax exemption overrides are not allowed, exemptions must be maintained within the Taxware application.</p>

Testing the Taxware Enterprise Integration

To test the Taxware Enterprise integration, click the **Test Tax Install** button on the Tax Provider Installation page. Enter the organization code defined in Taxware Enterprise in the box that appears. The system will send a test transaction to Taxware and should report a Geocode and nonzero tax amount. If an error message appears or the tax amount is zero, then there is a problem with the tax installation that must be corrected.

Chapter 19

Integrating with Taxware Sales and Use Tax

Understanding PeopleSoft Business Interlinks to Taxware Sales and Use Tax

PeopleSoft delivers two business interlink objects to interact with Taxware for both online and batch transactions: TAXWARE_CALCTAX and TAXWARE_GEOCODES. The business interlink objects communicate with Taxware Sales and Use Tax Series through an interlink plug-in provided by Taxware. The interlink plug-in file name is `pstwlink.dll` and it must be installed in the interface drivers directory.

Note: PeopleSoft Business Interlink is a deprecated product. These options currently exist for upgrade compatibility and transition.

UNIX Environments

In UNIX environments, the business interlink algorithmically converts the file name format from that of a Windows DLL to that of a UNIX shared library or shared object. The business interlink adds the prefix *lib* to the name, and replaces the extension, *DLL*, with the appropriate extension for the current UNIX platform.

For example, the business interlink changes the file name `pstwlink.dll` to `libpstwlink.sl` before each call to the interlink plug-in.

PeopleTools: PeopleCode API Reference

Identifying Taxware Plug-in Locations

By default, the PeopleSoft system searches for the interlink plug-in in the interface drivers directory, as described in the following table:

Location	Mode
<code><PS_HOME>\bin\client \winx86\interfacedrivers</code>	For two-tier testing on Windows.
<code><PS_HOME>\bin\server \winx86\interfacedrivers</code>	For Windows application server and PeopleSoft Process Scheduler server.
<code><PS_HOME>/bin/interfacedrivers</code>	For UNIX application server and PeopleSoft Process Scheduler server.

These directories also contain the XML script files that describe the interlink plug-in structure which were used to create the delivered business interlink objects in the PeopleSoft system. The XML script files have the same name as the Windows DLL plug-in, except that the .XML extension is used instead of the .DLL extension.

When you purchase the Taxware software, Taxware provides the interlink plug-in that you must place in these directories. The copy under the Windows directory <PS_HOME>\bin\client\winx86\InterfaceDrivers is not used in production. The PeopleSoft Process Scheduler server and the application server use the plug-in copy in <PS_HOME>\bin\server\winx86\InterfaceDrivers on Windows, or <PS_HOME>/bin/interfacedrivers on UNIX.

Application Server Configurations

The application server configuration file has the following entry, which you can use to change the plug-in default location:

```
[PSTOOLS]
=====
; General settings for PSTOOLS
=====
;Uncomment this to specify an alternate directory to search for Interface Drivers.
;Business Interlink Driver Directory=
```

Process Scheduler Configurations

The PeopleSoft Process Scheduler configuration file contains the following entry, which you can use to change the plug-in default location:

```
;-----
;Uncomment to specify an alternate directory to search for Interface Drivers.
;Business Interlink Driver Directory=
```

Identifying Taxware DLLs and Shared Library Locations

Taxware-supplied DLLs or shared libraries can be placed in the following locations:

Note: Refer to the Taxware documentation for more information.

Windows NT

Typically, the Taxware DLLs should be placed in the same directory as the PeopleSoft main executable file:

<i>Location</i>	<i>Mode</i>
<PS_HOME>\bin\client\winx86	For two-tier testing on Windows.
<PS_HOME>\bin\server\winx86	For Windows application server and PeopleSoft Process Scheduler server.

UNIX

Typically, the Taxware shared libraries should be placed in the same directory with the other PeopleSoft libraries. This directory is `<PS_HOME>/bin`. It is usually one of the directories pointed to by the `LIBPATH` environment variable set up in the `psconfig.sh` UNIX shell script.

If the system cannot find either the plug-in DLL/shared library or Taxware supplied DLL/shared library, an interlink connectivity error appears.

Setting Up Variables for the Taxware Database Location

This section discusses how to:

- Set up Taxware on a Microsoft Windows NT or Windows 2000 platform.
- Set up Taxware on a UNIX platform.

Setting Up Taxware on a Microsoft Windows NT or Windows 2000 Platform

Taxware provides three INI files that you need to set up to point to the location of the Taxware database directories:

- `AVPTAX.INI`
- `AVPSTEP.INI`
- `AVPZIP.INI`

Place all three files in the `WINNT` directory. Each file contains a set of pointer variables that you should point to the location where the Taxware database files were placed during Taxware software installation.

Note: Taxware opens the database files in read/write mode, even when only reading from them. You may encounter problems with permissions.

Setting Up Taxware on a UNIX Platform

You must set up several environment variables with the location of the Taxware database files. Taxware provides a script called `ENVARS` that contains all the variables that need to be defined. In `ENVARS`, provide values for these variables, and then run the `ENVARS` script when starting the application server and PeopleSoft Process Scheduler. A typical place to run the `ENVARS` script is in `psconfig.sh`.

Note: Taxware opens the database files in read/write mode. Consequently, you may encounter problems with permissions.

Setting Up PeopleSoft Installation Options for Taxware Sales and Use Tax

The Set Up Financials/Supply Chain, Install, Tax Provider Installation page provides the following options for Taxware Sales and Use Tax:

Note: To display these options, *Taxware* must be chosen as the **Tax Supplier** on the Overall Installation Options page and *Taxware Sales and Use Tax* as the **Taxware Tax Application** on the Tax Provider Installation page.

<i>Field or Control</i>	<i>Description</i>
Using STEP	Select this option if you use the Taxware STEP module.
Reason Code Matching	<p>Select one of two options to determine how you want to handle tax certificate entry reason lookup in STEP.</p> <p><i>Only Exact Reason Code Match:</i> This is the more restrictive option. Taxware finds only tax certificates that were entered with the exact reason code you set up on the bill line. If you select this option, you must add the Taxware reason codes as translate values for the field TAX_EXEMPT_RC. Only add those reason codes you expect to be sent to PeopleSoft.</p> <p><i>Use Default Record:</i> Taxware looks for an exact match. If it doesn't find one, it uses a default tax certificate for exemption.</p>
Certificate Level	<p>Enter an option that determines which taxing jurisdiction level tax certificates apply.</p> <p>Selecting <i>Individual Certificate Levels</i> enables STEP to look for certificates at all individual levels and exempt tax only for those levels at which a certificate is found.</p> <p>Selecting <i>State Level Only</i> prompts STEP to look for certificates at the state level only.</p>

Testing the Taxware Sales and Use Tax Installation

To test the Taxware Sales and Use Tax installation, click the **Test Tax Install** button on the Tax Provider Installation page. The system will send a test transaction to Taxware and should report a Geocode and nonzero tax amount. If an error message appears or the tax amount is zero, then there is a problem with the tax installation that must be corrected.

Troubleshooting Installation Errors

The sections discuss error messages that you may receive and suggestions for resolving the errors. For batch processing, similar error messages are placed in the message log of each failed process.

Two-Tier Testing, Interlink Tester With Plug-in or Supplier DLL Not Accessible

This message appears:

This example illustrates the fields and controls on the Cannot load plug-in error message. You can find definitions for the fields and controls later on this page.

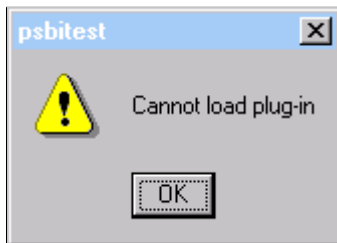

Check the client directories to ensure the plug-in and the Taxware DLLs are in the correct directories. Check the Taxware documentation for a complete list of required DLLs. This error may also be related to changes that you make to the Configuration Manager to change the location of the default interlink directory.

Three-Tier Geocode Look-up With the Interlink Plug-in Not Accessible

Check the directories on the computer running the application server and ensure that the plug-in and the Taxware DLLs are in the correct directories. Check the Taxware documentation for a complete list of required DLLs. This error may also be related to changes that you make to the Configuration Manager to change the location of the default interlink directory. Also check permissions of the plug-in and Supplier DLLs.

Three-Tier Where the Taxware Open Fails on Geocode Look-up

This error message appears when the Taxware software detects invalid database pointers, permissions issues or other open failures:

This example illustrates the fields and controls on the Tax Supplier error message. You can find definitions for the fields and controls later on this page.



Check the INI files or UNIX `psconfig.sh` environment variables to ensure that entries are pointing to the correct locations. Additionally, you should check for permissions problems.

Scenarios for Integration With PeopleSoft Supply Chain Management

Understanding This Troubleshooting

EIP setup and processing is similar for EIPs of the same design pattern, so you can use this information and apply it to other EIPs. Examples for the most commonly used SCM EIPs are also provided. In this section, setting up and processing the following EIPs are discussed:

- Sales Order Load
- Sales Order Acknowledgement
- Purchase Order Dispatch
- Advanced Shipment Notice
- Billing Invoice

See [Setting Up Service Operations](#).

See [PeopleSoft SCM Inbound EIPs](#).

See [PeopleSoft SCM Outbound EIPs](#).

<i>EIP</i>	<i>Description</i>
Sales Order	Loads sales orders.
Sales Order Acknowledgement	Sends message acknowledging receipt of sales order.
Purchase Order Dispatch	Purchase order dispatched to a Supplier using the Publish Outbound Message process
Advanced Shipping Notice	Notifies customers that their sales orders have been shipped using the Publish Outbound Message process.
Billing Invoice	Invoice sent out to a customer using the Publish Outbound Message process.

Note: The real-life scenarios described within this documentation may not conform to the business rules and procedures within your organization. These scenarios should not be construed as consulting or implementation advice for your specific industry or your individual organization. The information here should be adapted or even disregarded based on the needs of your organization. PeopleSoft does not guarantee that the information included here will work as intended within your customized environment.

Common Elements Used

<i>Field or Control</i>	<i>Description</i>
Asynchronous	Messages that do not require a response. These messages are sent to the destination system as one-way messages, and are used for publish and subscribe messages where there may be a lapse in time between the message being sent and received.
Batch Publish	Use this design pattern to publish messages from a batch application. The batch application can be a COBOL or Structured Query Report program that takes either a procedural or set-based approach, or it can be an Application Engine set-based program.
Batch Subscribe	This design pattern enables you to perform edits against messages in sets. This can be a useful technique for high volume data, including millions of inbound rows. This design pattern is useful when you know that a single message definition may contain multiple instances of a transaction, or when you must reuse an existing batch program.
Component Publish	In this design pattern, the transaction or setup data that you want to send out of PeopleSoft is being updated by using a PeopleSoft component. In this case, the data is already in the component buffer, and the Publish PeopleCode function is used to publish a message.
Full Table Publish	Use this design pattern to populate an entire copy of a table onto a remote database or legacy system. Generally, full data replication occurs with setup tables, or relatively static, low-volume tables that are keyed by SetID. When a copy of a table exists on the remote system, incremental updates can be used.
Full Table Subscribe	Use this design pattern to subscribe to messages that contain an entire copy of a table that is published from a remote database or legacy system. Generally, full data replication occurs with setup tables, or relatively static, low-volume tables that are keyed by SetID. When a copy of a table exists on the remote system, incremental updates can be used.
Synchronous	Occurring or existing at the same time. Used for messages that are sent out and receive an immediate response.

Example: Setting Up the Sales Order Load EIP

This section discusses the Sales Order Load EIP.

Page Used to Set Up the Sales Order Load EIP

<i>Page Name</i>	<i>Definition Name</i>	<i>Usage</i>
Service Operations-General Page	IB_SERVICE	Define and activate a service operation.
Service Operations-Handlers Page	IB_SERVICEHDLR	Activate one or more service operation handlers.
Service Operations-Routings Page	IB_SERVICERTNGS	Define and activate routing definitions on the service operation.
Queue Definitions Page	IB_QUEUEDEFN	Activate the queue used by the service operation.
Routings-Parameters Page	IB_ROUTINGDEFNDOC	Verify the external service alias name, nodes, and transform programs used by this routing.
Node Definitions Page	IB_NODE	Activate node used by the service operation.
Inbound File Loader Rules Page	PSIBINFILERULE	Establish inbound file rules to load sales order data from a flat file using an EDI X.12 850 format.
File Inbound Page	EO_FILE_INBOUND	Establish inbound file rules to load sales order data from a flat file not using an EDI format.

Understanding the Sales Order Load EIP

The Sales Order Load EIP is an asynchronous inbound service operation used to load sales orders from a third-party into PeopleSoft Order Management. The Sales Order Load EIP meets EDI requirements of the X.12 850 transaction set.

Before you can receive sales orders using with the Sales Order Load EIP, you must:

<i>Type of Setup</i>	<i>Steps</i>
Complete application setup	None for this message.

Type of Setup	Steps
Complete Integration Broker setup	<ul style="list-style-type: none"> • Activate the SALES_ORDER_LOAD service operation. • Verify the queue is in run mode. • Activate the handler. • Activate the routing. • Confirm the parameters of the routing definition. • Verify the node is active. • Define rules to load EDI flat files.
Complete Enterprise Component setup	Define rules to load flat files not using an EDI format.

Service Operations-General Page

Use the PeopleSoft Integration Broker to activate the SALES_ORDER_LOAD service operations.

Use the Service Operations-General page (IB_SERVICE) to define and activate a service operation.

Navigation:

PeopleTools, Integration Broker, Integration Setup, Service Operations, General

This example illustrates the fields and controls on the Service Operations-General page. You can find definitions for the fields and controls later on this page.

The screenshot shows the 'Service Operations-General' page with the following details:

- General Tab:**
 - Service Operation: SALES_ORDER_LOAD
 - Operation Type: Asynchronous - One Way
 - *Operation Description: Sales Order Load
 - Operation Comments: [Text Area]
 - Owner ID: Order Management
 - Operation Alias: [Text Field]
 - *Req Verification: None
 - User/Password Required:
 - Service Operation Security: [Link]
- Default Service Operation Version:**
 - *Version: VERSION_1
 - Version Description: Sales Order Load
 - Version Comments: [Text Area]
 - Default: Active:
 - Runtime Schema Validation:
 - Request Message:
 - Non-Repudiation:
 - Routing Status:

Routing Status	Exists
Any-to-Local	Exists
Local-to-Local	Does not exist
Local-to-Atom	Does not exist
 - Routing Actions Upon Save:
 - Regenerate Any-to-Local:
 - Generate Local-to-Local Warning: Regenerating sets all routing field values to their initial state.
- Message Information:**
 - Type: Request
 - Message.Version: SALES_ORDER_LOAD.VERSION_1
 - *Queue Name: SALES_ORDER_LOAD
 - View Message: [Link]
 - View Queue: [Link]
 - Add New Queue: [Link]
- Buttons:** Save, Return to Service, Add Version

For the SALES_ORDER_LOAD service operation, select the Active check box for the applicable service operation version. If the desired version is not the default version for the service operation, the default version must also be activated.

If the inbound sales order data is a flat file using the EDI format X.12 850, then you must activate the EDI_TXN_850 service operation in addition to the SALES_ORDER_LOAD service operation.

On the General tab of the Service Operations component, select the View Queue link at the bottom of the page to access the Queue Definitions page.

PeopleTools: Integration Broker

Queue Definitions Page

Use the Queue Definitions page (IB_QUEUEDEFN) to activate the queue used by the service operation.

Navigation:

- PeopleTools, Integration Broker, Integration Setup, Service Operations, General. Select the Queue link attached to this service operation.

- PeopleTools, Integration Broker, Integration Setup, Queues

This example illustrates the fields and controls on the Queue Definitions page. You can find definitions for the fields and controls later on this page.

Queue Definitions

Queue Name SALES_ORDER_ACKNOWLEDGEMENT

Description Sales Order Outbound Channel

Comments Message Channel for Sales Order Outbound Messages

Archive Unordered

Queue Status Pause

Owner ID Order Management

Operations Assigned to Queue

Service	Version
SALES_ORDER_ACKNOWLEDGEMENT	VERSION_2
SALES_ORDER_ACKNOWLEDGEMENT	VERSION_1
SALES_ORDER_ACKNOWLEDGEMENT	VERSION_3
SALES_ORDER_CHANGE_NOTICE	VERSION_3
SALES_ORDER_CHANGE_NOTICE	VERSION_1
SALES_ORDER_CHANGE_NOTICE	VERSION_2
SALES_QUOTE_NOTICE	VERSION_2
SALES_QUOTE_NOTICE	VERSION_3
SALES_QUOTE_NOTICE	VERSION_1

Define Partitioning Fields

Common Fields	Field	Alias Name
<input type="checkbox"/>	SETID	
<input type="checkbox"/>	CUST_ID	
<input type="checkbox"/>	BUSINESS_UNIT	
<input type="checkbox"/>	ORDER_NO	
<input type="checkbox"/>	SOURCE_CD	
<input type="checkbox"/>	BUSINESS_UNIT_PC	
<input type="checkbox"/>	IN_PROCESS_FLG	
<input type="checkbox"/>	PROCESS_INSTANCE	
<input type="checkbox"/>	AUDIT_ACTN	
<input type="checkbox"/>	OPERATIONNAME	

Save

Add Field

For the SALES_ORDER_LOAD queue, verify the Queue Status field has a value of *Run*.

Click the Return button to go back to the Service Operations component.

Service Operations-Handlers Page

Use the Service Operations-Handlers page (IB_SERVICEHDLR) to activate one or more service operation handlers.

Navigation:

PeopleTools, Integration Broker, Integration Setup, Service Operations, Handlers

This example illustrates the fields and controls on the Service Operations-Handlers page. You can find definitions for the fields and controls later on this page.

General
Handlers
Routings

Service Operation SALES_ORDER_LOAD

Default Version VERSION_1

Operation Type Asynchronous - One Way

Handlers				
*Name	*Type	Sequence	*Implementation	*Status
1 SalesOrderLoad	On Notify		Application Class	Inactive Details + -

For the SALES_ORDER_LOAD service operation, click the Handlers tab of the Service Operations component. Select the value of *Active* in the Status field for the SalesOrderLoad handler.

Service Operations-Routings Page

Use the Service Operations-Routings page (IB_SERVICERTNGS) to define and activate routing definitions on the service operation.

Navigation:

PeopleTools, Integration Broker, Integration Setup, Service Operations, Routings

This example illustrates the fields and controls on the Service Operations-Routings page. You can find definitions for the fields and controls later on this page.

Selected	Name	Version	Operation Type	Sender Node	Receiver Node	Direction	Status	Results
<input type="checkbox"/>	SALES_ORDER_LOAD_EDJ_850	VERSION_1	Asynch	~~ANY~~	PV920DVL	Inbound	Inactive	
<input type="checkbox"/>	SALES_ORDER_LOAD	VERSION_1	Asynch	~~ANY~~	PV920DVL	Inbound	Inactive	

For the SALES_ORDER_LOAD service operation, click the Routings tab of the Service Operations component. Activate an inbound routing definition for each sender node and external alias name that will be permitted to send in sales order data. In this example, both delivered routings permit data to be sent from any valid node, but each routing has a unique external alias and purpose. To activate a routing, select the check box next to the routing definition and click the Activate Selected Routings button. There are two delivered routing definitions:

- The SALES_ORDER_LOAD routing definition is used to receive inbound sales order data using an XML format.
- The SALES_ORDER_LOAD_EDJ_850 routing definition is used to receive inbound sales order data using the EDI X.12 850 transaction format and transform the data to the standard PeopleSoft format for sales orders.

Select the link attached to the routing definition name to access the Routings component and confirm the routing definition parameters.

Routings-Parameters Page

Use the Routings-Parameters page (IB_ROUTINGDEFNDOC) to verify the external service alias name, nodes, and transform programs used by this routing.

Navigation:

- PeopleTools, Integration Broker, Integration Setup, Service Operations, Routings. Select the link attached to the routing definition name, then select the Parameters tab.
- PeopleTools, Integration Broker, Integration Setup, Routings, Parameters

This example illustrates the fields and controls on the Routings- Parameters page. You can find definitions for the fields and controls later on this page.

IB Routing Definitions

Routing Definitions
Parameters
Routing Properties

Routing Name SALES_ORDER_LOAD_EDI_850

Service Operation SALES_ORDER_LOAD

Service Operation Version VERSION_1

Sender Node ~~ANY~~

Receiver Node PV920DVL

Parameters

Type Inbound Request

External Alias

Alias References

Message.Ver into Transform 1

Transform Program 1

Transform Program 2

Message.Ver out of Transforms

Save
Return

Routing Definitions | Parameters | Routing Properties

On the Routings tab of the Service Operations component, select the link attached to the routing definition name. This link accesses the Routing Definitions component. Select the Parameters tab and complete the following steps:

1. Confirm the external alias name in the External Alias field for the routing is correct. When sending or receiving data, the Integration Broker determines which routing to use by referring to the external alias name, not the routing name.
2. Add or change the transform programs on this routing definition. A routing definition defines the sending and receiving nodes for a transaction and specifies any inbound and outbound transformations to invoke. A transform program is a type of PeopleSoft Application Engine program that can convert data from one format to another; for example, from XML to a flat file. Use a transform program when one node sends a request or response message with a data structure different from the structure required by the other node. You must decide, based on your environment, to change, remove, or add transform programs. The SALES_ORDER_LOAD_EDI_850 routing definition is delivered with the transform program, EDI_850_I, to convert incoming data from the EDI X.12 850 transaction format to the standard PeopleSoft format for sales orders. If you are not using EDI then you will want to use the SALES_ORDER_LOAD routing definition instead.

Node Definitions Page

Use the Node Definitions page (IB_NODE) to activate node used by the service operation.

Navigation:

PeopleTools, Integration Broker, Integration Setup, Nodes, Node Definitions

This example illustrates the fields and controls on the Node Definitions page. You can find definitions for the fields and controls later on this page.

Verify the Active Node check box has been selected for any nodes used in the routings that you activated on the Service Operations-Routings page for SALES_ORDER_LOAD service operation. If the routings are from "ANY" node, verify each node you plan to integrate from is active.

Inbound File Loader Rules Page

Use the Inbound File Loader Rules page (PSIBINFILERULE) to establish inbound file rules to load sales order data from a flat file using an EDI X.

12 850 format.

Navigation:

PeopleTools > Integration Broker > File Utilities > Inbound File Loader Rules

This example illustrates the fields and controls on the Inbound File Loader Rules page. You can find definitions for the fields and controls later on this page.

Inbound File Loader Rules

File Identifier: EDI_TXN_840

Processing Options

***Inbound File:**

File Type

Data File

Index File

File Layout ID:

***Status:** ▼

Message Options

Replace Data

Publish From: 🔍

Alternate Processing

Root Package ID: 🔍

Path: 🔍

Class Name: 🔍

Post-Processing

Program Name: 🔍

Section: 🔍

File Layout Mappings Personalize | Find | View All | 📄 | 📅

Sequence	*Definition Name	*Service Operation	
1	<input type="text" value="EDI_TXN_840"/> 🔍	<input type="text" value="EDI_TXN_840"/> 🔍	+ -

First ◀ 1 of 1 ▶ Last

For inbound flat file data using the EDI X.12 850 format, configure and activate the inbound file loader rule within PeopleSoft Integration Broker.

File Inbound Page

Use the File Inbound page (EO_FILE_INBOUND) to establish inbound file rules to load sales order data from a flat file not using an EDI format.

Navigation:

Enterprise Components > Integration Definitions > Inbound File Rule

This example illustrates the fields and controls on the File Inbound page. You can find definitions for the fields and controls later on this page.

The screenshot displays the 'File Inbound' configuration page. The fields and their values are as follows:

- File Identifier:** SCM_INBOUND_EDI
- *Inbound File:** C:\Temp\Scm_inbound_index.txt
- *Status:** Inactive
- File Layout ID:** 998
- LUW Size:** (empty)
- Program Name:** (empty)
- Section:** (empty)
- Index Flag:**
- Create Message Header:**
- Create Message Trailer:**

At the bottom, there is a table titled 'File Layout' with the following data:

File Layout		Personalize	Find	View All	First	1 of 11	Last
*Definition Name	*Message Name						
1	ADVANCED_SHIPPING_RECEIPT						

For inbound flat files that are not using the EDI X.12 850 format, configure and activate the inbound file rule within the PeopleSoft Enterprise Components menu.

1. Adding the **Definition Name** of *SALES_ORDER*, and **Message Name** of *SALES_ORDER_LOAD*.
2. Confirming that the Status field is set to *Active*.

Note: If the file identified in the Inbound File field is an index file, as shown in the page shot above, then the index file lists the names of a set of data files to be processed. Each line of the index file must reference a plain text file using a file name with full directory path information. The wildcards * and ? may be used only in the file name and not in the directory path.

Example: Processing the Sales Order Load EIP

This section discusses how you process inbound sales orders.

Pages Used to Process Sales Orders Load EIP

<i>Page Name</i>	<i>Definition Name</i>	<i>Usage</i>
<u>Inbound File Processing Page</u>	PSIBFILERUNCNTL	Launch this process to load sales order data from a flat file using an EDI X.12 850 format. The data is loaded into PeopleSoft's staging tables.
<u>Inbound File Page</u>	EO_FILETOMSG	Launch this process to bring sales order data in a non-EDI flat file (EDI X.12 850 format) into PeopleSoft's inbound staging tables.
<u>Electronic Commerce Page</u>	RUN_OM_EC	Launch this process to load inbound sales order data from the inbound staging tables to the PeopleSoft production tables.
<u>Data Def Maint Page</u>	EO_EIP_CTL_MAINT	View data detail or correct errors for inbound sales order transactions.
Error Summary Page	OM_EIP_ORDERS	View the error queue for inbound sales order data that failed to load into the PeopleSoft production tables.
<u>Order Completion Page</u>	RUN_OM_BACKGRND	Run the Order Completion process to complete processing for the request for all inbound sales order data.

Inbound File Processing Page

Use the Inbound File Processing page (PSIBFILERUNCNTL) to launch this process to load sales order data from a flat file using an EDI X.

12 850 format. The data is loaded into PeopleSoft's staging tables.

Navigation:

PeopleTools > Integration Broker > File Utilities > Inbound File Processing

This example illustrates the fields and controls on the Inbound File Processing page. You can find definitions for the fields and controls later on this page.

For inbound flat file data using the EDI X.12 850 format, use the Inbound File Processing run control page to launch the Application Engine process PTIB_INFILE that initiates the file-to-message processing. The file-to-message processing function reads the file and publishes it as a message.

Field or Control	Description
File Identifier	Select or enter the name of the file identifier that you set up in the Inbound File Loader Rules page. The file identifier is tied to the publish rules.
Index Flag	A read-only field that indicates if the file being processed is an index file or a data file. When checked, the Inbound File Loader utility is processing an index file.
File Layout ID	A read-only field that displays the file layout ID associated with the file in the Inbound File Loader Rules page.
Inbound File	A read-only field that displays the name of the file being processed.

PeopleTools: Integration Broker

Inbound File Page

Use the Inbound File page (EO_FILETOMSG) to launch this process to bring sales order data in a non-EDI flat file (EDI X).

12 850 format) into PeopleSoft's inbound staging tables.

Navigation:

Enterprise Components > Integration Definitions > Initiate Processes > Inbound File Publish

This example illustrates the fields and controls on the Inbound File process page. You can find definitions for the fields and controls later on this page.

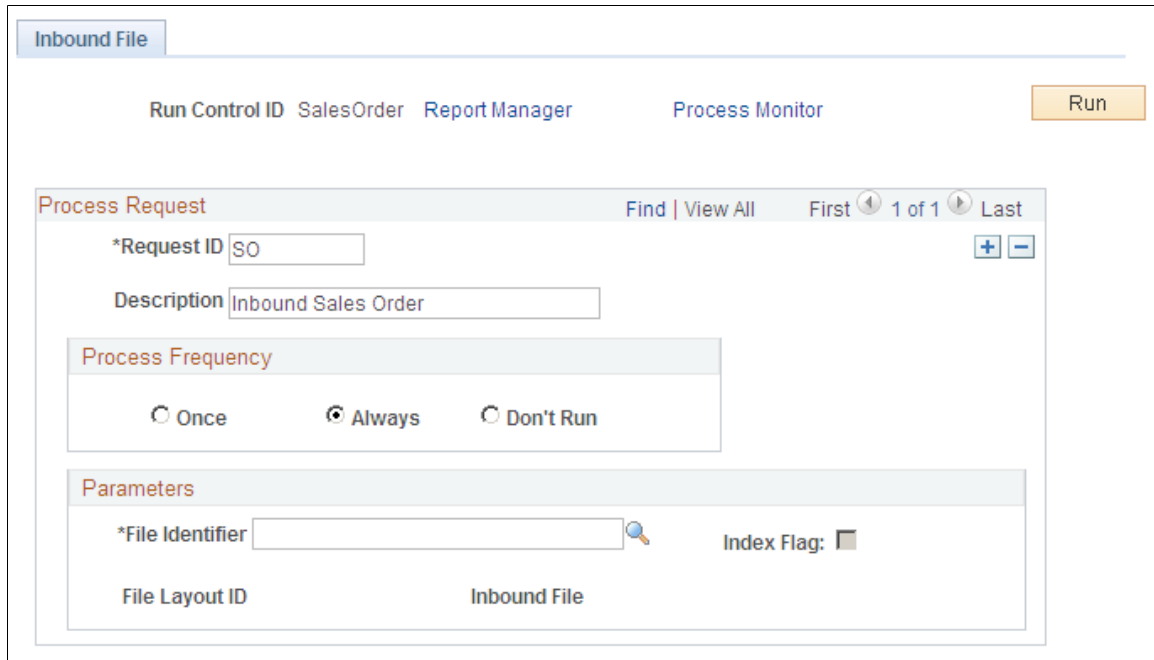

For inbound flat file data not using the EDI format, use the Inbound File run control page to launch an Application Engine process that initiates the file-to-message processing. The file-to-message processing function reads the file and publishes it as a message.

Electronic Commerce Page

Use the Electronic Commerce page (RUN_OM_EC) to launch this process to load inbound sales order data from the inbound staging tables to the PeopleSoft production tables.

Navigation:

Order Management > Electronic Commerce > Process Staged Orders and RFQs

This example illustrates the fields and controls on the Electronic Commerce page. You can find definitions for the fields and controls later on this page.

Process Staged Orders/RFQs

Run Control ID SalesOrders Report Manager Process Monitor Run

Process Instance: 14679

Delete Staging Records

Process Request Parameters Personalize | Find | View All |

First ◀ 1 of 1 ▶ Last

Business Unit	Transaction Type	EIP Control ID	Source Code
US001	PO	1653645435956907000000001	+ -

Post Process Options

- Run Order Completion
- Run Hold Checking
- Run Credit Checking
- Run Populate Demand
- Run Reservations

The Electronic Commerce process (OM_EC) is part of the overall inbound electronic commerce flow and is the process that takes sales orders that are loaded in the staging tables and validates the fields that are on the record to insure that the values are correct. The process performs these steps:

- Edits the data, such as customer numbers and units of measure, to ensure that they are valid.
- Converts the customer's product or item number to a PeopleSoft product identifier, when a PeopleSoft product identifier is not provided.
- Assigns PeopleSoft order numbers.
- Sets system defaults and status flags.
- Validates data changes to ensure that they are valid.
- Loads data into the production order tables (order staging data that is found to have errors is not loaded into the production tables until the errors are resolved).

Related Links

"Running Electronic Commerce for Inbound Sales Orders and Quote EIPs" (PeopleSoft Order Management)

Data Def Maint Page

Use the Data Def Maint (Data Definition Maintenance) page (EO_EIP_CTL_MAINT) to view data detail or correct errors for inbound sales order transactions.

Navigation:

SCM Integrations > Transaction Error Handling > Transaction Error Data Defn

This example illustrates the fields and controls on the Data Definition Maintenance page. You can find definitions for the fields and controls later on this page.

The screenshot shows the 'Data Def Maint' page. At the top, there are search filters: 'Transaction Type' set to 'PO', 'Inbound Sales Order - 850', 'Grid Select' set to 'Staged', 'SetID', 'Unit', 'Reference', and 'Status'. A 'Search' button is located to the right. Below the filters is a 'Stage Table Data' section with tabs for 'Stage Data', 'Reference', 'Publish Data', 'Date Time', and 'Process Instance'. The 'Stage Data' tab is active, showing a table with columns: Status, EIP Control ID, Transaction Type, Description, and User. The table contains three rows of data.

	Status	EIP Control ID	Transaction Type	Description	User
1	Error	3000000000005167000000001	PO	Inbound Sales Order - 850	SAMPLE
2	Complete	3000000000000126000000001	PO	Inbound Sales Order - 850	SAMPLE
3	Error	1653645435956907000000001	PO	Inbound Sales Order - 850	VP1

Use the Data Definition Maintenance page to view the status of the transaction. Select a **Transaction Type** of *PO*. Enter a business **Unit**. Click the **Search** button.

Click the Details icon to access the Error Summary page where you can view and correct errors.

This example illustrates the fields and controls on the Error Summary page. You can find definitions for the fields and controls later on this page.

The screenshot shows the 'Correct Order/RFQ Errors' page. It displays transaction details: 'Transaction Type PO', 'EIP Control ID 1653645435956907000000001', and 'Status Error'. Below this is an 'Error Queue' section with tabs for 'Field Properties', 'Edit Properties', and 'Additional Information'. The 'Field Properties' tab is active, showing a table with columns: Field Name and Record. The table lists three error records.

	Field Name	Record
1	CARRIER_ID	ORD_HEADER_EC
2	STATE	ORD_ADDR_EC
3	TEXT80	ORD_CDATA_EC

At the bottom of the page, there are navigation links: 'Header', 'Line', 'Schedule', 'Addresses', 'Notes', 'User Defined Reference', and 'Data Definition Maintenance'.

Navigate to the Header, Line, Schedule, Addresses, Notes, or User Defined References to fix errors.

Related Links

"Understanding Sales Order and Quotation EIPs in PeopleSoft Order Management" (PeopleSoft Order Management)

[Data Def Maint Page](#)

Order Completion Page

Use the Order Completion page (RUN_OM_BACKGRND) to run the Order Completion process to complete processing for the request for all inbound sales order data.

Navigation:

Order Management > Quotes and Orders > Process Orders > Order Completion

This example illustrates the fields and controls on the Order Completion page. You can find definitions for the fields and controls later on this page.

Order Completion

Run Control ID Complete Report Manager Process Monitor Run

Process Request Parameters

From Business Unit <input type="text"/>	To Business Unit <input type="text"/>
From Order Number <input type="text"/>	To Order No <input type="text"/>
From Order Date <input type="text"/>	To Order Date <input type="text"/>
From Order Group <input type="text"/>	To Order Group <input type="text"/>
From Customer ID <input type="text"/>	To Customer ID <input type="text"/>
From Source Code <input type="text"/>	To Source Code <input type="text"/>

Post Process Options

- Run Hold Checking
- Run Credit Checking
- Run Populate Demand
- Run Reservations

The Order Completion/Repricing process (OM_BACKGRND) completes processing for sales orders that are entered into PeopleSoft Order Management by several methods, including flat file and XML messages. Completing this process enables you to access the orders from the Order Entry Form component.

Enter the selection criteria, and click **Run**.

Related Links

"Running Order Completion/Repricing" (PeopleSoft Order Management)

Example: Setting Up the Sales Order Acknowledgement EIP

This section discusses the Sales Order Acknowledgement EIP.

Pages Used to Set Up the Sales Order Acknowledgement EIP

<i>Page Name</i>	<i>Definition Name</i>	<i>Usage</i>
<u>Contact Page</u>	CONTACT	Maintain information about each contact.
Contact Customer Page	CONTACT_CUST_PAGE	Indicate the primary ship to contact.
Contact Additional Info Page	CONTACT_ADDTL_INFO	Enter the preferred communication method for the selected document.
<u>Service Operations-General Page</u>	IB_SERVICE	Define and activate a service operation.
<u>Service Operations-Handlers Page</u>	IB_SERVICEHDLR	Activate one or more service operation handlers.
<u>Service Operations-Routings Page</u>	IB_SERVICERTNGS	Define and activate routing definitions on the service operation.
<u>Routings-Parameters Page</u>	IB_ROUTINGDEFNDOC	Verify the external service alias name, nodes, and transform programs used by this routing.
<u>Queue Definitions Page</u>	IB_QUEUEDEFN	Activate the queue used by the service operation.
<u>Node Definitions Page</u>	IB_NODE	Activate node used by the service operation.
<u>Nodes-Connectors Page</u>	IB_NODECONN	For an outbound service operation, verify the node is connected to the correct network.
<u>Batch Publish Rules Page</u>	EO_MSGPUBATCH	Set up publication rules. You must activate a publish rule for the publication messages you create to follow. This rule includes instructions on message chunking, if necessary.
<u>Customer ID Chunk Page</u>	OM_CHUNKCUSTID	Set up chunking by customer for the batch publish rule.

Understanding the Sales Order Acknowledgment EIP

The Sales Order Acknowledgement EIP is an asynchronous outbound service operation to send an acknowledgement to your customers that a sales order has been received. The data from this service operation is passed to a third-party system or to PeopleSoft CRM. The Sales Order Acknowledgement EIP meets EDI requirements of the X.12 855 transaction set.

Before you can send order acknowledgements with the Sales Order Acknowledgement EIP, you must:

Type of Setup	Steps
Complete application setup	Associate customers receiving sales order acknowledgements with an <i>ACKN</i> document code and a preferred communication value of <i>XML Only</i> or <i>XML and Print</i> . If PeopleSoft Order Management is installed, you set up these values on the Contact Additional Info page in the Maintain Contact component.
Complete Integration Broker setup	<ul style="list-style-type: none"> • Activate the SALES_ORDER_ACKNOWLEDGEMENT service operation. • Verify the queue is in run mode. • Activate the handler. • Activate the routing. • Confirm the parameters of the routing definition. • Verify the node is active.
Complete Enterprise Component setup	<ul style="list-style-type: none"> • Activate the associated batch publish rule and specify the appropriate output for the message (an XML-based message or a flat file). If you are using message chunking, select a chunking rule ID. • If you are using message chunking, set up the chunking rule mapping definitions.

Related Links

[Setting Up Service Operations](#)

[Understanding POU Supplier Systems](#)

[Understanding SRS Applications](#)

Contact Page

Use the Contact page (CONTACT) to maintain information about each contact.

Navigation:

Customers >Create Customer Contacts

You must ensure that the customer you are interacting with has a contact set up to accept EDI transmissions, and that the contact is a ship to contact.

This example illustrates the fields and controls on the Contact page. You can find definitions for the fields and controls later on this page.

Use the Contact Customer page (CONTACT_CUST_PAGE) to indicate the primary ship to contact.

Navigation:

Click the **Contact Customer Information** link on the Contact page.

This example illustrates the fields and controls on the Contact Customer page. You can find definitions for the fields and controls later on this page.

Customer SetID	Customer ID	Customer Name	Location	Credit Cards	Documentation	Primary Bill To	Primary Ship To	Primary Sold To	Staffing Hot List
SHARE	0000050037	Mercy Medical Center of Pleasanton	Main	Credit Cards	Documentation	<input checked="" type="checkbox"/>	<input checked="" type="checkbox"/>	<input checked="" type="checkbox"/>	<input type="checkbox"/>

Select the **Primary Ship To** check box to receive the proper shipping notifications.

Under the **Documentation** link, make sure the **Document Code** is *ACKN* (order acknowledgement), and **Preferred Communication** is *XML & Print* or *XML Only*.

This example illustrates the fields and controls on the Documentation page. You can find definitions for the fields and controls later on this page.

Contact Customers

Documentation

Contact SetID SHARE Contact ID 10 Name Jeffreys,Jenny
Customer SetID SHARE Customer ID 1002 Name Easy Solutions
Effective Date 01/01/1990

Documentation		Personalize Find View All	First 1-2 of 2 Last
*Document Code	*Preferred Communication	Number of Copies	
<input type="text"/>	<input type="text" value="Email & Print"/>	<input type="text" value="1"/>	<input type="button" value="+"/> <input type="button" value="-"/>
ACKN	<input type="text" value="XML only"/>	1	<input type="button" value="+"/> <input type="button" value="-"/>

Related Links

"Understanding Contact Information" (PeopleSoft Order to Cash Common Information)

Service Operations-General Page

Use the PeopleSoft Integration Broker to activate the Sales Order Acknowledgement service operation.

Use the Service Operations-General page (IB_SERVICE) to define and activate a service operation.

Navigation:

PeopleTools, Integration Broker, Integration Setup, Service Operations, General

This example illustrates the fields and controls on the Service Operations-General page (1 of 2). You can find definitions for the fields and controls later on this page.

The screenshot shows the 'General' tab of the Service Operations-General page. The main form contains the following fields and controls:

- Service Operation:** SALES_ORDER_ACKNOWLEDGEMENT
- Operation Type:** Asynchronous - One Way
- *Operation Description:** Sales Order Acknowledgement
- Operation Comments:** (Empty text area)
- Owner ID:** Order Management (Dropdown menu)
- Operation Alias:** (Empty text field)
- Service Operation Security:**
 - User/Password Required
 - *Req Verification:** None (Dropdown menu)
- Default Service Operation Version:**
 - *Version:** VERSION_3
 - Version Description:** Sales Order Acknowledgement
 - Version Comments:** (Empty text area)
 - Runtime Schema Validation:**
 - Request Message
 - Non-Repudiation
 - Routing Status:**
 - Default
 - Active
 - Any-to-Local: Does not exist.
 - Local-to-Local: Does not exist.
 - Local-to-Atom: Does not exist.
 - Routing Actions Upon Save:**
 - Generate Any-to-Local
 - Generate Local-to-Local
- Message Information:**
 - Type:** Request
 - Message.Version:** SALES_ORDER_ACKNOWLEDGEMENT (with search icon) [View Message](#)
 - *Queue Name:** SALES_ORDER_ACKNOWLEDGEMENT (with search icon) [View Queue](#) [Add New Queue](#)

This example illustrates the fields and controls on the Service Operations-General page (2 of 2). You can find definitions for the fields and controls later on this page.

Non-Default Versions		
Version	Description	Active
VERSION_1	Sales Order Acknowledgement	<input type="checkbox"/>
VERSION_2	Sales Order Acknowledgement	<input type="checkbox"/>

Below the table are buttons for [Save](#), [Return to Service](#), and [Add Version](#). The top right of the table area includes navigation links: Personalize | Find | First | 1-2 of 2 | Last.

For the SALES_ORDER_ACKNOWLEDGEMENT service operation, select the Active check box for the applicable service operation version. If the desired version is not the default version for the service operation, the default version must also be activated.

On the General tab of the Service Operations component, select the View Queue link at the bottom of the page to access the Queue Definitions page.

Service Operation Versions

The Default Service Operation Version group box displays the most current version of this service operation. If there have been changes to the PeopleSoft application that have required the service

operation to change, for example new fields or tables, then the Non-Default Versions group box displays any older versions of the service operation based on the older release of the PeopleSoft application. The default version is always the current version, however you can use a non-default version to communicate with third-party systems that want to receive the data based on an old version. Select the link in the Non-Default Versions box to access the Service Operation Version page. This page contains information about the non-default version, including message and queue. In addition, the Logical Transforms group box contains transforms to convert the data to or from the default version. A transform program is a type of PeopleSoft Application Engine program that can convert data from one format to another. Based on your environment, you will review and possibly change these transforms.

PeopleTools: Integration Broker

Queue Definitions Page

Use the Queue Definitions page (IB_QUEUEDEFN) to activate the queue used by the service operation.

Navigation:

- PeopleTools, Integration Broker, Integration Setup, Service Operations, General. Select the Queue link attached to this service operation.
- PeopleTools, Integration Broker, Integration Setup, Queues

This example illustrates the fields and controls on the Queue Definitions page. You can find definitions for the fields and controls later on this page.

Queue Definitions

Queue Name: SALES_ORDER_ACKNOWLEDGEMENT

Description:

Comments:

Archive Unordered

Queue Status:

Owner ID:

Operations Assigned to Queue

Service Operations	Version
SALES_ORDER_ACKNOWLEDGEMENT	VERSION_2
SALES_ORDER_ACKNOWLEDGEMENT	VERSION_1
SALES_ORDER_ACKNOWLEDGEMENT	VERSION_3
SALES_ORDER_CHANGE_NOTICE	VERSION_3
SALES_ORDER_CHANGE_NOTICE	VERSION_1
SALES_ORDER_CHANGE_NOTICE	VERSION_2
SALES_QUOTE_NOTICE	VERSION_2
SALES_QUOTE_NOTICE	VERSION_3
SALES_QUOTE_NOTICE	VERSION_1

Define Partitioning Fields

Common Fields	Field	Alias Name
<input type="checkbox"/>	SETID	<input type="text"/>
<input type="checkbox"/>	CUST_ID	<input type="text"/>
<input type="checkbox"/>	BUSINESS_UNIT	<input type="text"/>
<input type="checkbox"/>	ORDER_NO	<input type="text"/>
<input type="checkbox"/>	SOURCE_CD	<input type="text"/>
<input type="checkbox"/>	BUSINESS_UNIT_PC	<input type="text"/>
<input type="checkbox"/>	IN_PROCESS_FLG	<input type="text"/>
<input type="checkbox"/>	PROCESS_INSTANCE	<input type="text"/>
<input type="checkbox"/>	AUDIT_ACTN	<input type="text"/>
<input type="checkbox"/>	OPERATIONNAME	<input type="text"/>

For the SALES_ORDER_ACKNOWLEDGEMENT queue, verify the Queue Status field has a value of *Run*.

Click the Return button to go back to the Service Operations component.

Service Operations-Handlers Page

Use the Service Operations-Handlers page (IB_SERVICEHDLR) to activate one or more service operation handlers.

Navigation:

PeopleTools, Integration Broker, Integration Setup, Service Operations, Handlers

This example illustrates the fields and controls on the Service Operations-Handlers page. You can find definitions for the fields and controls later on this page.

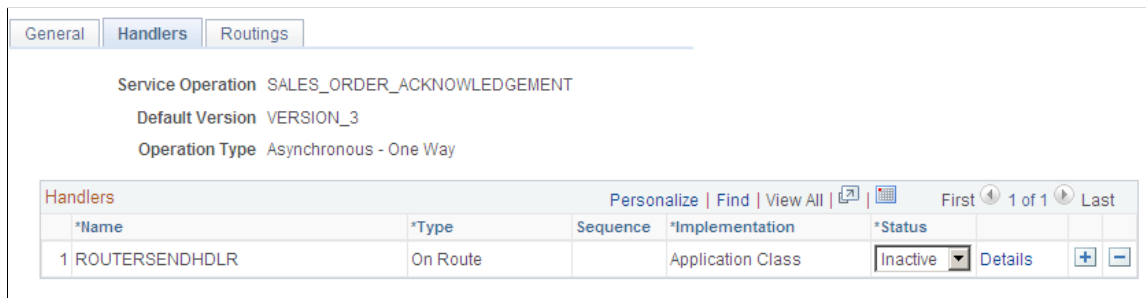

For the SALES_ORDER_ACKNOWLEDGEMENT service operation, click the Handlers tab of the Service Operations component. If you want to use chunking, select the value of *Active* in the Status field for the OnRoute handler.

Service Operations-Routings Page

Use the Service Operations-Routings page (IB_SERVICERTNGS) to define and activate routing definitions on the service operation.

Navigation:

PeopleTools, Integration Broker, Integration Setup, Service Operations, Routings

This example illustrates the fields and controls on the Service Operations-Routings page. You can find definitions for the fields and controls later on this page.

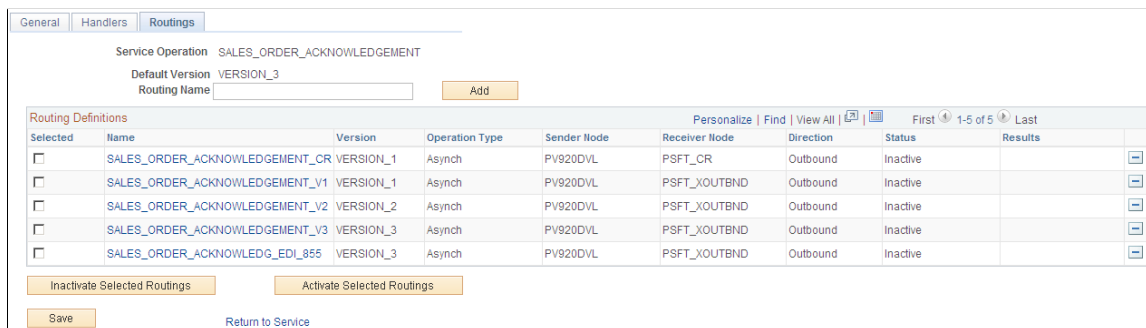

For the SALES_ORDER_ACKNOWLEDGEMENT service operation, click the Routings tab of the Service Operations component. Activate an outbound routing definition for each receiver node and external alias name that data will be sent to. To activate a routing, select the check box next to the routing definition and click the Activate Selected Routings button. The following routing definitions are predefined:

- The SALES_ORDER_ACKNOWLEDG_EDI_855 routing definition sends outbound sales order acknowledgements using the EDI X.12 855 format as a flat file. The data is converted from the PeopleSoft standard XML format to the EDI X.12 855 transaction format and then from XML to a flat file. If you wish to send the data as an XML file using the EDI X.12 855 format, then alter the routing definition to remove the second transform program.
- The SALES_ORDER_ACKNOWLEDGEMENT_CR routing definition sends outbound sales order acknowledgements using the PeopleSoft standard XML format to PeopleSoft CRM.
- The SALES_ORDER_ACKNOWLEDGEMENT_V1 routing definition sends outbound sales order acknowledgements using the PeopleSoft standard XML format and converts the data from the current service operation version (version 2) to an older version (version 1) of the service operation. This routing definition is used when you are sending data to a third-party system that is still using an older version of the service operation.
- The SALES_ORDER_ACKNOWLEDGEMENT_V2 routing definition sends outbound sales order acknowledgements using the PeopleSoft standard XML format. This routing definition is used when you are sending data to a third-party system that is using the current version of the service operation.

Note: You do not need to select a routing definition if the batch publish rule is set up to post to a flat file only.

Routings-Parameters Page

Use the Routings-Parameters page (IB_ROUTINGDEFNDOC) to verify the external service alias name, nodes, and transform programs used by this routing.

Navigation:

- PeopleTools, Integration Broker, Integration Setup, Service Operations, Routings. Select the link attached to the routing definition name, then select the Parameters tab.
- PeopleTools, Integration Broker, Integration Setup, Routings, Parameters

This example illustrates the fields and controls on the Routings-Parameters page. You can find definitions for the fields and controls later on this page.

The screenshot displays the 'IB Routing Definitions' interface with the 'Parameters' tab selected. The routing name is 'SALES', the service operation is 'SALES_ORDER_ACKNOWLEDGEMENT', and the service operation version is 'VERSION_3'. The 'Parameters' section includes an 'External Alias' field, a 'Message.Ver into Transform 1' field with the value 'SALES_CRM_ORDER_LOAD.VERSION_1', and two 'Transform Program' fields. The 'Message.Ver out of Transforms' field is also present. 'Save' and 'Return' buttons are located at the bottom of the form.

On the Routings tab of the Service Operations component, select the link attached to the routing definition name. This link accesses the Routing Definitions component. Select the Parameters tab and complete the following steps:

1. Confirm the external alias name in the External Alias field for the routing is correct. When sending or receiving data, the Integration Broker determines which routing to use by referring to the external alias name, not the routing name.
2. Verify or change the transform programs on this routing definition. A routing definition defines the sending and receiving nodes for a transaction and specifies any inbound and outbound transformations to invoke. A transform program is a type of PeopleSoft Application Engine program that can convert data from one format to another; for example, from XML to a flat file. Use a transform program when one node sends a request or response message with a data structure different from the structure required by the other node. You must decide, based on your environment, to change, remove, or add transform programs. The SALES_ORDER_ACKNOWLEDG_ED1_855 routing definition is delivered with two transform programs. The ED1_855_O transform program converts outbound sales order acknowledgements from the standard PeopleSoft XML format to the EDI X.12 855 transaction format (still in XML). The XML_TO_FILE transform program converts the EDI X.12 855 formatted data from XML to a flat file format. You can remove the XML_TO_FILE transform program to send your data in the XML EDI X.12 855 format. If you are not using EDI then you will want to use the SALES_ORDER_ACKNOWLEDGEMENT_V2 routing definition instead.

The transform program, to convert data from the current version of a service operation to an older version, is located on the Service Operation Version page of the non-default version. Select the non-default version on the Service Operations-General page to access the Service Operation Version page.

Node Definitions Page

Use the Node Definitions page (IB_NODE) to activate node used by the service operation.

Navigation:

PeopleTools, Integration Broker, Integration Setup, Nodes, Node Definitions

This example illustrates the fields and controls on the Node Definitions page. You can find definitions for the fields and controls later on this page.

The screenshot displays the 'Node Definitions' page in PeopleTools. The page has a navigation bar with tabs for 'Node Definitions', 'Connectors', 'Portal', 'WS Security', and 'Routings'. The main form contains the following fields and controls:

- Node Name:** PSFT_XOUTBND
- *Description:** External Outbound node
- *Node Type:** External (dropdown menu)
- *Authentication Option:** None (dropdown menu)
- *Default User ID:** VP1
- WSIL URL:** (empty text field)
- Hub Node:** (empty text field)
- Master Node:** (empty text field)
- Company ID:** (empty text field)
- IB Throttle Threshold:** (empty text field)
- Image Name:** (empty text field)
- Codeset Group Name:** (empty text field)
- External User ID:** (empty text field)
- External Password:** (empty text field)
- External Version:** (empty text field)

On the right side of the form, there are three buttons: 'Copy Node', 'Rename Node', and 'Delete Node'. Below the form, there are two links: 'Contact/Notes' and 'Properties'. At the bottom left, there is a 'Save' button.

Verify the Active Node check box has been selected for any nodes used in the routings that you activated on the Service Operations-Routings page for SALES_ORDER_ACKNOWLEDGEMENT service operation.

Nodes-Connectors Page

Access the Nodes-Connectors page (PeopleTools, Integration Broker, Integration Setup, Nodes, Connectors).

This example illustrates the fields and controls on the Nodes-Connectors page. You can find definitions for the fields and controls later on this page.

The screenshot shows the 'Nodes-Connectors' page with the following details:

- Node Name: PSFT_XOUTBND
- Gateway ID: LOCAL
- Connector ID: PSFTTARGET
- *Delivery Mode: Guaranteed Delivery
- Message: PeopleSoft Nodes are configured via the Gateway Setup Properties
- Warning: This connector does not have properties. Use Gateways Page to setup.
- Buttons: Ping Node, Save

For an outbound service operation, verify the node or routing is connected to the correct network using the Gateway ID and Connector ID fields. Depending on the file output location, you may need a password. If a password is needed, you should use the password encryption utility on this page.

Note: Your database administrator will need to assist you with this setup.

Batch Publish Rules Page

Access the Batch Publish Rules page (Enterprise Components, Integration Definitions, Batch Publish Rules).

This example illustrates the fields and controls on the Batch Publish Rules page. You can find definitions for the fields and controls later on this page.

The screenshot shows the 'Batch Publish Rules' page with the following details:

- Service Operation: SALES_ORDER_ACKNOWLEDGEMENTService Operation
- Operation Description: Sales Order Acknowledgement
- Message.Version: SALES_ORDER_ACKNOWLEDGEMENT.VERSION_3
- Publish Rule Definition: SALES_ORDER_ACK_CUSTOMER_ID
- *Description: Sales Order Acknowledgement
- *Status: Inactive
- Chunking Rule ID: (empty)
- Alternate Chunk Table: (empty)
- Message Options:
 - Create Message Header
 - Create Message Trailer
- Output Format:
 - Message
 - Flat File
 - Flat File with Control Record

For the SALES_ORDER_ACKNOWLEDGEMENT message name (service operation):

1. Select *Active* **Status** to activate this publish rule definition.
2. Select the appropriate **Output Format**. The PeopleSoft Application Engine program can create either an Extensible Markup Language (XML) message that flows through PeopleSoft Integration Broker architecture or a flat file generated on the PeopleSoft Process Scheduler server and not published elsewhere.
3. If you want to use message chunking, configure a chunking rule and then enter it in the **Chunking Rule ID** field.

Customer ID Chunk Page

Access the Customer ID Chunk page (SCM Integrations, Chunking Rule, CustID to Node Mapping).

This example illustrates the fields and controls on the Customer ID Chunk page. You can find definitions for the fields and controls later on this page.

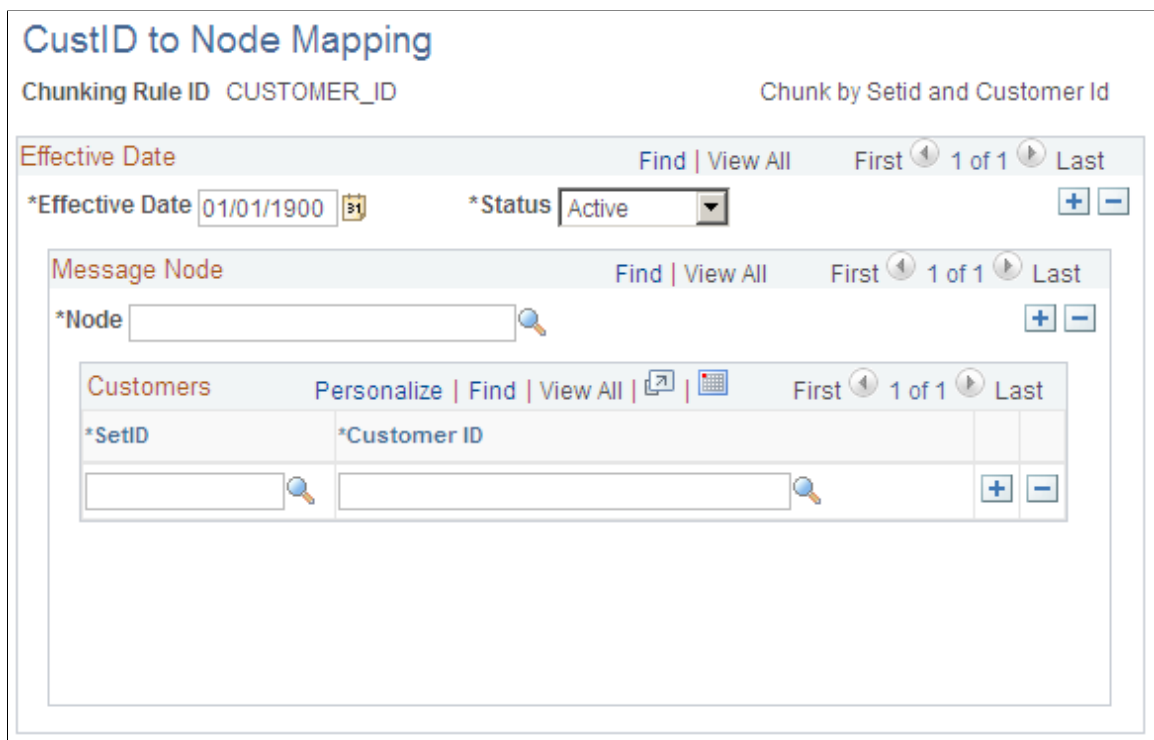

If using chunking for the batch publish rule, set up the chunking rule mapping definitions. You can use a delivered chunking rule or create a new chunking rule.

If using the CUSTOMER_ID chunking rule ID, access the Customer ID Chunk page.

Select the node for each customer that receives electronic data.

Chunking is only needed if you have requirements to break up the outbound data and send them to different destinations based on attributes in the message such as business unit or customer ID. For example, use chunking to send a single customer's messages to a specific node setup for that trading partner. If you are using a middleware product to actually determine trading partner destinations then

a single transaction with all trading partner transactions can usually be sent directly to the middleware product. You would not need to activate message chunking in this situation.

Related Links

[Setting Up Chunking](#)

Example: Processing the Sales Order Acknowledgement EIP

This section discusses processing the Sales Order Acknowledgement EIP.

Pages Used to Process the Sales Order Acknowledgement EIPs

<i>Page Name</i>	<i>Definition Name</i>	<i>Usage</i>
Publish Outbound Message Page	IN_RUN_PUB_MSG	Initiate the outbound message publish process for outbound SCM messages that use the batch publish design pattern.
Order Acknowledgement Message Selection Criteria Page	OM_RUN_OUTBOUND_EC	Enter processing options for the Sales Order Acknowledgement outbound messages. You can select processing options for only one message at a time.

Publish Outbound Message Page

Use the Publish Outbound Message page (IN_RUN_PUB_MSG) to initiate the outbound message publish process for outbound SCM messages that use the batch publish design pattern.

Navigation:

SCM Integrations > Publish Outbound Message

This example illustrates the fields and controls on the Publish Outbound Message page. You can find definitions for the fields and controls later on this page.

Publish Outbound Message

Run Control ID Publish Report Manager Process Monitor **Run**

Language English

Inventory Messages

- Balance Notification
- Advanced Shipping Notices
- Interunit Expected Receipts
- Internal Location Exp Receipts
- Item Status Change
- TMS Order Release
- GTIN Data Notification
- VMI Interunit Expected Receipt

Purchasing Messages

- Request for Quotation
- Purchase Order Dispatch
- Return To Vendor (Supplier)
- PO Expected Receipts

Order Management Messages

- Sales Order Acknowledgement
- Sales Order Change Notice
- Sales Quote Notice
- Product Price List
- Sales Order/Quote Status

Manufacturing Messages

- Production Order Update
- Item Revision
- Replenish Request Dispatch

Billing Messages

- Billing Invoice Notice

Supplier Contract Management

- Supplier Contract Syndication

Click the **Sales Order Acknowledgement** check box, and click the **Sales Order Acknowledgement** link to access the Order Acknowledgement Message Selection Criteria page.

This example illustrates the fields and controls on the Order Acknowledgement Message Selection Criteria page. You can find definitions for the fields and controls later on this page.

Order Acknowledgment Message Selection Criteria

Run Control ID Publish Report Manager Process Monitor **Run**

Language English

Select Processing Parameters

Business Unit

Source Code

*Request ID

Description

Outbound Messages Selected

- Order Acknowledgement Queue
- Order Change Notice Queue
- Quote Notice Queue

OK **Cancel**

Example: Setting Up the Purchase Order Dispatch EIP

This section discusses setting up the Purchase Order Dispatch EIP.

Pages Used to Set Up the Purchase Order Dispatch EIP

<i>Page Name</i>	<i>Definition Name</i>	<i>Usage</i>
<u>PO Header Details Page</u>	PO_HDR_DTL	Enter or change PO header information online.
<u>Service Operations-General Page</u>	IB_SERVICE	Define and activate a service operation.
<u>Service Operations-Handlers Page</u>	IB_SERVICEHDLR	Activate one or more service operation handlers.
<u>Service Operations-Routings Page</u>	IB_SERVICERTNGS	Define and activate routing definitions on the service operation.
<u>Routings-Parameters Page</u>	IB_ROUTINGDEFNDOC	Verify the external service alias name, nodes, and transform programs used by this routing.
<u>Queue Definitions Page</u>	IB_QUEUEDEFN	Activate the queue used by the service operation.
<u>Node Definitions Page</u>	IB_NODE	Activate node used by the service operation.
<u>Nodes-Connectors Page</u>	IB_NODECONN	For an outbound service operation, verify the node is connected to the correct network.
<u>Batch Publish Rules Page</u>	EO_MSGPUBATCH	Set up publication rules. You must activate a publish rule for the publication messages you create to follow. This rule includes instructions on message chunking, if necessary.
<u>Setup Supplier to Node Page</u>	PO_CHUNK_VENDOR	Set up chunking for the batch publish rule.

Understanding the Purchase Order Dispatch EIP

The Purchase Order Dispatch EIP is an outbound asynchronous service operation to send purchase orders and purchase order change requests (change orders) to suppliers. If enabled, the system generates a Purchase Order Dispatch EIP transaction when you run the Publish Outbound Message process. This

message also supports flat-file processing. You can specify whether to send purchase orders based on business unit or supplier.

Before you can publish messages with the Purchase Order Dispatch EIP, you must:

Types of Setup	Steps
Complete application setup	On the purchase order, specify EDX as the PO dispatch method.
Complete Integration Broker setup	<ul style="list-style-type: none"> • Activate the PURCHASE_ORDER_DISPATCH service operation. • Verify the queue is in run mode. • Activate the handler. • Activate the routing. • Confirm the parameters of the routing definition. • Verify the node is active.
Complete Enterprise Component setup	<ul style="list-style-type: none"> • Activate the associated batch publish rule and specify the appropriate output for the message (an XML-based message or a flat file). If you are using message chunking, select a chunking rule ID. • If you are using message chunking, set up the chunking rule mapping definitions.

PO Header Details Page

Use the PO Header Details page (PO_HDR_DTL) to enter or change PO header information online.

Navigation:

Purchasing > Purchase Orders > Add/Update POs.

Click the **Header Details** link on the Purchase Order page.

This example illustrates the fields and controls on the PO Header Details page. You can find definitions for the fields and controls later on this page.

Maintain Purchase Order

Purchase Order

Business Unit US001
 PO ID NEXT
 Copy From []

PO Status Initial
 Budget Status Not Chkd
 Hold From Further Processing

Header

*PO Date 03/08/2013 [B] Supplier Search
 *Supplier [] Supplier Details
 *Supplier ID []
 *Buyer VP1 [] Kenneth Schumacher
 PO Reference []

Doc Tol Status Valid
 Receipt Status Not Recvd
 *Dispatch Method [] Dispatch

Amount Summary

Merchandise	0.00	
Freight/Tax/Misc.	0.00	Calculate
Total Amount	0.00	USD

Add Items From

Catalog Purchasing Kit
 Item Search

Header Details
 PO Defaults
 PO Activities
 Actions

Activity Summary
 Add Comments
 Add ShipTo Comments

Select the **Dispatch** check box to ensure that the system dispatches the PO. Also, select a dispatch **Method** of *EDX*.

Related Links

"Creating Purchase Order Lines" (PeopleSoft Purchasing)

Service Operations-General Page

Use the PeopleSoft Integration Broker to activate the Purchase Order Dispatch service operation.

Use the Service Operations-General page (IB_SERVICE) to define and activate a service operation.

Navigation:

PeopleTools, Integration Broker, Integration Setup, Service Operations, General

This example illustrates the fields and controls on the Service Operations-General page (1 of 2). You can find definitions for the fields and controls later on this page.

The screenshot shows the 'General' tab of the Service Operations-General page. Key fields include:

- Service Operation:** PURCHASE_ORDER_DISPATCH
- Operation Type:** Asynchronous - One Way
- *Operation Description:** Purchase Order Dispatch
- Operation Comments:** (Empty text area)
- Owner ID:** Purchasing
- Operation Alias:** (Empty text field)
- Service Operation Security:**
 - User/Password Required
 - *Req Verification: None
- Default Service Operation Version:**
 - *Version: VERSION_3
 - Version Description: Purchase Order Dispatch
 - Version Comments: (Empty text area)
 - Default Active
 - Routing Status:**
 - Any-to-Local: Does not exist
 - Local-to-Local: Does not exist
 - Local-to-Atom: Does not exist.
 - Runtime Schema Validation:**
 - Request Message
 - Non-Repudiation
 - Routing Actions Upon Save:**
 - Generate Any-to-Local
 - Generate Local-to-Local
- Message Information:**
 - Type: Request
 - Message.Version: PURCHASE_ORDER_DISPATCH.VERS (with search icon)
 - *Queue Name: PURCHASE_ORDER (with search icon)
 - Links: View Message, View Queue, Add New Queue

This example illustrates the fields and controls on the Service Operations-General page (2 of 2). You can find definitions for the fields and controls later on this page.

Non-Default Versions			Personalize Find [?] []	First	1-2 of 2	Last
Version	Description	Active				
VERSION_1	Purchase Order Dispatch	<input type="checkbox"/>				
VERSION_2	Purchase Order Dispatch	<input type="checkbox"/>				

For the PURCHASE_ORDER_DISPATCH service operation, select the Active check box for the applicable service operation version. If the desired version is not the default version for the service operation, the default version must also be activated.

On the General tab of the Service Operations component, select the View Queue link at the bottom of the page to access the Queue Definitions page.

Service Operation Versions

The Default Service Operation Version group box displays the most current version of this service operation. If there have been changes to the PeopleSoft application that have required the service operation to change, for example new fields or tables, then the Non-Default Versions group box displays any older versions of the service operation based on the older release of the PeopleSoft application. The

default version is always the current version, however you can use a non-default version to communicate with third-party systems that want to receive the data based on an old version. Select the link in the Non-Default Versions box to access the Service Operation Version page. This page contains information about the non-default version, including message and queue. In addition, the Logical Transforms group box contains transforms to convert the data to or from the default version. A transform program is a type of PeopleSoft Application Engine program that can convert data from one format to another. Based on your environment, you will review and possibly change these transforms.

PeopleTools: Integration Broker

Queue Definitions Page

Use the Queue Definitions page (IB_QUEUEDEFN) to activate the queue used by the service operation.

Navigation:

- PeopleTools, Integration Broker, Integration Setup, Service Operations, General. Select the Queue link attached to this service operation.
- PeopleTools, Integration Broker, Integration Setup, Queues

This example illustrates the fields and controls on the Queue Definitions page. You can find definitions for the fields and controls later on this page.

Queue Definitions

Queue Name: PURCHASE_ORDER
 Description: Purchase Order
 Comments: Purchase Order

Archive Unordered
 Queue Status: Pause
 Owner ID: Purchasing

Operations Assigned to Queue

Service Operation	Version
PO_EXPECTED_RECEIPT_BUS_UNIT	VERSION_1
PO_EXPECTED_RECEIPT_SHIPTO	VERSION_1
PURCHASE_ORDER_ACKNOWLEDGEMENT	VERSION_1
PURCHASE_ORDER_DISPATCH	VERSION_2
PURCHASE_ORDER_DISPATCH	VERSION_3
PURCHASE_ORDER_DISPATCH	VERSION_1

Define Partitioning Fields

Include	Field	Alias Name
<input type="checkbox"/>	BUSINESS_UNIT	
<input type="checkbox"/>	PO_ID	
<input type="checkbox"/>	OPERATIONNAME	
<input type="checkbox"/>	PUBLISHER	
<input type="checkbox"/>	PUBPROC	

Buttons: Save, Add Field

For the PURCHASE_ORDER queue, verify the Queue Status field has a value of *Run*.

Click the Return button to go back to the Service Operations component.

Service Operations-Handlers Page

Use the Service Operations-Handlers page (IB_SERVICEHDLR) to activate one or more service operation handlers.

Navigation:

PeopleTools, Integration Broker, Integration Setup, Service Operations, Handlers

This example illustrates the fields and controls on the Service Operations-Handlers page. You can find definitions for the fields and controls later on this page.

Service Operation: PURCHASE_ORDER_DISPATCH
 Default Version: VERSION_3
 Operation Type: Asynchronous - One Way

*Name	*Type	Sequence	*Implementation	*Status		
1 ROUTERSENDHLR	On Route		Application Class	Inactive	Details	+ -

For the PURCHASE_ORDER_DISPATCH service operation, click the Handlers tab of the Service Operations component. If you are using chunking, select the value of *Active* in the Status field for the OnRoute handler.

Service Operations-Routings Page

Use the Service Operations-Routings page (IB_SERVICERTNGS) to define and activate routing definitions on the service operation.

Navigation:

PeopleTools, Integration Broker, Integration Setup, Service Operations, Routings

This example illustrates the fields and controls on the Service Operations-Routings page. You can find definitions for the fields and controls later on this page.

Service Operation: PURCHASE_ORDER_DISPATCH
 Default Version: VERSION_3
 Routing Name:

Selected	Name	Version	Operation Type	Sender Node	Receiver Node	Direction	Status	Results
<input type="checkbox"/>	PURCHASE_ORDER_DISPATCH	VERSION_3	Asynch	PV920DVL	PSFT_XOUTBND	Outbound	Inactive	
<input type="checkbox"/>	PURCHASE_ORDER_DISPATCH_V1	VERSION_1	Asynch	PV920DVL	PSFT_XOUTBND	Outbound	Inactive	
<input type="checkbox"/>	PURCHASE_ORDER_DISPATCH_V2	VERSION_2	Asynch	PV920DVL	PSFT_XOUTBND	Outbound	Inactive	

[Return to Service](#)

For the PURCHASE_ORDER_DISPATCH service operation, click the Routings tab of the Service Operations component. Activate an outbound routing definition for each receiver node and external alias name that data will be sent to. To activate a routing, select the check box next to the routing definition and click the Activate Selected Routings button. The following routing definitions are predefined:

- The PURCHASE_ORDER_DISPATCH routing definition sends outbound purchase orders using the PeopleSoft standard XML format. This routing definition is used when you are sending data to a third-party system that is using the current version of the service operation.
- The PURCHASE_ORDER_DISPATCH_V1 routing definition sends outbound purchase orders using the PeopleSoft standard XML format and converts the data from the current service operation version (version 2) to an older version (version 1) of the service operation. This routing definition is used when you are sending data to a third-party system that is still using an older version of the service operation.

Note: You do not need to select a routing definition if the batch publish rule is set up to post to a flat file only.

Routings-Parameters Page

Use the Routings-Parameters page (IB_ROUTINGDEFNDOC) to verify the external service alias name, nodes, and transform programs used by this routing.

Navigation:

- PeopleTools, Integration Broker, Integration Setup, Service Operations, Routings. Select the link attached to the routing definition name, then select the Parameters tab.
- PeopleTools, Integration Broker, Integration Setup, Routings, Parameters

This example illustrates the fields and controls on the Routings-Parameters page. You can find definitions for the fields and controls later on this page.

The screenshot shows the 'Parameters' tab of the 'Routings-Parameters' page. The routing name is 'PURCHASE_ORDER_DISPATCH'. The service operation is 'PURCHASE_ORDER_DISPATCH' and the version is 'VERSION_3'. The sender node is 'PV920DVL' and the receiver node is 'PSFT_XOUTBND'. The type is 'Outbound Request' and the external alias is 'PURCHASE_ORDER_DISPATCH.VERSION_3'. There are four transform-related fields: 'Message.Ver into Transform 1', 'Transform Program 1', 'Transform Program 2', and 'Message.Ver out of Transforms', each with a search icon. A 'Save' button is located at the bottom left.

On the Routings tab of the Service Operations component, select the link attached to the routing definition name. This link accesses the Routing Definitions component. Select the Parameters tab and complete the following steps:

1. Confirm the external alias name in the External Alias field for the routing is correct. When sending or receiving data, the Integration Broker determines which routing to use by referring to the external alias name, not the routing name.
2. Verify or change the transform programs on this routing definition. A routing definition defines the sending and receiving nodes for a transaction and specifies any inbound and outbound transformations

to invoke. A transform program is a type of PeopleSoft Application Engine program that can convert data from one format to another; for example, from XML to a flat file. Use a transform program when one node sends a request or response message with a data structure different from the structure required by the other node. You must decide, based on your environment, to change, remove, or add transform programs.

The transform program, to convert data from the current version of a service operation to an older version, is located on the Service Operation Version page of the non-default version. Select the non-default version on the Service Operations-General page to access the Service Operation Version page.

Node Definitions Page

Use the Node Definitions page (IB_NODE) to activate node used by the service operation.

Navigation:

PeopleTools, Integration Broker, Integration Setup, Nodes, Node Definitions

This example illustrates the fields and controls on the Node Definitions page. You can find definitions for the fields and controls later on this page.

The screenshot displays the 'Node Definitions' page for a node named 'PSFT_SUPPLIER_NETWORK'. The form includes the following fields and controls:

- Node Name:** PSFT_SUPPLIER_NETWORK
- *Description:** Supplier Network
- *Node Type:** External (dropdown menu)
- *Authentication Option:** None (dropdown menu)
- *Default User ID:** VP1
- WSIL URL:** (text input)
- Hub Node:** (text input)
- Master Node:** (text input)
- Company ID:** (text input)
- IB Throttle Threshold:** (text input)
- Image Name:** (text input)
- Codeset Group Name:** (text input)
- External User ID:** (text input)
- External Password:** (text input)
- External Version:** (text input)

Checkboxes and options on the right side of the form:

- Default Local Node
- Local Node
- Active Node
- Non-Repudiation
- Segment Aware

Action buttons on the right side:

- Copy Node
- Rename Node
- Delete Node

Navigation tabs at the bottom center:

- Contact/Notes
- Properties

A 'Save' button is located at the bottom left of the form.

Verify the Active Node check box has been selected for any nodes used in the routings that you activated on the Service Operations-Routings page for PURCHASE_ORDER_DISPATCH service operation.

Nodes-Connectors Page

Use the Nodes-Connectors page (IB_NODECONN) to for an outbound service operation, verify the node is connected to the correct network.

Navigation:

PeopleTools, Integration Broker, Integration Setup, Nodes, Connectors

This example illustrates the fields and controls on the Nodes-Connectors page. You can find definitions for the fields and controls later on this page.

For an outbound service operation, verify the node or routing is connected to the correct network using the Gateway ID and Connector ID fields. Depending on the file output location, you may need a password. If a password is needed, you should use the password encryption utility on this page.

Note: Your database administrator will need to assist you with this setup.

Batch Publish Rules Page

Use the Batch Publish Rules page (EO_MSGPUBATCH) to set up publication rules.

You must activate a publish rule for the publication messages you create to follow. This rule includes instructions on message chunking, if necessary.

Navigation:

Enterprise Components > Integration Definitions > Batch Publish Rules

This example illustrates the fields and controls on the Batch Publish Rules page. You can find definitions for the fields and controls later on this page.

The screenshot shows the 'Batch Publish Rules' page with the following details:

- Service Operation:** PURCHASE_ORDER_DISPATCH
- Message.Version:** PURCHASE_ORDER_DISPATCH.VERSION_3
- Operation Description:** Purchase Order Dispatch
- Publish Rule Definition:**
 - *Publish Rule ID: PURCHASE_ORDER_DISPATCH_BU
 - *Description: PO Dispatch by Business Unit
 - *Status: Inactive
 - Chunking Rule ID: BUSINESS_UNIT
 - Alternate Chunk Table: (empty)
- Message Options:**
 - Create Message Header
 - Create Message Trailer
- Output Format:**
 - Message
 - Flat File
 - Flat File with Control Record

For the PURCHASE_ORDER_DISPATCH message name (service operation):

1. Select **Active Status** to activate this publish rule definition.
2. Select the appropriate **Output Format**. The PeopleSoft Application Engine program can create either an Extensible Markup Language (XML) message that flows through PeopleSoft Integration Broker architecture or a flat file generated on the PeopleSoft Process Scheduler server and not published elsewhere.
3. If you want to use message chunking, configure the chunking rule and then enter it in the **Chunking Rule ID** field.

Setup Supplier to Node Page

Use the Setup Supplier to Node page (PO_CHUNK_VENDOR) to set up chunking for the batch publish rule.

Navigation:

SCM Integrations > Chunking Rule > Manage ChunkRule Supplier ID Map

This example illustrates the fields and controls on the Setup Supplier to Node page. You can find definitions for the fields and controls later on this page.

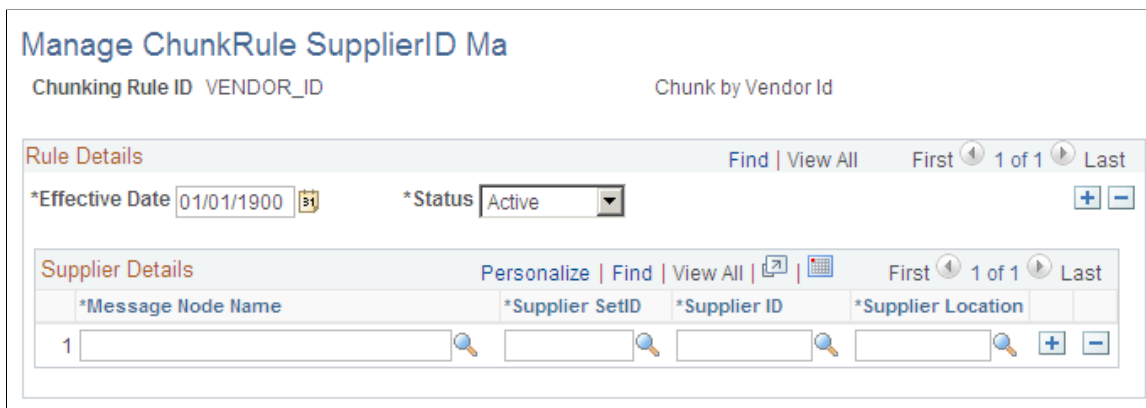

If using chunking for the batch publish rule, set up the chunking rule mapping definitions. You can use a delivered chunking rule or create a new chunking rule.

If using the VENDOR_ID chunking rule ID, access the Setup Supplier to Node page. If using the BUSINESS_UNIT chunking rule ID, access the BusUnit Mapping page.

Select the node for each supplier that receives electronic data.

Chunking is only needed if you have requirements to break up the outbound data and send them to different destinations based on attributes in the message such as business unit or supplier ID. For example, use chunking to send a single supplier's messages to a specific node setup for that trading partner. If you are using a middleware product to actually determine trading partner destinations then a single transaction with all trading partner transactions can usually be sent directly to the middleware product. You would not need to activate message chunking in this situation.

Related Links

[Setting Up Chunking](#)

Example: Processing the Purchase Order Dispatch EIP

This section discusses processing the purchase order dispatch EIP.

Pages Used to Process the Purchase Order EIP

<i>Page Name</i>	<i>Definition Name</i>	<i>Usage</i>
Dispatch Purchase Orders Page	RUN_DISP_POPO005	Run the PO Dispatch/Print process and dispatch POs, run the Email process, or run the PO Dispatch & Email multi-process job.

Page Name	Definition Name	Usage
<u>Publish Outbound Message Page</u>	IN_RUN_PUB_MSG	Initiate the outbound message publish process for outbound SCM messages that use the batch publish design pattern.
PO Dispatch Message Selection Criteria Page	PO_RUN_POD	Launch the Purchase Order Dispatch outbound transaction.

Related Links

"Creating Purchase Order Lines" (PeopleSoft Purchasing)

"Understanding Purchase Order Dispatch" (PeopleSoft Purchasing)

Dispatch Purchase Orders Page

Use the Dispatch Purchase Orders page (RUN_DISP_POPO005) to run the PO Dispatch/Print process and dispatch POs, run the Email process, or run the PO Dispatch & Email multi-process job.

Navigation:

Purchasing > Purchase Orders > Dispatch POs

This example illustrates the fields and controls on the Dispatch Purchase Orders page. You can find definitions for the fields and controls later on this page.

Ensure that the PO to be dispatched is included in your selection criteria. Click *Run* to stage POs for dispatch.

Publish Outbound Message Page

Use the Publish Outbound Message page (IN_RUN_PUB_MSG) to initiate the outbound message publish process for outbound SCM messages that use the batch publish design pattern.

Navigation:

SCM Integrations > Publish Outbound Message

This example illustrates the fields and controls on the Publish Outbound Message page. You can find definitions for the fields and controls later on this page.

Click the **Purchase Order Dispatch** check box, and click the **Purchase Order Dispatch** link to access the Purchase Order Dispatch page.

This example illustrates the fields and controls on the PO Dispatch Message Selection Criteria. You can find definitions for the fields and controls later on this page.

1. Select *BU* or *Supplier* as a **Selection Type**.

- If you select *BU*, the **BU Sel Type** fields are enabled, and you can select *All BUs* or a *1 Bus Unit*. If you select *Supplier*, the **Supplier Selection Type** fields are enabled, and you can select *1 Supplier* or *All Supplier*.

Example: Setting Up the Advanced Shipping Notice EIP

This section discusses the Advanced Shipping Notice EIP.

Pages Used to Set Up the Advanced Shipping Notice EIP

Page Name	Definition Name	Usage
<u>Business Unit Definition - Inventory Options Page</u>	BUS_UNIT_INV5	Define external interfaces.
<u>Contact Page</u>	CONTACT	Maintain information about each contact.
Contact Customer Page	CONTACT_CUST_PAGE	Indicate the primary ship to contact.
Contact Additional Info Page	CONTACT_ADDTL_INFO	Enter the preferred communication method for the selected document.
<u>Service Operations-General Page</u>	IB_SERVICE	Define and activate a service operation.
<u>Service Operations-Handlers Page</u>	IB_SERVICEHDLR	Activate one or more service operation handlers.
<u>Service Operations-Routings Page</u>	IB_SERVICERTNGS	Define and activate routing definitions on the service operation.
<u>Routings-Parameters Page</u>	IB_ROUTINGDEFNDOC	Verify the external service alias name, nodes, and transform programs used by this routing.
<u>Queue Definitions Page</u>	IB_QUEUEDEFN	Activate the queue used by the service operation.
<u>Node Definitions Page</u>	IB_NODE	Activate node used by the service operation.
<u>Nodes-Connectors Page</u>	IB_NODECONN	For an outbound service operation, verify the node is connected to the correct network.

Page Name	Definition Name	Usage
<u>Batch Publish Rules Page</u>	EO_MSGPUBATCH	Set up publication rules. You must activate a publish rule for the publication messages you create to follow. This rule includes instructions on message chunking, if necessary.
<u>Customer ID Chunk Page</u>	OM_CHUNKCUSTID	Set up chunking for the batch publish rule.

Understanding the Advanced Shipping Notice EIP

The Advanced Shipping Notice (ASN) EIP is an asynchronous outbound service operation to notify your customers that a sales order has been shipped. The data from this service operation is passed to an external system or to the PeopleSoft CRM Field Service and CRM Order Capture applications. The Advanced Shipping Notice EIP meets EDI requirements of the X.12 856–Shipping Notice/Manifest transaction set, and is also used with warehouse management systems. An ASN transaction is generated when a sales order entered from PeopleSoft Order Management has been depleted in PeopleSoft Inventory. You can specify whether to generate the ASN for all sales order shipments in the business unit, sales orders belonging to a specific shipping ID, sales orders for a specific sold to customer, or sales orders for a specific ship to customer.

Before you can publish messages with the Advanced Shipment Notice EIP, you must:

Type of Setup	Steps
Complete application setup	<ul style="list-style-type: none"> • Select the Use Advanced Shipment Notice option for the business unit on the Inventory Definition - Business Unit Options page. • Associate customers receiving Advanced Shipment Notice EIP data with an <i>ASN</i> document code and a preferred communication value of <i>XML Only</i> or <i>XML and Print</i>. If PeopleSoft Order Management is installed, you set up these values on the Contact Additional Info page in the Contact Information component.
Complete Integration Broker setup	<ul style="list-style-type: none"> • Activate the ADVANCED_SHIPPING_NOTICE service operation. • Verify the queue is in run mode. • Activate the handler. • Activate the routing. • Confirm the parameters of the routing definition. • Verify the node is active and connected to the correct network.

Type of Setup	Steps
Complete Enterprise Component setup	<ul style="list-style-type: none"> • Activate the associated batch publish rule and specify the appropriate output for the message (an XML-based message or a flat file). If you are using message chunking, select a chunking rule ID. • If you are using message chunking, set up the chunking rule mapping definitions.

Related Links

"Creating Advanced Shipping Notices" (PeopleSoft Inventory)

[Understanding POU Supplier Systems](#)

[Understanding SRS Applications](#)

Business Unit Definition - Inventory Options Page

You must enable ASN generation in the business unit shipping the items.

Use the Business Unit Definition - Inventory Options page (BUS_UNIT_INV5) to define external interfaces.

Navigation:

Set Up Financials/Supply Chain > Business Unit Related > Inventory > Inventory Definition > Inventory Options

This example illustrates the fields and controls on the Inventory Definition - Business Unit Options page. You can find definitions for the fields and controls later on this page.

Select the **Use Advanced Shipment Notice** check box in the **External Interfaces** group box.

Related Links

"Defining PeopleSoft Inventory Business Unit Attributes" (PeopleSoft Inventory)

Contact Page

You must ensure that the customer you are interacting with has a contact set up to accept EDI transmissions, and that the contact is a ship to contact.

Use the Contact page (CONTACT) to maintain information about each contact.

Navigation:

Customers >Create Customer Contacts

This example illustrates the fields and controls on the Contact page. You can find definitions for the fields and controls later on this page.

Contact Information

Maintain Contacts

SetID SHARE Contact ID 10

Find | View All First 1 of 1 Last

*Effective Date 01/01/1990 *Status Active

*Name Jeffreys, Jenny *Contact Flag External Contact

Title Manager of All

Email Address pibomuser01@ap6023fems.us.oracle.com

Salutation Code MS Ms.

*Preferred Communication Email & Print

Language Code English

Person ID

PIN

Contact Customers Contact Phone and Type

User Profile Staffing Information

Use the Contact Customer page (CONTACT_CUST_PAGE) to indicate the primary ship to contact.

Navigation:

Click the **Contact Customer Information** link on the Contact page.

This example illustrates the fields and controls on the Contact Customer page. You can find definitions for the fields and controls later on this page.

Contact Customers

Contact SetID SHARE Contact ID 10

Find | View All First 1 of 1 Last

Effective Date 01/01/1990 Name Jeffreys, Jenny

Link Contact to Customer Personalize | Find 1-24 of 24 Last

*Customer SetID	*Customer ID	Customer Name	Location	Credit Cards	Documentation	Primary Bill To	Primary Ship To	Primary Sold To	Staffing Hot List
SHARE	1000	Alliance Group	Main Office	Credit Cards	Documentation	<input checked="" type="checkbox"/>	<input checked="" type="checkbox"/>	<input checked="" type="checkbox"/>	<input type="checkbox"/>
SHARE	1001	Apex Systems	Corporate HQ	Credit Cards	Documentation	<input checked="" type="checkbox"/>	<input checked="" type="checkbox"/>	<input checked="" type="checkbox"/>	<input type="checkbox"/>
SHARE	1002	Easy Solutions	Oakland Office	Credit Cards	Documentation	<input checked="" type="checkbox"/>	<input checked="" type="checkbox"/>	<input checked="" type="checkbox"/>	<input type="checkbox"/>

Select the **Primary Ship To** check box to receive the proper shipping notifications.

Click the **Documentation** link corresponding to the appropriate customer to access the Contact Additional Info page.

This example illustrates the fields and controls on the Contact Additional Info page. You can find definitions for the fields and controls later on this page.

Contact Customers

Documentation

Contact SetID SHARE Contact ID 0037 Name Maurice Jenkins
 Customer SetID SHARE Customer ID 0000050037 Name Mercy Medical Center of Pleasanton
 Effective Date 01/01/2000

Documentation Personalize | Find | View All | [Print] [Calendar] First 1 of 1 Last

*Document Code	*Preferred Communication	Number of Copies
	Email only	1

Under the **Documentation** group box, make sure the **Document Code** is *ASN* (advanced shipping notification), and **Preferred Communication** is *XML & Print* or *XML Only*.

Related Links

"Setting Up and Maintaining Contacts" (PeopleSoft Order to Cash Common Information)

Service Operations-General Page

Use the PeopleSoft Integration Broker to activate the Advanced Shipping Notice service operation.

Use the Service Operations-General page (IB_SERVICE) to define and activate a service operation.

Navigation:

PeopleTools, Integration Broker, Integration Setup, Service Operations, General

This example illustrates the fields and controls on the Service Operations-General page (1 of 2). You can find definitions for the fields and controls later on this page.

The screenshot shows the 'General' tab of the Service Operations-General page. The main form contains the following fields and controls:

- Service Operation:** ADVANCED_SHIPPING_NOTICE
- Operation Type:** Asynchronous - One Way
- *Operation Description:** Advanced Shipping Notice
- Operation Comments:** (Text area)
- Owner ID:** Inventory
- Operation Alias:** (Text field)
- Service Operation Security:**
 - User/Password Required
 - *Req Verification: None
- Default Service Operation Version:**
 - *Version: VERSION_2
 - Version Description: Advanced Shipping Notice
 - Version Comments: (Text area)
 - Default Active
 - Routing Status:**
 - Any-to-Local: Does not exist
 - Local-to-Local: Does not exist
 - Local-to-Atom: Does not exist.
 - Runtime Schema Validation:**
 - Request Message
 - Non-Repudiation
 - Routing Actions Upon Save:**
 - Generate Any-to-Local
 - Generate Local-to-Local
- Message Information:**
 - Type: Request
 - Message.Version: ADVANCED_SHIPPING_NOTICE.VERS (with View Message link)
 - *Queue Name: ADVANCED_SHIPPING_NOTICE (with View Queue and Add New Queue links)

This example illustrates the fields and controls on the Service Operations-General page (2 of 2). You can find definitions for the fields and controls later on this page.

Non-Default Versions		
Version	Description	Active
VERSION_1	Advanced Shipping Notice	<input type="checkbox"/>

For the ADVANCED_SHIPPING_NOTICE service operation, select the Active check box for the applicable service operation version. If the desired version is not the default version for the service operation, the default version must also be activated.

On the General tab of the Service Operations component, select the View Queue link at the bottom of the page to access the Queue Definitions page.

Service Operation Versions

The Default Service Operation Version group box displays the most current version of this service operation. If there have been changes to the PeopleSoft application that have required the service operation to change, for example new fields or tables, then the Non-Default Versions group box displays any older versions of the service operation based on the older release of the PeopleSoft application. The default version is always the current version, however you can use a non-default version to communicate

with third-party systems that want to receive the data based on an old version. Select the link in the Non-Default Versions box to access the Service Operation Version page. This page contains information about the non-default version, including message and queue. In addition, the Logical Transforms group box contains transforms to convert the data to or from the default version. A transform program is a type of PeopleSoft Application Engine program that can convert data from one format to another. Based on your environment, you will review and possibly change these transforms.

PeopleTools: Integration Broker

Queue Definitions Page

Use the Queue Definitions page (IB_QUEUEDEFN) to activate the queue used by the service operation.

Navigation:

- PeopleTools, Integration Broker, Integration Setup, Service Operations, General. Select the Queue link attached to this service operation.
- PeopleTools, Integration Broker, Integration Setup, Queues

This example illustrates the fields and controls on the Queue Definitions page. You can find definitions for the fields and controls later on this page.

Queue Definitions

Queue Name:

Description:

Comments:

Archive Unordered

Queue Status:

Owner ID:

Operations Assigned to Queue

Service Operations	Version
ADVANCED_SHIPPING_NOTICE	VERSION_1
ADVANCED_SHIPPING_NOTICE	VERSION_2
ADVANCED_SHIPPING_RECEIPT	VERSION_2
ADVANCED_SHIPPING_RECEIPT	VERSION_1

Define Partitioning Fields

Include	Field	Alias Name
<input type="checkbox"/>	CUST_ID	<input type="text"/>
<input type="checkbox"/>	CARRIER_ID	<input type="text"/>
<input type="checkbox"/>	SHIP_TYPE_ID	<input type="text"/>
<input type="checkbox"/>	PROCESS_INSTANCE	<input type="text"/>
<input type="checkbox"/>	OPERATIONNAME	<input type="text"/>
<input type="checkbox"/>	PUBLISHER	<input type="text"/>
<input type="checkbox"/>	PUBPROC	<input type="text"/>

For the ADVANCED_SHIPPING_NOTICE queue, verify the Queue Status field has a value of *Run*.

Click the Return button to go back to the Service Operations component.

Service Operations-Handlers Page

Use the Service Operations-Handlers page (IB_SERVICEHDLR) to activate one or more service operation handlers.

Navigation:

PeopleTools, Integration Broker, Integration Setup, Service Operations, Handlers

This example illustrates the fields and controls on the Service Operations-Handlers page. You can find definitions for the fields and controls later on this page.

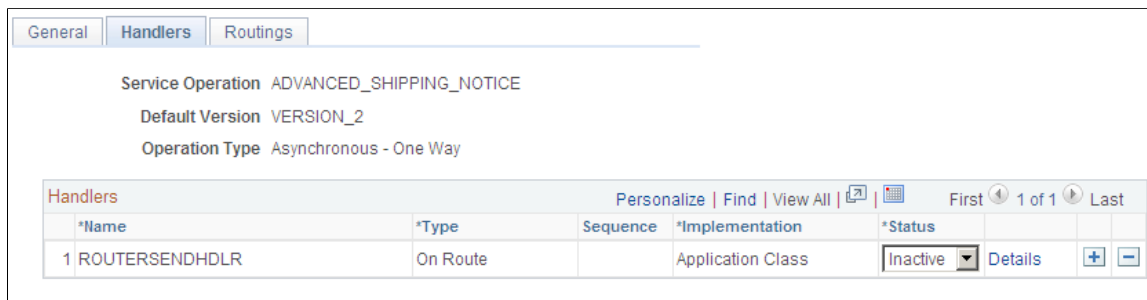

For the ADVANCED_SHIPPING_NOTICE service operation, click the Handlers tab of the Service Operations component. If you are using chunking, select the value of *Active* in the Status field for the OnRoute handler.

Service Operations-Routings Page

Use the Service Operations-Routings page (IB_SERVICERTNGS) to define and activate routing definitions on the service operation.

Navigation:

PeopleTools, Integration Broker, Integration Setup, Service Operations, Routings

This example illustrates the fields and controls on the Service Operations-Routings page. You can find definitions for the fields and controls later on this page.

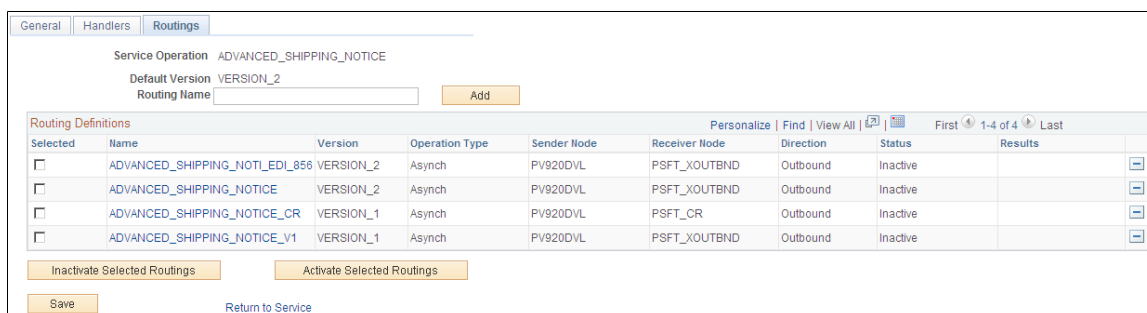

For the ADVANCED_SHIPPING_NOTICE service operation, click the Routings tab of the Service Operations component. Activate an outbound routing definition for each receiver node and external alias name that data will be sent to. To activate a routing, select the check box next to the routing definition and click the Activate Selected Routings button. The following routing definitions are predefined:

- The ADVANCED_SHIPPING_NOTI_EDI_856 routing definition sends outbound shipping notices using the EDI X.12 856 format as a flat file. The data is converted from the PeopleSoft standard XML format to the EDI X.12 856 transaction format and then from XML to a flat file. If you wish to send the data as an XML file using the EDI X.12 856 format, then alter the routing definition to remove the second transform program.

- The `ADVANCED_SHIPPING_NOTICE` routing definition sends outbound shipping notices using the PeopleSoft standard XML format. This routing definition is used when you are sending data to a third-party system that is using the current version of the service operation.
- The `ADVANCED_SHIPPING_NOTICE_CR` routing definition sends outbound shipping notices using the PeopleSoft standard XML format to PeopleSoft CRM.
- The `ADVANCED_SHIPPING_NOTICE_V1` routing definition sends outbound shipping notices using the PeopleSoft standard XML format and converts the data from the current service operation version (version 2) to an older version (version 1) of the service operation. This routing definition is used when you are sending data to a third-party system that is still using an older version of the service operation.

Note: You do not need to select a routing definition if the batch publish rule is set up to post to a flat file only.

Routings-Parameters Page

Use the Routings-Parameters page (`IB_ROUTINGDEFNDOC`) to verify the external service alias name, nodes, and transform programs used by this routing.

Navigation:

- PeopleTools, Integration Broker, Integration Setup, Service Operations, Routings. Select the link attached to the routing definition name, then select the Parameters tab.
- PeopleTools, Integration Broker, Integration Setup, Routings, Parameters

This example illustrates the fields and controls on the Routings-Parameters page. You can find definitions for the fields and controls later on this page.

IB Routing Definitions

Routing Definitions
Parameters
Connector Properties
Routing Properties

Routing Name ADVANCED_SHIPPING_NOTI_ED1_856

Service Operation ADVANCED_SHIPPING_NOTICE

Service Operation Version VERSION_2

Sender Node PV920DVL

Receiver Node PSFT_XOUTBND

Parameters

Type Outbound Request

External Alias

WS Security
Alias References

Message.Ver into Transform 1

Transform Program 1

Transform Program 2

Message.Ver out of Transforms

[Routing Definitions](#) | [Parameters](#) | [Connector Properties](#) | [Routing Properties](#)

On the Routings tab of the Service Operations component, select the link attached to the routing definition name. This link accesses the Routing Definitions component. Select the Parameters tab and complete the following steps:

1. Confirm the external alias name in the External Alias field for the routing is correct. When sending or receiving data, the Integration Broker determines which routing to use by referring to the external alias name, not the routing name.
2. Verify or change the transform programs on this routing definition. A routing definition defines the sending and receiving nodes for a transaction and specifies any inbound and outbound transformations to invoke. A transform program is a type of PeopleSoft Application Engine program that can convert data from one format to another; for example, from XML to a flat file. Use a transform program when one node sends a request or response message with a data structure different from the structure required by the other node. You must decide, based on your environment, to change, remove, or add transform programs. The ADVANCED_SHIPPING_NOTI_ED1_856 routing definition is delivered with two transform programs. The EDI_856_O transform program converts outbound shipping notices from the standard PeopleSoft XML format to the EDI X.12 856 transaction format (still in XML). The XML_TO_FILE transform program converts the EDI X.12 856 formatted data from XML to a flat file format. You can remove the XML_TO_FILE transform program to send your data in the XML EDI X.12 856 format. If you are not using EDI then you will want to use the ADVANCED_SHIPPING_NOTICE routing definition instead.

The transform program, to convert data from the current version of a service operation to an older version, is located on the Service Operation Version page of the non-default version. Select the non-default version on the Service Operations-General page to access the Service Operation Version page.

Node Definitions Page

Use the Node Definitions page (IB_NODE) to activate node used by the service operation.

Navigation:

PeopleTools, Integration Broker, Integration Setup, Nodes, Node Definitions

This example illustrates the fields and controls on the Node Definitions page. You can find definitions for the fields and controls later on this page.

The screenshot displays the 'Node Definitions' page with the following details:

- Node Name:** PSFT_SUPPLIER_NETWORK
- *Description:** Supplier Network
- *Node Type:** External (dropdown menu)
- *Authentication Option:** None (dropdown menu)
- *Default User ID:** VP1
- WSIL URL:** (empty text field)
- Hub Node:** (empty text field)
- Master Node:** (empty text field)
- Company ID:** (empty text field)
- IB Throttle Threshold:** (empty text field)
- Image Name:** (empty text field)
- Codeset Group Name:** (empty text field)
- External User ID:** (empty text field)
- External Password:** (empty text field)
- External Version:** (empty text field)

Checkboxes and their states:

- Default Local Node
- Local Node
- Active Node
- Non-Repudiation
- Segment Aware

Action buttons: Copy Node, Rename Node, Delete Node, Save.

Navigation: Contact/Notes, Properties.

Verify the Active Node check box has been selected for any nodes used in the routings that you activated on the Service Operations-Routings page for ADVANCED_SHIPPING_NOTICE service operation.

Nodes-Connectors Page

Use the Nodes-Connectors page (IB_NODECONN) to for an outbound service operation, verify the node is connected to the correct network.

Navigation:

PeopleTools, Integration Broker, Integration Setup, Nodes, Connectors

This example illustrates the fields and controls on the Nodes-Connectors page. You can find definitions for the fields and controls later on this page.

The screenshot shows the 'Nodes-Connectors' page with the 'Connectors' tab selected. The 'Node Name' field contains 'PSFT_ORACLE_SUPPLIER_NETWORK' and there is a 'Ping Node' button. Below this is a 'Details' section with three fields: 'Gateway ID' (LOCAL), 'Connector ID' (empty), and '*Delivery Mode' (Guaranteed Delivery). A 'Save' button is located at the bottom left of the form.

For an outbound service operation, verify the node or routing is connected to the correct network using the Gateway ID and Connector ID fields. Depending on the file output location, you may need a password. If a password is needed, you should use the password encryption utility on this page.

Note: Your database administrator will need to assist you with this setup.

Batch Publish Rules Page

Use the Batch Publish Rules page (EO_MSGPUBATCH) to set up publication rules.

You must activate a publish rule for the publication messages you create to follow. This rule includes instructions on message chunking, if necessary.

Navigation:

Enterprise Components > Integration Definitions > Batch Publish Rules

This example illustrates the fields and controls on the Batch Publish Rules page. You can find definitions for the fields and controls later on this page.

The screenshot shows the 'Batch Publish Rules' page with the following details:

- Service Operation:** ADVANCED_SHIPPING_NOTICE
- Message.Version:** ADVANCED_SHIPPING_NOTICE.VERSION_2
- Operation Description:** Advanced Shipping Notice
- Publish Rule Definition:**
 - *Publish Rule ID: ADVANCED_SHIPPING_NOTICE
 - *Description: Advanced Shipping Notice
 - *Status: Inactive
 - Chunking Rule ID: (empty)
 - Alternate Chunk Table: (empty)
- Message Options:**
 - Create Message Header
 - Create Message Trailer
- Output Format:**
 - Message
 - Flat File
 - Flat File with Control Record

For the ADVANCED_SHIPPING_NOTICE message name (service operation):

1. Select **Active Status** to activate this publish rule definition.
2. Select the appropriate **Output Format**. The PeopleSoft Application Engine program can create either an Extensible Markup Language (XML) message that flows through PeopleSoft Integration Broker architecture or a flat file generated on the PeopleSoft Process Scheduler server and not published elsewhere. If you are sending data to a PeopleSoft system, select **Message** as your format.
3. If you want to use message chunking, configure a chunking rule and then enter it in the **Chunking Rule ID** field.

Customer ID Chunk Page

Use the Customer ID Chunk page (OM_CHUNKCUSTID) to set up chunking for the batch publish rule.

Navigation:

SCM Integrations > Chunking Rule > CustID to Node Mapping

This example illustrates the fields and controls on the Customer ID Chunk page. You can find definitions for the fields and controls later on this page.

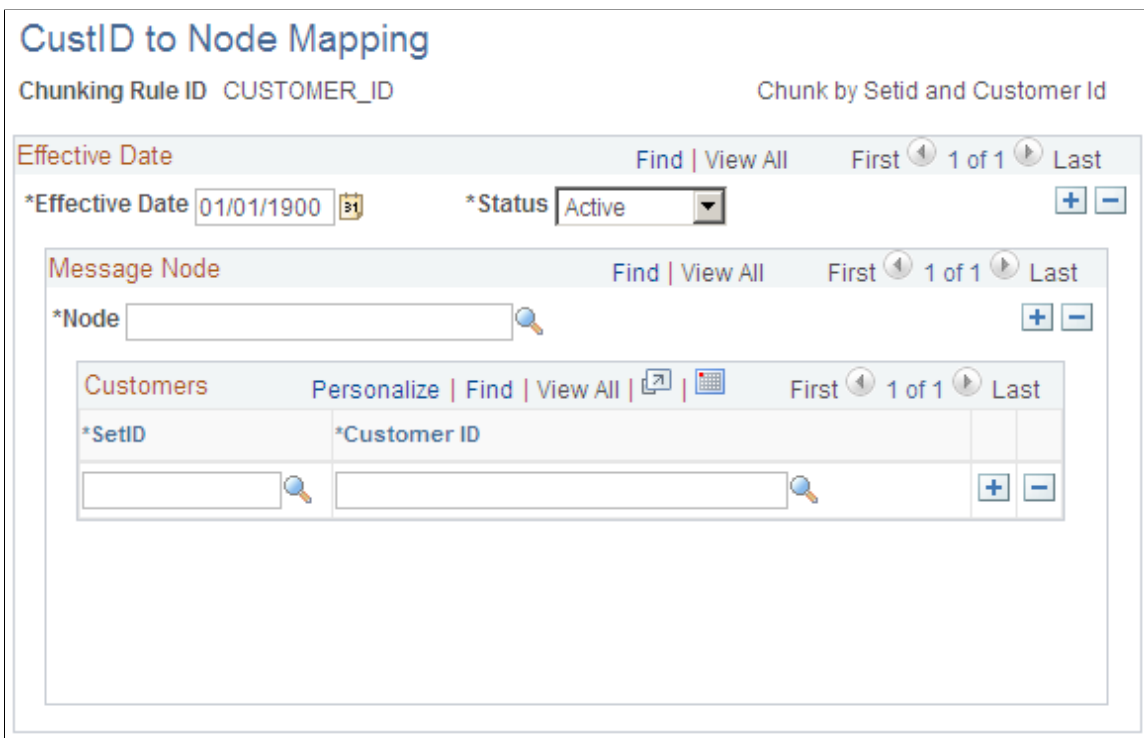

If using chunking for the batch publish rule, set up the chunking rule mapping definitions. You can use a delivered chunking rule or create a new chunking rule.

If using the CUSTOMER_ID chunking rule ID, access the Customer ID Chunk page.

Select the node for each customer that receives electronic data.

Chunking is only needed if you have requirements to break up the outbound data and send them to different destinations based on attributes in the message such as business unit or customer ID. The most common use of chunking with the ASN message is to send a single customer's messages to a specific node setup for that trading partner. If you are using a middleware product to actually determine trading partner destinations then a single transaction with all trading partner transactions can usually be sent directly to the middleware product. You would not need to activate message chunking in this situation.

Related Links

[Setting Up Chunking](#)

Example: Processing the Advanced Shipping Notice EIP

This sections discusses processing the Advanced Shipping Notice EIP.

Pages Used to Process the Advanced Shipping Notice EIP

Page Name	Definition Name	Usage
Publish Outbound Message Page	IN_RUN_PUB_MSG	Initiate the outbound message publish process for outbound SCM messages that use the batch publish design pattern.
Advanced Shipping Notices Selection Criteria Page	IN_RUN_SHPNTC_ASN	Launch the Advanced Shipping Notices outbound transaction for sales orders that have been depleted.

Publish Outbound Message Page

Use the Publish Outbound Message page (IN_RUN_PUB_MSG) to initiate the outbound message publish process for outbound SCM messages that use the batch publish design pattern.

Navigation:

SCM Integrations > Publish Outbound Message

This example illustrates the fields and controls on the Publish Outbound Message page. You can find definitions for the fields and controls later on this page.

The screenshot shows the 'Publish Outbound Message' page. At the top, there are tabs for 'Run Control ID', 'Publish', 'Report Manager', and 'Process Monitor', along with a 'Run' button. Below these is a 'Language' dropdown menu currently set to 'English'. The page is organized into several panels, each representing a different category of messages:

- Inventory Messages:** Includes checkboxes for 'Balance Notification', 'Advanced Shipping Notices' (checked), 'Interunit Expected Receipts', 'Internal Location Exp Receipts', 'Item Status Change', 'TMS Order Release', 'GTIN Data Notification', and 'VMI Interunit Expected Receipt'.
- Purchasing Messages:** Includes checkboxes for 'Request for Quotation', 'Purchase Order Dispatch', 'Return To Vendor (Supplier)', and 'PO Expected Receipts'.
- Order Management Messages:** Includes checkboxes for 'Sales Order Acknowledgement', 'Sales Order Change Notice', 'Sales Quote Notice', 'Product Price List', and 'Sales Order/Quote Status'.
- Manufacturing Messages:** Includes checkboxes for 'Production Order Update', 'Item Revision', and 'Replenish Request Dispatch'.
- Billing Messages:** Includes a checkbox for 'Billing Invoice Notice'.
- Supplier Contract Management:** Includes a checkbox for 'Supplier Contract Syndication'.

Click the **Advanced Shipping Notices** check box, and click the **Advanced Shipping Notices** link to access the Advanced Shipping Notices Selection Criteria page.

This example illustrates the fields and controls on the Advanced Shipping Notices Selection Criteria page. You can find definitions for the fields and controls later on this page.

Advanced Shipping Notices Selection Criteria

Run Control ID publish Report Manager Process Monitor Run

Language English

Selection Criteria Find | View All First 1 of 1 Last

*Unit + -

*Request ID Description

Selection Options

All Shipments

Sold To Customer

Ship To Customer

Shipping ID

Delivery ID

Re-Generate Message

Selection Parameters

Source Bus Unit

Sold To Customer

Ship To Customer

Shipping ID

Delivery ID

OK Cancel

Field or Control	Description
All Shipments	Select to generate this transaction for all sales order shipments that have been through the Depletion process (INPDDEPL), but have not previously generated an ASN.
Sold To Customer	Select to generate this transaction for a sales order with a specific sold to customer.
Ship To Customer	Select to generate this transaction for a sales order with a specific ship to customer.
Specific Shipping ID	Select to generate this transaction for sales orders with a specific shipping ID.
Source Bus Unit	Select a valid source business unit. A source business unit is the PeopleSoft Order Management business unit that created the sales order. This field is required if you elect in the Selection Options group box to generate this transaction for a specific sold to or ship to customer. This field is not available for entry if you elect in the Selection Options group box to generate this transaction for all shipments, or for a specific shipping ID.

<i>Field or Control</i>	<i>Description</i>
Sold To Customer	Select a valid sold to customer. This field is only available for entry and is required if you elect in the Selection Options group box to generate this transaction for a specific sold to customer.
Ship To Customer	Select a valid ship to customer. This field is only available for entry and is required if you elect in the Selection Options group box to generate this transaction for a specific ship to customer.
Shipping ID	Select a valid shipping ID. This field is only available for entry and is required if you elect in the Selection Options group box to generate this transaction for a specific shipping ID.
Re-Generate Message	Select this option to regenerate a message for data that have already been sent out.

Note: When you navigate to the process monitor and wait till the process completes successfully, you can click the **Details** link and then the **View Log/Trace** link. This shows the output file as a link. The system generates the flat file to reflect the ASN information for the corresponding shipping ID.

Data Separation

PeopleSoft Inventory creates a single occurrence of an ASN transaction for each combination of business unit, source business unit, sold to customer, ship to customer, shipping ID, carrier ID, and ship via. The transaction also lists the ASN creation date and time, the source business unit's address, the vehicle ID, the quantity ordered, the shipping weight, and, if defined, the shipping container ID and container type.

PeopleSoft sends the generated transaction to the ship to customer, the sold to customer, or both.

Example: Setting Up the Billing Invoice EIP

This section discusses the Billing Invoice EIP.

Pages Used to Process Billing Invoices

<i>Page Name</i>	<i>Definition Name</i>	<i>Usage</i>
<u>Contact Page</u>	CONTACT	Maintain information about each contact.

Page Name	Definition Name	Usage
Contact Customer Page	CONTACT_CUST_PAGE	Build the relationship between the contact and the different customer IDs the contact serves or is associated with. If the contact is only associated with one customer, enter that customer on this page. If the contact is a broker, for example, use this page to establish the relationships with the multiple customers that the broker serves. Set up security options on the Self Service Security tab.
Contact Additional Info Page	CONTACT_ADDTL_INFO	Enter the preferred communication method for the selected document.
<u>Service Operations-General Page</u>	IB_SERVICE	Define and activate a service operation.
<u>Service Operations-Handlers Page</u>	IB_SERVICEHDLR	Activate one or more service operation handlers.
<u>Service Operations-Routings Page</u>	IB_SERVICERTNGS	Define and activate routing definitions on the service operation.
<u>Routings-Parameters Page</u>	IB_ROUTINGDEFNDOC	Verify the external service alias name, nodes, and transform programs used by this routing.
<u>Queue Definitions Page</u>	IB_QUEUEDEFN	Activate the queue used by the service operation.
<u>Node Definitions Page</u>	IB_NODE	Activate node used by the service operation.
<u>Nodes-Connectors Page</u>	IB_NODECONN	For an outbound service operation, verify the node is connected to the correct network.
<u>Batch Publish Rules Page</u>	EO_MSGPUBATCH	Activate the batch publish rule for the publication messages you create. This rule includes instructions on message chunking, if necessary.
<u>Customer ID Chunk Page</u>	OM_CHUNKCUSTID	Set up chunking for the batch publish rule.

Understanding the Billing Invoice EIP

The Billing Invoice Notice EIP is an asynchronous outbound service operation to send invoices to your customers. The data from this service operation is passed to an external system. The Billing Invoice Notice EIP meets EDI requirements of the X.12 810 transaction set. The transaction is generated when you run the Finalize Bills process (BIIVC000); this populates the BI_HDR_EC table with the outbound invoice data. Once the data is in BI_HDR_EC, the outbound publish process can create the outbound message or flat file.

Before you can send invoices with the Billing Invoice EIP, you must:

Types of Setup	Steps
Complete application setup	Associate customers receiving Billing Invoice Notice EIP messages with a preferred communication value of <i>XML Only</i> or <i>XML and Print</i> , and a document code of <i>Invoice</i> . The system provides these values as a default to the Standard Billing - Address Info page when you create a bill for this customer.
Complete Integration Broker setup	<ul style="list-style-type: none"> • Activate the BILLING_INVOICE_NOTICE service operation. • Verify the queue is in run mode. • Activate the handler. • Activate the routing. • Confirm the parameters of the routing definition. • Verify the node is active and connected to the correct network.
Complete Enterprise Component setup	<ul style="list-style-type: none"> • Activate the associated batch publish rule and specify the appropriate output for the message (an XML-based message or a flat file). If you are using message chunking, select a chunking rule ID. • If you are using message chunking, set up the chunking rule mapping definitions.

Related Links

"Setting Up and Maintaining Contacts" (PeopleSoft Order to Cash Common Information)

Contact Page

You must ensure that the customer you are interacting with has a contact set up to accept EDI transmissions, and that the contact is a ship to contact.

Use the Contact page (CONTACT) to maintain information about each contact.

Navigation:

Customers >Create Customer Contacts

This example illustrates the fields and controls on the Contact page. You can find definitions for the fields and controls later on this page.

The screenshot shows the 'Maintain Contacts' page. At the top, it displays 'SetID SHARE' and 'Contact ID 10'. Below this is a 'Contact Information' section with various fields:

- *Effective Date: 01/01/1990
- *Name: Jeffreys, Jenny
- Title: Manager of All
- Email Address: pibomuser01@ap6023fems.us.oracle.com
- Salutation Code: MS (with a dropdown showing 'Ms.')
- *Preferred Communication: Email & Print
- Language Code: English
- Person ID and PIN fields are also present.

 Navigation links at the bottom include 'Contact Customers', 'Contact Phone and Type', 'User Profile', and 'Staffing Information'.

Use the Contact Customer page (CONTACT_CUST_PAGE) to build the relationship between the contact and the different customer IDs the contact serves or is associated with.

If the contact is only associated with one customer, enter that customer on this page. If the contact is a broker, for example, use this page to establish the relationships with the multiple customers that the broker serves. Set up security options on the Self Service Security tab.

Navigation:

Click the **Contact Customer Information** link on the Contact page.

This example illustrates the fields and controls on the Contact Customer page. You can find definitions for the fields and controls later on this page.

The screenshot shows the 'Contact Customers' page. It features a 'Link Contact to Customer' table. The table has the following columns:

- *Customer SetID
- *Customer ID
- Customer Name
- Location
- Credit Cards
- Documentation
- Primary Bill To
- Primary Ship To
- Primary Sold To
- Staffing Hot List

 A single row is displayed with the following data:

- *Customer SetID: SHARE
- *Customer ID: 0000050037
- Customer Name: Mercy Medical Center of Pleasanton
- Location: Main
- Credit Cards: [checked]
- Documentation: [checked]
- Primary Bill To: [checked]
- Primary Ship To: [checked]
- Primary Sold To: [checked]
- Staffing Hot List: [unchecked]

 Navigation links at the bottom include 'Contact Information', 'Contact Phone and Type', and 'User Profile'.

Click the **Primary Bill To** check box to receive the proper invoice notifications.

Click the **Documentation** link corresponding to the appropriate customer to access the Documentation page.

This example illustrates the fields and controls on the Documentation page. You can find definitions for the fields and controls later on this page.





Contact Customers

Documentation

 Contact SetID SHARE
 Contact ID 10
 Name Jeffreys,Jenny

 Customer SetID SHARE
 Customer ID 1000
 Name Alliance Group

 Effective Date 01/01/1990

Documentation
Personalize | Find | View All |  | 
First  1 of 1  Last

*Document Code	*Preferred Communication	Number of Copies	
<input type="text"/>	<input type="text" value="Email & Print"/>	<input type="text" value="1"/>	<input type="button" value="+"/> <input type="button" value="-"/>

Under the **Documentation** group box, make sure the **Document Code** is *INVC* (invoice), and **Preferred Communication** is *XML & Print* or *XML only*.

Related Links

"Setting Up and Maintaining Contacts" (PeopleSoft Order to Cash Common Information)

Service Operations-General Page

Use the PeopleSoft Integration Broker to activate the Billing Invoice Notice service operation.

Use the Service Operations-General page (IB_SERVICE) to define and activate a service operation.

Navigation:

PeopleTools, Integration Broker, Integration Setup, Service Operations, General

This example illustrates the fields and controls on the Service Operations-General page (1 of 2). You can find definitions for the fields and controls later on this page.

The screenshot shows the 'General' tab of the Service Operations-General page. The main section contains the following fields and controls:

- Service Operation:** BILLING_INVOICE_NOTICE
- Operation Type:** Asynchronous - One Way
- *Operation Description:** Billing Invoice Notice
- Operation Comments:** (Empty text area)
- Owner ID:** Billing
- Operation Alias:** (Empty text area)
- Service Operation Security:**
 - User/Password Required
 - *Req Verification:** None

The **Default Service Operation Version** section includes:

- *Version:** VERSION_4
- Version Description:** Billing Invoice Notice
- Version Comments:** (Empty text area)
- Runtime Schema Validation:**
 - Request Message
 - Non-Repudiation
- Routing Status:**
 - Any-to-Local: Does not exist
 - Local-to-Local: Does not exist
 - Local-to-Atom: Does not exist.
- Routing Actions Upon Save:**
 - Generate Any-to-Local
 - Generate Local-to-Local

The **Message Information** section shows:

- Type:** Request
- Message.Version:** BILLING_INVOICE_NOTICE.VERSION_4 (with a 'View Message' link)
- *Queue Name:** BILLING_INVOICE (with 'View Queue' and 'Add New Queue' links)

This example illustrates the fields and controls on the Service Operations-General page (2 of 2). You can find definitions for the fields and controls later on this page.

Non-Default Versions		
Version	Description	Active
VERSION_3	Billing Invoice Notice	<input type="checkbox"/>

For the BILLING_INVOICE_NOTICE service operation, select the Active check box for the applicable service operation version. If the desired version is not the default version for the service operation, the default version must also be activated.

On the General tab of the Service Operations component, select the View Queue link at the bottom of the page to access the Queue Definitions page.

Service Operation Versions

The Default Service Operation Version group box displays the most current version of this service operation. If there have been changes to the PeopleSoft application that have required the service operation to change, for example new fields or tables, then the Non-Default Versions group box displays any older versions of the service operation based on the older release of the PeopleSoft application. The default version is always the current version, however you can use a non-default version to communicate

with third-party systems that want to receive the data based on an old version. Select the link in the Non-Default Versions box to access the Service Operation Version page. This page contains information about the non-default version, including message and queue. In addition, the Logical Transforms group box contains transforms to convert the data to or from the default version. A transform program is a type of PeopleSoft Application Engine program that can convert data from one format to another. Based on your environment, you will review and possibly change these transforms.

PeopleTools: Integration Broker

Queue Definitions Page

Use the Queue Definitions page (IB_QUEUEDEFN) to activate the queue used by the service operation.

Navigation:

- PeopleTools, Integration Broker, Integration Setup, Service Operations, General. Select the View Queue link attached to this service operation.
- PeopleTools, Integration Broker, Integration Setup, Queues

This example illustrates the fields and controls on the Queue Definitions page. You can find definitions for the fields and controls later on this page.

Queue Definitions

Queue Name: BILLING_INVOICE

Description:

Comments:

Archive Unordered

Queue Status:

Owner ID:

Operations Assigned to Queue

Service Operations	Version
BILLING_INVOICE_NOTICE	VERSION_4
BILLING_INVOICE_NOTICE	VERSION_3

Define Partitioning Fields

Include	Field	Alias Name
<input type="checkbox"/>	SETID	<input type="text"/>
<input type="checkbox"/>	CUST_ID	<input type="text"/>
<input type="checkbox"/>	BUSINESS_UNIT	<input type="text"/>
<input type="checkbox"/>	INVOICE	<input type="text"/>
<input type="checkbox"/>	DOC_SEQ_NBR	<input type="text"/>
<input type="checkbox"/>	FROM_DT	<input type="text"/>
<input type="checkbox"/>	TO_DT	<input type="text"/>
<input type="checkbox"/>	BILL_TO_CUST_ID	<input type="text"/>
<input type="checkbox"/>	ADDRESS_SEQ_NUM	<input type="text"/>
<input type="checkbox"/>	BILL_INQUIRY_PHONE	<input type="text"/>

For the BILLING_INVOICE queue, verify the Queue Status field has a value of *Run*.

Click the Return button to go back to the Service Operations component.

Service Operations-Handlers Page

Use the Service Operations-Handlers page (IB_SERVICEHDLR) to activate one or more service operation handlers.

Navigation:

PeopleTools, Integration Broker, Integration Setup, Service Operations, Handlers

This example illustrates the fields and controls on the Service Operations-Handlers page. You can find definitions for the fields and controls later on this page.

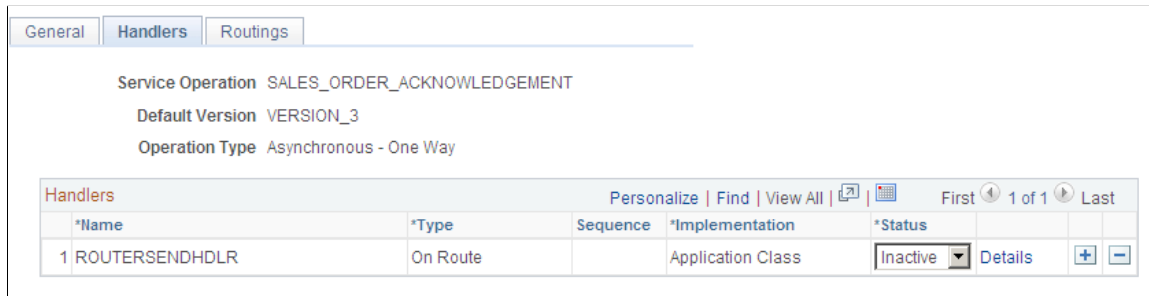

For the BILLING_INVOICE_NOTICE service operation, click the Handlers tab of the Service Operations component. If you want to use chunking, select the value of *Active* in the Status field for the OnRoute handler.

Service Operations-Routings Page

Use the Service Operations-Routings page (IB_SERVICERTNGS) to define and activate routing definitions on the service operation.

Navigation:

PeopleTools, Integration Broker, Integration Setup, Service Operations, Routings

This example illustrates the fields and controls on the Service Operations-Routings page. You can find definitions for the fields and controls later on this page.

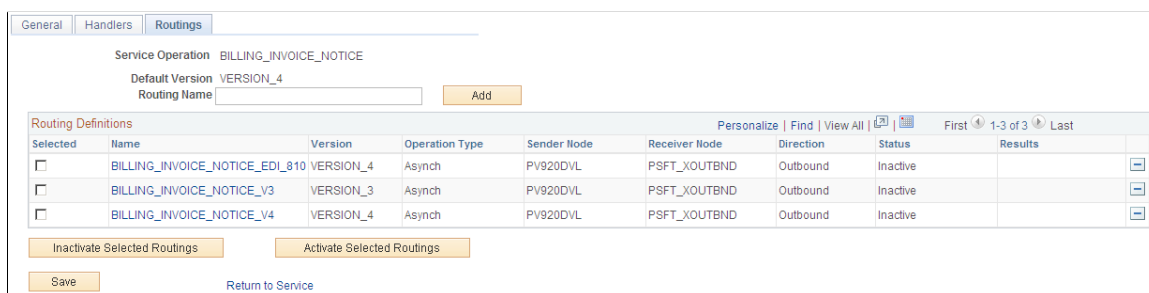

For the BILLING_INVOICE_NOTICE service operation, click the Routings tab of the Service Operations component. Activate an outbound routing definition for each receiver node and external alias name that data will be sent to. To activate a routing, select the check box next to the routing definition and click the Activate Selected Routings button. The following routing definitions are predefined:

- The BILLING_INVOICE_NOTICE_ED1_810 routing definition sends outbound invoices using the EDI X.12 810 format as a flat file. The data is converted from the PeopleSoft standard XML format to the EDI X.12 810 transaction format (still in XML) and then from XML to a flat file. If you wish to send the data as an XML file using the EDI X.12 810 format, then alter the routing definition to remove the second transform program.
- The BILLING_INVOICE_NOTICE_V3 routing definition sends outbound invoices using the PeopleSoft standard XML format and converts the data from the current service operation version (version 4) to an older version (version 3) of the service operation. This routing definition is used when you are sending data to a third-party system that is still using an older version of the service operation.
- The BILLING_INVOICE_NOTICE_V4 routing definition sends outbound invoices using the PeopleSoft standard XML format. This routing definition is used when you are sending data to a third-party system that is using the current version of the service operation.

Note: You do not need to select a routing definition if the batch publish rule is set up to post to a flat file only.

Routings-Parameters Page

Use the Routings-Parameters page (IB_ROUTINGDEFNDOC) to verify the external service alias name, nodes, and transform programs used by this routing.

Navigation:

- PeopleTools, Integration Broker, Integration Setup, Service Operations, Routings. Select the link attached to the routing definition name, then select the Parameters tab.
- PeopleTools, Integration Broker, Integration Setup, Routings, Parameters

This example illustrates the fields and controls on the Routings-Parameters page. You can find definitions for the fields and controls later on this page.

IB Routing Definitions

Routing Definitions
Parameters
Connector Properties
Routing Properties

Routing Name BILLING_INVOICE_NOTICE_EDI_810

Service Operation BILLING_INVOICE_NOTICE

Service Operation Version VERSION_4

Sender Node PV920DVL

Receiver Node PSFT_XOUTBND

Parameters

Type Outbound Request

External Alias

WS Security
Alias References

Message.Ver into Transform 1

Transform Program 1

Transform Program 2

Message.Ver out of Transforms

Save
Return

Routing Definitions | Parameters | Connector Properties | Routing Properties

On the Routings tab of the Service Operations component, select the link attached to the routing definition name. This link accesses the Routing Definitions component. Select the Parameters tab and complete the following steps:

1. Confirm the external alias name in the External Alias field for the routing is correct. When sending or receiving data, the Integration Broker determines which routing to use by referring to the external alias name, not the routing name.
2. Verify or change the transform programs on this routing definition. A routing definition defines the sending and receiving nodes for a transaction and specifies any inbound and outbound transformations to invoke. A transform program is a type of PeopleSoft Application Engine program that can convert data from one format to another; for example, from XML to a flat file. Use a transform program when one node sends a request or response message with a data structure different from the structure required by the other node. You must decide, based on your environment, to change, remove, or add transform programs. The BILLING_INVOICE_NOTICE_EDI_810 routing definition is delivered with two transform programs. The EDI_810_O transform program converts outbound invoice data from the standard PeopleSoft XML format to the EDI X.12 810 transaction format (still in XML). The XML_TO_FILE transform program converts the EDI X.12 810 formatted data from XML to a flat file format. You can remove the XML_TO_FILE transform program to send your data in the XML EDI X.12 810 format. If you are not using EDI then you will want to use the BILLING_INVOICE_NOTICE_V4 routing definition instead.

The transform program to convert data from the current version of a service operation to an older version is located on the Service Operation Version page of the non-default version. Select the non-default version on the Service Operations-General page to access the Service Operation Version page.

Node Definitions Page

Use the Node Definitions page (IB_NODE) to activate node used by the service operation.

Navigation:

PeopleTools, Integration Broker, Integration Setup, Nodes, Node Definitions

This example illustrates the fields and controls on the Node Definitions page. You can find definitions for the fields and controls later on this page.

The screenshot displays the 'Node Definitions' page with the following fields and controls:

- Node Name:** CUST
- *Description:** Portal Node - CUST
- *Node Type:** PIA (dropdown menu)
- *Authentication Option:** None (dropdown menu)
- *Default User ID:** VP1
- Hub Node:** (empty text field)
- Master Node:** (empty text field)
- Company ID:** (empty text field)
- IB Throttle Threshold:** (empty text field)
- Image Name:** (empty text field)
- Codeset Group Name:** (empty text field)
- Default Local Node:**
- Local Node:**
- Active Node:**
- Non-Repudiation:**
- Segment Aware:**
- Buttons:** Copy Node (top right), Save (bottom left), Contact/Notes (bottom center), Properties (bottom center)

Verify the Active Node check box has been selected for any nodes used in the routings that you activated on the Service Operations-Routings page for BILLING_INVOICE_NOTICE service operation.

Nodes-Connectors Page

Use the Nodes-Connectors page (IB_NODECONN) to for an outbound service operation, verify the node is connected to the correct network.

Navigation:

PeopleTools, Integration Broker, Integration Setup, Nodes, Connectors

This example illustrates the fields and controls on the Nodes-Connectors page. You can find definitions for the fields and controls later on this page.

The screenshot shows a web interface for configuring connectors. At the top, there are tabs for 'Node Definitions', 'Connectors', 'Portal', 'WS Security', and 'Routings'. The 'Connectors' tab is active. Below the tabs, the 'Node Name' is set to 'CUST', and there is a 'Ping Node' button. A 'Details' section contains the following fields:

- Gateway ID:** LOCAL
- Connector ID:** PSFTTARGET
- *Delivery Mode:** Guaranteed Delivery

To the right of these fields, there is a note: 'PeopleSoft Nodes are configured via the Gateway Setup Properties'. Below the fields, a message reads: 'This connector does not have properties. Use Gateways Page to setup.' A 'Save' button is located at the bottom left of the form.

For an outbound service operation, verify the node or routing is connected to the correct network using the Gateway ID and Connector ID fields. Depending on the file output location, you may need a password. If a password is needed, you should use the password encryption utility on this page.

Note: Your database administrator will need to assist you with this setup.

Batch Publish Rules Page

Use the Batch Publish Rules page (EO_MSGPUBATCH) to activate the batch publish rule for the publication messages you create.

This rule includes instructions on message chunking, if necessary.

Navigation:

Enterprise Components > Integration Definitions > Batch Publish Rules

This example illustrates the fields and controls on the Batch Publish Rules page. You can find definitions for the fields and controls later on this page.

For the BILLING_INVOICE_NOTICE message name (service operation):

1. Select *Active* **Status** to activate this publish rule definition for this message.
2. Select the appropriate **Output Format**.

The PeopleSoft Application Engine program can create either an Extensible Markup Language (XML) message that flows through PeopleSoft Integration Broker or a flat file generated on the PeopleSoft Process Scheduler server and not published elsewhere.

3. If you want to use message chunking, configure a chunking rule and then enter it in the **Chunking Rule ID** field.

Customer ID Chunk Page

Use the Customer ID Chunk page (OM_CHUNKCUSTID) to set up chunking for the batch publish rule.

Navigation:

SCM Integrations > Chunking Rule > CustID to Node Mapping

This example illustrates the fields and controls on the Customer ID Chunk page. You can find definitions for the fields and controls later on this page.

If using chunking for the batch publish rule, set up the chunking rule mapping definitions. You can use a delivered chunking rule or create a new chunking rule.

The BI_CUSTOMER_ID chunking rule ID is delivered as an optional chunking rule for the Billing Invoice Notice batch publish rule. To use this chunking rule, access the Customer ID Chunk page.

Select the node for each customer that receives electronic invoice notifications.

Chunking is only needed if you have requirements to break up the outbound data and send them to different destinations based on attributes in the message such as business unit or customer ID. For example, use chunking to send a single customer's messages to a specific node setup for that trading partner. If you are using a middleware product to actually determine trading partner destinations then a single transaction with all trading partner transactions can usually be sent directly to the middleware product. You would not need to activate message chunking in this situation.

Related Links

[Setting Up Chunking](#)

Publishing Billing Invoices

This section discusses how to publish billing invoices.

Pages Used to Process the Billing Invoice EIP

<i>Page Name</i>	<i>Definition Name</i>	<i>Usage</i>
Publish Outbound Message Page	IN_RUN_PUB_MSG	Initiate the outbound message publish process for outbound SCM messages that use the batch publish design pattern.
Billing Invoice Notice Message Selection Criteria Page	BI_INVMSG_SEL_PNL	Launch the Billing Invoice Notice outbound transaction.

Related Links

"Understanding EDI Transactions" (PeopleSoft Billing)

Publish Outbound Message Page

Use the Publish Outbound Message page (IN_RUN_PUB_MSG) to initiate the outbound message publish process for outbound SCM messages that use the batch publish design pattern.

Navigation:

SCM Integrations > Publish Outbound Message

This example illustrates the fields and controls on the Publish Outbound Message page. You can find definitions for the fields and controls later on this page.

The screenshot shows the 'Publish Outbound Message' page. At the top, there are tabs for 'Run Control ID', 'Publish', 'Report Manager', and 'Process Monitor', along with a 'Run' button. Below these is a 'Language' dropdown menu currently set to 'English'. The page is organized into several panels of message categories, each with a list of checkboxes:

- Inventory Messages:** Balance Notification, Advanced Shipping Notices, Interunit Expected Receipts, Internal Location Exp Receipts, Item Status Change, TMS Order Release, GTIN Data Notification, VMI Interunit Expected Receipt.
- Purchasing Messages:** Request for Quotation, Purchase Order Dispatch, Return To Vendor (Supplier), PO Expected Receipts.
- Manufacturing Messages:** Production Order Update, Item Revision, Replenish Request Dispatch.
- Order Management Messages:** Sales Order Acknowledgement, Sales Order Change Notice, Sales Quote Notice, Product Price List, Sales Order/Quote Status.
- Billing Messages:** Billing Invoice Notice (checked).
- Supplier Contract Management:** Supplier Contract Syndication.

Select the **Billing Invoice Notice** check box, and click the **Billing Invoice Notice** link to access the Billing Invoice Notice Message Selection Criteria page.

This example illustrates the fields and controls on the Billing Invoice Notice Message Selection Criteria. You can find definitions for the fields and controls later on this page.

Enter a **Request ID**, **Description**, and **Business Unit**.

Field or Control	Description
Re-transmission	Select to indicate that you want to re-transmit selected invoices. When the Publish Outbound Message process completes, it clears the BI_HDR_EC table. If you need to re-transmit invoices, the Re-transmission check box is available on this page. When you select this check box, additional selection fields appear on the page. The system rewrites the specified invoices to the BI_HDR_EC table, which is processed and transmitted again.

For technical details about individual EIPs, use the Interactive Services Repository (ISR) in the My Oracle Support website located at <https://support.oracle.com/CSP/ui/flash.html>.

Related Links

"Understanding EDI Transactions" (PeopleSoft Billing)

Helpful Hints for Integration With PeopleSoft Supply Chain Management

Understanding This Troubleshooting EIPs

This section provides answers to some common questions that arise when setting up and using PeopleSoft Enterprise Integration Points (EIPs).

Note: The information provided here should not be construed as consulting or implementation advice for your specific industry or your individual organization. The information here should be adapted or even disregarded based on the needs of your organization. PeopleSoft does not guarantee that the information included here will work as intended within your customized environment.

Helpful Hints About EIPs

The proper setup of your EIPs play a key role in any integration strategy. The following section is designed to answer common questions about EIP setup and processing.

Finding More Information About EIPs

Problem: Where can I find additional information about service operations, including more technical details?

Solution: Use the Interactive Services Repository (ISR) in the My Oracle Support website located at <https://support.oracle.com/CSP/ui/flash.html>.

The ISR contains information about the numerous EIPs. Developers use ISR to document the technical structure of an integration point, its design patterns, and underlying technology. Analysts will use ISR to explore and understand integration points from a business process context. This is especially useful when implementing an Oracle-supported reference business process across multiple products and release versions.

Monitoring the Transactions

Problem: How can I tell if my service operation transaction was completed successfully?

Solution: Use the Service Operations Monitor located in PeopleTools, Integration Broker, Service Operations Monitor. Use these pages to view items in the integration system at a high level so that you can isolate particular areas and then drill down for further information. You can select to group information by queue or service operation.

Services and Service Operations

Problem: What is the difference between a service and a service operation?

Solution: Services are used to logically group a set of service operations. For example, if you have a number of service operations that are related to customers, such as those pertaining to customer information, adding customers, updating customers, deleting customers, and so on, you can create a customer web service and then associate the related service operations with that service.

Warning! PeopleSoft delivers two services with PeopleSoft Integration Broker: IB_GENERIC and IB_UTILITY. These services are used internally by the system. Do not delete or modify these services.

OnRoute Handlers

Problem: Why OnRoute handlers are required when setting up an operation?

Solution: If you are using the chunking features of the Batch Publish utility for outbound integrations, you may want to use an OnRoute Handler to direct different chunks of data to different trading partners. If you are integrating to a single trading partner then you will probably not have a need for this Handler.

Routing Definitions

Problem: On the Routing Definition, is it required to specify a transform?

Solution: Most likely you will not need a transform unless you have done your own customizations. Integrations with a service operation version other than the default require a transform to or from the default version. Additionally, in a few of the integrations, transforms are used to convert the default service operation version to or from industry standard formats such as xcbl, cxml, or X.12 EDI.

Nodes

Problem: Why is it necessary to set up a location for nodes other than the local node? If so, what should this address be?

Solution: If integrating to or from external sources, use the http target connector and enter the URL of the external source in the connector properties. If integrating to another PeopleSoft database, use the PeopleSoft target connector and configure the selected gateway to point to an application server running pub/sub services on the target database.

SimpleFileTargetConnector -vs- Flat Files

Problem: What is the difference between using the SimpleFileTargetConnector on the gateway or using the Batch Publish Rule's Output Format of "Flat File"?

Solution: When using the SimpleFileTargetConnector in integration broker the gateway creates a file in the directory assigned to the node. When using the Flat File option on the batch publish rule, a service operation instance is never published. Instead, the Batch Publish utility generates a flat file in the format designated by the File Layout Definition named the same as the message. The file is placed in the default directory on the process scheduler server running the Outbound File Publish program.

FTP Servers

Problem: Can I have the files written to a FTP server instead of a directory specified in the properties of the SimpleFileTargetConnector?

Solution: Yes, by configuring the FtpTargetConnector on the node definition instead of the SimpleFileTargetConnector.

Chunking

Problem: When do I need to use chunking?

Solution: Chunking is only needed if you have requirements to break messages up by trading partner. If you are using a middleware product to actually determine trading partner destinations, a single message with all trading partner transactions can usually be sent directly to the middleware product.

Helpful Hints about Integration Broker in PeopleTools 8.48 and Higher

In PeopleTools 8.48, the Integration Broker architecture was changed. This section provides the answers to some frequently asked questions about the changes.

Message Properties

Problem: Starting with PeopleTools 8.48, I cannot view or change properties on my messages in application designer. How do I change or activate messages and any associated PeopleCode?

Solution: The status of integrations was moved from the message to the service operation, so you now have to activate the service operation instead of the message. PeopleCode events were also moved to the service operation and renamed to handlers.

Chunking

Problem: In prior versions I had to attach OnRoute PeopleCode to my message when enabling chunking. Do I use the same PeopleCode as a service operation handler?

Solution: The chunking PeopleCode from prior releases will no longer function starting with PeopleTools 8.48. Service operations intended to support chunking are now delivered with an inactive OnRoute handler. This allows a user to activate the chunking PeopleCode rather than having to create PeopleCode in the application designer.

Channels

Problem: Starting with PeopleTools 8.48, I cannot find Message Channels. What happened to them?

Solution: In PeopleTools 8.48, Message Channels were renamed to Queues.

Transactions

Problem: Starting with PeopleTools 8.48, I cannot find my transactions. Does this mean I no longer have to create or activate them?

Solution: In PeopleTools 8.48, Transactions were renamed to Service Operation Routings. Routings must still be activated to enable an integration.

Relationship Transactions

Problem: Starting with PeopleTools 8.48, I cannot find my Relationships or relationship transactions. How do I enable transforms?

Solution: In PeopleTools 8.48, transforms were moved to the routing definition, and non-default service operation versions. They are now enabled when the routing is activated. Relationships and relationship transactions have been deprecated.