PeopleSoft FSCM 9.2: PeopleSoft Supply Chain Management Common Information

September 2022

This software and related documentation are provided under a license agreement containing restrictions on use and disclosure and are protected by intellectual property laws. Except as expressly permitted in your license agreement or allowed by law, you may not use, copy, reproduce, translate, broadcast, modify, license, transmit, distribute, exhibit, perform, publish, or display any part, in any form, or by any means. Reverse engineering, disassembly, or decompilation of this software, unless required by law for interoperability, is prohibited.

The information contained herein is subject to change without notice and is not warranted to be error-free. If you find any errors, please report them to us in writing.

If this is software, software documentation, data (as defined in the Federal Acquisition Regulation), or related documentation that is delivered to the U.S. Government or anyone licensing it on behalf of the U.S. Government, then the following notice is applicable:

U.S. GOVERNMENT END USERS: Oracle programs (including any operating system, integrated software, any programs embedded, installed, or activated on delivered hardware, and modifications of such programs) and Oracle computer documentation or other Oracle data delivered to or accessed by U.S. Government end users are "commercial computer software," "commercial computer software documentation," or "limited rights data" pursuant to the applicable Federal Acquisition Regulation and agency-specific supplemental regulations. As such, the use, reproduction, duplication, release, display, disclosure, modification, preparation of derivative works, and/or adaptation of i) Oracle programs (including any operating system, integrated software, any programs embedded, installed, or activated on delivered hardware, and modifications of such programs), ii) Oracle computer documentation and/or iii) other Oracle data, is subject to the rights and limitations specified in the license contained in the applicable contract. The terms governing the U.S. Government's use of Oracle cloud services are defined by the applicable contract for such services. No other rights are granted to the U.S. Government.

This software or hardware is developed for general use in a variety of information management applications. It is not developed or intended for use in any inherently dangerous applications, including applications that may create a risk of personal injury. If you use this software or hardware in dangerous applications, then you shall be responsible to take all appropriate fail-safe, backup, redundancy, and other measures to ensure its safe use. Oracle Corporation and its affiliates disclaim any liability for any damages caused by use of this software or hardware in dangerous applications.

Oracle®, Java, and MySQL are registered trademarks of Oracle and/or its affiliates. Other names may be trademarks of their respective owners.

Intel and Intel Inside are trademarks or registered trademarks of Intel Corporation. All SPARC trademarks are used under license and are trademarks or registered trademarks of SPARC International, Inc. AMD, Epyc, and the AMD logo are trademarks or registered trademarks of Advanced Micro Devices. UNIX is a registered trademark of The Open Group.

This software or hardware and documentation may provide access to or information about content, products, and services from third parties. Oracle Corporation and its affiliates are not responsible for and expressly disclaim all warranties of any kind with respect to third-party content, products, and services unless otherwise set forth in an applicable agreement between you and Oracle. Oracle Corporation and its affiliates will not be responsible for any loss, costs, or damages incurred due to your access to or use of third-party content, products, or services, except as set forth in an applicable agreement between you and Oracle.

Documentation Accessibility

For information about Oracle's commitment to accessibility, visit the Oracle Accessibility Program website at <https://docs.oracle.com/pls/topic/lookup?ctx=acc&id=docacc>.

Access to Oracle Support

Oracle customers that have purchased support have access to electronic support through My Oracle Support. For information, visit <https://docs.oracle.com/pls/topic/lookup?ctx=acc&id=info> or visit <https://docs.oracle.com/pls/topic/lookup?ctx=acc&id=trs> if you are hearing impaired.

Contents

- Preface: Preface.....vii**
 - Understanding the PeopleSoft Online Help and PeopleBooks..... vii
 - Hosted PeopleSoft Online Help..... vii
 - Locally Installed Help..... vii
 - Downloadable PeopleBook PDF Files.....vii
 - Common Help Documentation..... vii
 - Field and Control Definitions..... viii
 - Typographical Conventions.....viii
 - ISO Country and Currency Codes.....viii
 - Region and Industry Identifiers..... ix
 - Translations and Embedded Help..... ix
 - Using and Managing the PeopleSoft Online Help..... x
 - PeopleSoft FSCM Related Links.....x
 - Contact Us.....x
 - Follow Us.....x
- Chapter 1: Getting Started with Supply Chain Management Common Information..... 13**
 - PeopleSoft Supply Chain Management Common Information Overview..... 13
 - PeopleSoft Supply Chain Management Common Information Implementation..... 13
 - Common Elements Used in Supply Chain Management Common Information..... 14
- Chapter 2: Setting Up Delivery Management and Freight Calculations..... 17**
 - Understanding PeopleSoft Delivery Management and Freight Calculations..... 17
 - Setting Up Delivery Management..... 17
 - Pages Used to Set Up Delivery Management.....19
 - Understanding the Delivery Management Setup Steps.....21
 - Understanding How Deliveries Are Created..... 22
 - Setting Up Basic Information for Freight Charges..... 23
 - Pages Used to Set Up Basic Information for Freight Charges..... 33
 - Entering Freight Charges Manually.....34
 - Applying Freight Charges to Deliveries and Orders.....36
 - Receiving Freight Charges..... 36
 - Applying Freight Charges to the Order Level..... 39
 - Committing Freight Charges to PeopleSoft Billing and Cost Management.....41
 - Using PeopleSoft Tables to Store Delivery and Freight Information.....43
- Chapter 3: Defining External Third-Party Freight Integration..... 49**
 - Understanding External Third-Party Freight Integration..... 49
 - The Building Blocks of External Third-Party Freight.....49
 - Examples of Third-Party Freight..... 51
 - Example 1: Interactive Rate Shopping at Order Entry Time.....52
 - Example 2: Best Way at Order Entry Time.....53
 - Example 3: Specific Carrier at Order Entry Time.....54
 - Example 4: Batch Assignment of Freight Charges on Incoming EDI Sales Orders.....55
 - Example 5: Interactive Freight Calculation at Shipping Time..... 57
 - Example 6: Batch Assignment of Freight Charges and Manifest Data at Shipping Time..... 60
 - Setting Up External Third-Party Freight Charges.....62
 - Pages Used to Set Up Third-Party Freight Charges.....69
 - Maintain Freight Types Page..... 70

Maintain Freight Services Page.....	71
Enabling the PeopleSoft EIPs for Third-Party Freight.....	72
Pages Used to Integrate PeopleSoft with the Third-Party Freight System.....	75
Message Definition Page.....	75
Chapter 4: Using the Internal PeopleSoft Freight Calculator.....	79
Understanding Internal Freight Charges.....	79
Setting Up the PeopleSoft Internal Freight Calculator.....	79
Pages Used to Set Up the PeopleSoft Internal Freight Calculator.....	81
Chapter 5: Using Delivery Management and Freight Calculations.....	83
Understanding Delivery Management and Freight Calculations.....	83
Using the Delivery Management Workbench.....	83
Pages Used for the Delivery Management Workbench.....	84
Common Elements Used in This Section.....	85
Delivery Management Workbench- Workbench Navigation Menu Page.....	90
Delivery Management Workbench-Deliveries Page.....	91
Delivery Management Workbench-Demand / Container Activities Page.....	95
Delivery Management Workbench-Manage Delivery Page.....	99
Delivery Management Workbench- Demand / Container Selection Page.....	111
Delivery Management Workbench- Packages Page.....	112
Delivery Management Workbench- Message / Error Log Page.....	114
Using the Freight Request Component.....	115
Pages Used for the Freight Request Component.....	115
Calculate Freight Page.....	116
Freight Results Page.....	119
Freight Results Detail Page.....	121
Running the Process Deliveries/Freight Process.....	122
Page Used to Run the Process Deliveries/Freight Process.....	122
Process Deliveries/Freight Page.....	122
Process Deliveries/Freight Process Page.....	131
Sending Freight Requests to the Third-Party Freight System.....	135
Receiving Freight Data from the Third-Party Freight System.....	136
Pages Used to Receive Freight Data from the Third-Party Freight System.....	137
Synchronous Services Page.....	139
Fulfillment Requests Page.....	140
Transaction Maintenance Page.....	142
Transaction Maintenance- Freight Page.....	144
Chapter 6: Pegging Supply and Demand.....	149
Understanding Pegging.....	149
Rules for Items.....	150
Understanding Peg Chains.....	150
Pegging in PeopleSoft Inventory.....	152
Pegging a Material Stock Request.....	152
Receiving Pegged Supply into PeopleSoft Inventory.....	155
Pegging in PeopleSoft Order Management.....	158
Pegging in PeopleSoft Maintenance Management.....	167
Pegging a Work Order with an Inventory Item ID.....	168
Pegging a Work Order with a Non-Inventory Item.....	171
Pegging in PeopleSoft Purchasing.....	173
Pegging in PeopleSoft Manufacturing.....	174
Setting Up Pegging.....	174
Pages Used to Set Up Pegging.....	175

Pegging Setup Page.....	175
Pegging Item Setup Page.....	177
User Security Page.....	178
Setting Up the Putaway Location for Pegged Supply.....	181
Setting Up Notifications.....	182
Using the Pegging Workbench.....	184
Pages Used for the Pegging Workbench.....	185
Search - Pegging Workbench Page.....	186
Pegging Workbench Page.....	188
Changing Peg Chains.....	193
Monitoring Peg Chains.....	194
Pages Used to Monitor Pegs.....	195
Search - Pegging Inquiry Page.....	195
Details - Pegging Inquiry Page.....	196
Pegging Exception Report Page.....	197
Chapter 7: Implementing the Oracle Search Framework Search Engine.....	201
Understanding the Search Framework Search Engine.....	201
Chapter 8: Working with the Printable Documents Framework.....	203
Understanding the Printable Documents Framework.....	203
The Printable Documents Framework.....	203
The Printable Document Object.....	204
Printable Document Object Methods and Properties.....	205
Using the Printable Documents Framework.....	209
Pages Used for the Printable Documents Framework.....	209
Chapter 9: Understanding Business Intelligence Publisher for Picking Plan and Goods Receipts reports.....	211
Understanding BI Publisher Picking Plan and Goods Receipts Reports.....	211
Understanding BI Publisher Picking Plan and Goods Receipts Structure.....	211
Setting Up BI Publisher Picking Plan and Goods Receipts Reports.....	211

Preface

Understanding the PeopleSoft Online Help and PeopleBooks

The PeopleSoft Online Help is a website that enables you to view all help content for PeopleSoft applications and PeopleTools. The help provides standard navigation and full-text searching, as well as context-sensitive online help for PeopleSoft users.

Hosted PeopleSoft Online Help

You can access the hosted PeopleSoft Online Help on the [Oracle Help Center](#). The hosted PeopleSoft Online Help is updated on a regular schedule, ensuring that you have access to the most current documentation. This reduces the need to view separate documentation posts for application maintenance on My Oracle Support. The hosted PeopleSoft Online Help is available in English only.

To configure the context-sensitive help for your PeopleSoft applications to use the Oracle Help Center, see [Configuring Context-Sensitive Help Using the Hosted Online Help Website](#).

Locally Installed Help

If you're setting up an on-premise PeopleSoft environment, and your organization has firewall restrictions that prevent you from using the hosted PeopleSoft Online Help, you can install the online help locally. See [Configuring Context-Sensitive Help Using a Locally Installed Online Help Website](#).

Downloadable PeopleBook PDF Files

You can access downloadable PDF versions of the help content in the traditional PeopleBook format on the [Oracle Help Center](#). The content in the PeopleBook PDFs is the same as the content in the PeopleSoft Online Help, but it has a different structure and it does not include the interactive navigation features that are available in the online help.

Common Help Documentation

Common help documentation contains information that applies to multiple applications. The two main types of common help are:

- Application Fundamentals
- Using PeopleSoft Applications

Most product families provide a set of application fundamentals help topics that discuss essential information about the setup and design of your system. This information applies to many or all applications in the PeopleSoft product family. Whether you are implementing a single application, some combination of applications within the product family, or the entire product family, you should be familiar with the contents of the appropriate application fundamentals help. They provide the starting points for fundamental implementation tasks.

In addition, the *PeopleTools: Applications User's Guide* introduces you to the various elements of the PeopleSoft Pure Internet Architecture. It also explains how to use the navigational hierarchy, components, and pages to perform basic functions as you navigate through the system. While your application or implementation may differ, the topics in this user's guide provide general information about using PeopleSoft applications.

Field and Control Definitions

PeopleSoft documentation includes definitions for most fields and controls that appear on application pages. These definitions describe how to use a field or control, where populated values come from, the effects of selecting certain values, and so on. If a field or control is not defined, then it either requires no additional explanation or is documented in a common elements section earlier in the documentation. For example, the Date field rarely requires additional explanation and may not be defined in the documentation for some pages.

Typographical Conventions

The following table describes the typographical conventions that are used in the online help.

<i>Typographical Convention</i>	<i>Description</i>
Key+Key	Indicates a key combination action. For example, a plus sign (+) between keys means that you must hold down the first key while you press the second key. For Alt+W , hold down the Alt key while you press the W key.
... (ellipses)	Indicate that the preceding item or series can be repeated any number of times in PeopleCode syntax.
{ } (curly braces)	Indicate a choice between two options in PeopleCode syntax. Options are separated by a pipe ().
[] (square brackets)	Indicate optional items in PeopleCode syntax.
& (ampersand)	When placed before a parameter in PeopleCode syntax, an ampersand indicates that the parameter is an already instantiated object. Ampersands also precede all PeopleCode variables.
⇒	This continuation character has been inserted at the end of a line of code that has been wrapped at the page margin. The code should be viewed or entered as a single, continuous line of code without the continuation character.

ISO Country and Currency Codes

PeopleSoft Online Help topics use International Organization for Standardization (ISO) country and currency codes to identify country-specific information and monetary amounts.

ISO country codes may appear as country identifiers, and ISO currency codes may appear as currency identifiers in your PeopleSoft documentation. Reference to an ISO country code in your documentation does not imply that your application includes every ISO country code. The following example is a country-specific heading: "(FRA) Hiring an Employee."

The PeopleSoft Currency Code table (CURRENCY_CD_TBL) contains sample currency code data. The Currency Code table is based on ISO Standard 4217, "Codes for the representation of currencies," and also relies on ISO country codes in the Country table (COUNTRY_TBL). The navigation to the pages where you maintain currency code and country information depends on which PeopleSoft applications you are using. To access the pages for maintaining the Currency Code and Country tables, consult the online help for your applications for more information.

Region and Industry Identifiers

Information that applies only to a specific region or industry is preceded by a standard identifier in parentheses. This identifier typically appears at the beginning of a section heading, but it may also appear at the beginning of a note or other text.

Example of a region-specific heading: "(Latin America) Setting Up Depreciation"

Region Identifiers

Regions are identified by the region name. The following region identifiers may appear in the PeopleSoft Online Help:

- Asia Pacific
- Europe
- Latin America
- North America

Industry Identifiers

Industries are identified by the industry name or by an abbreviation for that industry. The following industry identifiers may appear in the PeopleSoft Online Help:

- USF (U.S. Federal)
- E&G (Education and Government)

Translations and Embedded Help

PeopleSoft 9.2 software applications include translated embedded help. With the 9.2 release, PeopleSoft aligns with the other Oracle applications by focusing our translation efforts on embedded help. We are not planning to translate our traditional online help and PeopleBooks documentation. Instead we offer very direct translated help at crucial spots within our application through our embedded help widgets. Additionally, we have a one-to-one mapping of application and help translations, meaning that the software and embedded help translation footprint is identical—something we were never able to accomplish in the past.

Using and Managing the PeopleSoft Online Help

Select About This Help in the left navigation panel on any page in the PeopleSoft Online Help to see information on the following topics:

- Using the PeopleSoft Online Help.
- Managing hosted Online Help.
- Managing locally installed PeopleSoft Online Help.

PeopleSoft FSCM Related Links

[Oracle Help Center](#)

[Hosted Online Help](#)

[PeopleSoft Information Portal](#)

[My Oracle Support](#)

Financial and Supply Chain Management information for Search Framework search engine can be found in PeopleSoft Application Fundamentals documentation. For application specific information, see the "Understanding Search Pages within Components " (Application Fundamentals) topic.

[PeopleSoft Training from Oracle University](#)

[PeopleSoft Video Feature Overviews on YouTube](#)

[PeopleSoft Business Process Maps \(Microsoft Visio format\)](#)

[PeopleSoft Spotlight Series](#)

Contact Us

Send your suggestions to pssoft-infodev_us@oracle.com.

Please include the applications update image or PeopleTools release that you're using.

Follow Us

<i>Icon</i>	<i>Link</i>
	<u>YouTube</u>

Icon	Link
	Twitter@PeopleSoft_Info.
	PeopleSoft Blogs
	LinkedIn

Chapter 1

Getting Started with Supply Chain Management Common Information

PeopleSoft Supply Chain Management Common Information Overview

Use this documentation for common information about:

- Setting up and using delivery management.
 - Setting up and using freight calculations.
 - Pegging supply and demand.
 - Implementing the Oracle Search Framework search engine.
 - Working with the printable documents framework.
-

PeopleSoft Supply Chain Management Common Information Implementation

PeopleSoft Setup Manager enables you to review a list of setup tasks for your organization for the products that you are implementing. The setup tasks include the components that you must set up, listed in the order in which you must enter data into the component tables, and links to the corresponding documentation.

Other Sources of Information

In the planning phase of your implementation, take advantage of all PeopleSoft sources of information, including the installation guides, table-loading sequences, data models, and business process maps. A complete list of these resources appear in the preface of the *PeopleSoft Application Fundamentals* with information about where to find the most current version of each.

Common Elements Used in Supply Chain Management Common Information

Field or Control	Description
As of Date	The first date for which a report or process includes data.
BU or Business Unit	An identification code that represents a high-level organization of business information. You can use a business unit to define regional or departmental units within a larger organization.
Description	Free flow text up to 256 characters.
Short Description	Free flow text up to 15 characters.
Effective Date	Date that a table row becomes effective; the date that an action begins. For example, if you want to close a ledger on June 30, the effective date for the ledger closing would be July 1. This date also determines when you can view and change the information. Pages and batch processes that use the information use the current row. <i>See PeopleTools: Applications User's Guide</i>
Language or Language Code	The language of the field labels and report headings of reports to print. The field values appear as you enter them. Language also refers to the language spoken by an employee, applicant, or non-employee.
Process Frequency	Designates the appropriate frequency to process: <i>Once:</i> Executes the request the next time the batch process runs. After the batch process runs, the process frequency is automatically set to <i>Don't Run</i> . <i>Always Executes:</i> Executes the request every time the batch process runs. <i>Don't Run:</i> Ignores the request when the batch process runs.
Process Monitor	View the status of submitted process requests. <i>See PeopleTools: Process Scheduler</i>
Report ID	The report identifier.
Report Manager	View report content, check the status of a report, and see detailed messages. <i>See PeopleTools: Process Scheduler</i>

Field or Control	Description
Run Control ID	A request identification that represents a set of selection criteria for a report or process.
Run	Specify the location where a process or job runs and the process output format.
Status	Check the progress of a report or process. A valid status is <i>Posted, Not Posted, Generated, Processing, or Scheduled</i> .
User ID	The system identifier for the individual who generates a transaction.
Instance or Prcs Instance (instance or process instance)	The number that represents where the request is in the queue.

PeopleTools: Lifecycle Management Guide

Chapter 2

Setting Up Delivery Management and Freight Calculations

Understanding PeopleSoft Delivery Management and Freight Calculations

The delivery management and freight calculation features in PeopleSoft Inventory and Order Management enable you to group items for shipment and apply freight charges. The freight feature applies only to sales orders and quotes from PeopleSoft Order Management.

These features include:

- *Delivery*: Deliveries are logical groupings of demand lines that can be shipped together. PeopleSoft Inventory and Order Management can use these groupings for pricing sales orders, performing fulfillment activities, adding freight charges, and packing shipping containers (both material stock requests and sales orders). Each delivery is assigned a unique delivery ID.
- *Freight Calculation*: Freight charges can be applied to a sales order using:
 - *Integration to Third-Party Freight Provider*: Using PeopleSoft EIPs (enterprise integration points), you can send deliveries to a third-party freight provider and receive back freight charges into PeopleSoft Inventory or Order Management. Multiple ways are available to configure this interface.
 - *Internal PeopleSoft Freight Calculation*: Using arbitration plans, freight rules, and freight breaks within PeopleSoft Order Management and PeopleSoft Inventory, you can design the system to calculate and apply the freight costs to deliveries assigned to sales orders.
 - *Manual Entry of Freight Costs*: Using the **Freight Amount** field located on several pages and process pages within PeopleSoft Order Management and PeopleSoft Inventory, you can manually enter freight charges for deliveries and sales orders.

Deliveries are required for the internal or third-party freight calculation features.

Setting Up Delivery Management

Delivery management enables you to assemble demand lines together into a delivery so that the lines can be priced, freighted, or shipped as a group. Each delivery is uniquely identified by a delivery ID. Deliveries can be managed automatically by the system as demand lines are added or modified in the sales order or while the system is performing other fulfillment processing including shipping. If possible, the system adds demand lines to an existing delivery. The system can also move modified demand lines to

another existing delivery. If new or modified demand lines cannot be placed in an existing delivery, then the system creates a new delivery. A delivery is used to:

- Calculate weight and volume pricing for sales orders using PeopleSoft Order Management and PeopleSoft Enterprise Pricer.
- Calculate freight costs for sales orders.
- Perform fulfillment activities.
- Pack items into shipping containers using the Packing Session component in PeopleSoft Inventory.

Note: You cannot split shipping containers across deliveries; once a container has been assigned to a delivery ID, everything in that container must belong to the same delivery.

The delivery can be created:

- Manually by a user with access to the Delivery Management Workbench component.
- Automatically by the system when a sales order is saved or changed.
- By the Order Completion process (OM_BACKGRND) in PeopleSoft Order Management.
- Automatically, in the Shipping/Issues component in PeopleSoft Inventory.
- By selecting the automatic delivery management option in the Fulfillment Workbench, Material Picking Feedback component, Picking Confirmation process page, Front End Shipping Requests process page, or Shipping Requests process page. In addition, the automatic delivery management option is available on the following inbound fulfillment engine EIPs: Inventory_Pick_Confirm, Inventory_Front_End_Shipping, and Inventory_Shipping.
- By running the Process Deliveries/Freight process (IN_FUL_DEL).

Delivery information can be stored at three levels:

- *Delivery Level:* Delivery information is stored within a delivery. One delivery can include several demand lines, shipping containers, packages, or a mixture of all three types. Freight status, freight amounts, and tracking numbers can also be added or updated for a complete delivery. Individual shipping containers or packages within a delivery can also have freight and tracking number assignments.
- *Container Level:* A shipping container includes a group of demand lines and possibly other smaller shipping containers that are shipping in the same container, such as a pallet. Inventory tracks the individual demand lines that are in the shipping container. Shipping containers are included within a delivery. One or more shipping containers can be included in one delivery ID along with any additional demand lines or packages outside of containers. The demand lines within one shipping container cannot be split across multiple deliveries; once a shipping container has been assigned to a delivery ID, everything in that container must belong to the same delivery ID. Freight status, freight amounts, and tracking number can be managed at the shipping container level.

In PeopleSoft Inventory, you can create two kinds of containers: storage containers, which facilitate the storage and movement of stock within a business unit; and shipping containers, which consolidate stock for shipment. For the delivery and freight features, the system uses shipping containers.

- *Package Level:* Packages are included within a delivery. A *package* is one shippable entity that is usually known as a parcel or a single box. The package is similar to the shipping container except that PeopleSoft Inventory does not track the individual demand line assignments in the package. Freight status, freight amounts, and tracking number can be managed at the package level.

Pages Used to Set Up Delivery Management

<i>Page Name</i>	<i>Definition Name</i>	<i>Usage</i>
"Order Entry Features Page" (PeopleSoft Order Management)	BUS_UNIT_TBL_OM9	Determine when a delivery ID should be applied to the demand line of a sales order line or quote. You can choose to create or update deliveries when a user saves a new sales order or quote or changes a field on an existing order or quote, and the Order Completion process (OM_BACKGRND) is run.
"Shipping and Returns Page" (PeopleSoft Order Management)	BUS_UNIT_TBL_OM6	At the business unit level, select the value of <i>Yes</i> in the Deliveries Restricted to Order field to require that all of the demand lines assigned to one delivery must be from the same sales order.
TableSet Control - Record Group Page	SET_CNTRL_TABLE1	Select the SetID for the record group, IN_19, Delivery Autonumbering to link the delivery ID numbering sequence at the SetID level to the business unit (set control value). This record group is used with the Auto Numbering page.
Auto Numbering Page	AUTO_NUM_PNL	Define the automatic numbering sequence for delivery IDs. To establish one or more numbering sequences for delivery management, use the Number Type of DELV (delivery ID) and the Field Name of DELIVERY_ID. Automatic numbering applies a system-generated number to each new delivery ID when it is created in PeopleSoft Inventory and PeopleSoft Order Management. When you use automatic numbering, you define the starting sequence for the delivery ID, and when the system creates a new delivery ID, it assigns the prefix for the starting sequence, plus the remaining numbering scheme for the ID.
Order Group Shipping Terms Page	ORD_GROUP_TERMS	At the order group level, select the value of <i>Yes</i> in the Deliveries Restricted to Order field to require that all of the demand lines assigned to one delivery must be from the same sales order.

Page Name	Definition Name	Usage
General Information-Ship To Options Page	CUST_SHIPTO_OPT1	At the customer level, select the value of <i>Yes</i> in the Deliveries Restricted to Order field to require that all of the demand lines assigned to one delivery must be from the same sales order.
Buying Agreements - Header Terms Page	SCON_HDR_TRMS	At the buying agreement level, select the value of <i>Yes</i> in the Deliveries Restricted to Order field to require that all of the demand lines assigned to one delivery must be from the same sales order.
"Setup Fulfillment-Delivery/Freight Page" (PeopleSoft Inventory)	OF_SETUP10_INV	Enable delivery management for the Inventory business unit and to define options for the delivery and freight features within this Inventory business unit.
Inventory Definition - Business Unit Options: Delivery Management Page	INV_SHP_FIELDS	Enter the fields used to build a delivery. When the system groups demand lines together to create a delivery, certain fields must be the same on all the demand lines, such as the same inventory (ship from) business unit and the same scheduled shipment date. Use this page to define additional fields that must match on each demand line added to one delivery ID. Both PeopleSoft Order Management and PeopleSoft Inventory use the criteria that you establish there.
"Setup Fulfillment- Demand Change Configuration Page" (PeopleSoft Inventory)	OF_SETUP9_INV	Identify the fulfillment state in which no further demand lines can be automatically added to the delivery by the system. On the row Add Lines to Deliveries, select the fulfillment state at which the system should consider the delivery closed for shipment and no longer automatically adds demand lines to that delivery. Valid fulfillment states are Unfulfilled, Releasable, Released, Confirmed, and Shipped. If any demand line on the delivery has reached the state defined, then the system no longer automatically adds new demand lines to the delivery.

Understanding the Delivery Management Setup Steps

The following diagram displays the setup steps to enable the delivery management feature. These steps involve pages in both PeopleSoft Inventory and PeopleSoft Order Management that are used to activate the delivery management feature, define the delivery, determine how delivery IDs are numbered, and determine when deliveries are created or changed.

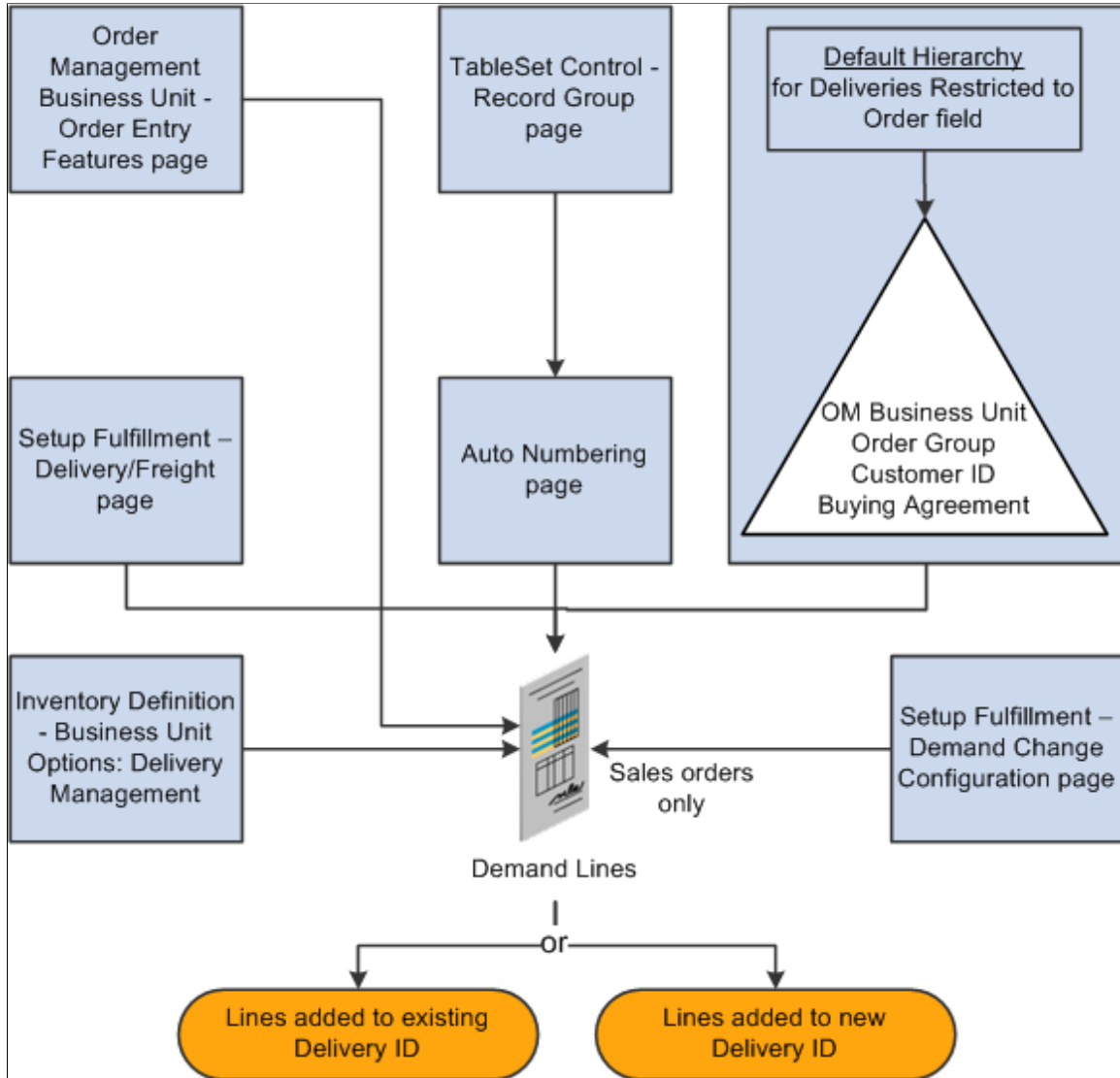

Complete the following steps to enable the delivery management feature:

- *Order Management Business Unit - Order Entry Features page:* Use this page within the Order Management business unit definition to determine when to apply a delivery ID to the demand line of a sales order or quote. You can choose to create or update deliveries when a user saves a new sales order or quote, changes a field on an existing order or quote, and when the Order Completion process is run. This setting is used only by PeopleSoft Order Management.
- *TableSet Control- Record Group page and Auto Numbering page:* Define the structure of the delivery ID numbering sequence at the SetID level. You can add multiple sequences with different prefixes to be used in different locations.

- *Deliveries Restricted to Order field:* Use this yes/no field to determine whether all of the demand lines assigned to a delivery must be from the same sales order. This is available for quotes and sales orders only. The **Deliveries Restricted to Order** field can be defined within the default hierarchy on the Shipping and Returns page of the Order Management business unit, Order Group Shipping Terms page, customer's General Information - Ship To Options page, and the Buying Agreement Form - Header Terms page. In the default hierarchy, the more specific information overrides the more general information; in this case, the setting for the **Deliveries Restricted to Order** field that is defined on a buying agreement overrides a value on a customer and the value on the customer overrides the value on the order group. A value on the order group overrides the value at the order management business unit.
- *Setup Fulfillment-Delivery/Freight page:* Use this page to enable delivery management for the Inventory business unit by selecting *Yes* or *Manual* for the **Delivery Option** field. This enables the delivery management feature for the Delivery Management Workbench and the Inventory fulfillment processes.
- *Inventory Definition - Business Unit Options: Delivery Management page:* Use this page to identify the delivery key fields needed to build a delivery in Order Management and Inventory. When the system groups demand lines together to create a delivery, certain field values must be the same on all of the demand lines, such as the same inventory business unit and the same scheduled shipment date. Use this page to define additional fields that must match on each demand line added to one delivery ID.
- *Setup Fulfillment - Demand Change Configuration:* Use this page to identify the fulfillment state in which no further demand lines can be automatically added to the delivery by the system. On the row Add Lines to Deliveries, select the fulfillment state at which the system should consider the delivery closed for shipment. If any demand line on the delivery has reached the state defined, then the system no longer automatically adds new demand lines to the delivery.

Understanding How Deliveries Are Created

You can choose to have the system assign the delivery ID when a user creates or modifies an order schedule, runs the Order Completion process, performs Inventory fulfillment processing, or saves the Shipping/Issues component. This way, at order entry time or shipping time, you can determine the number of shipments (deliveries) that you have for the orders. In addition, you can use the Delivery Management Workbench to adjust existing deliveries or create new deliveries. You can create deliveries for MSRs, sales orders, and quotes; however, you cannot mix MSRs and sales orders on the same delivery and you can use only sales order deliveries to calculate freight charges.

To group demand lines into one delivery, the demand lines must have the same value in the fields identified as delivery keys. The delivery key fields include:

- Required fields such as inventory business unit, scheduled ship date, freight charge method, and so on. For example, some fields are required when PeopleSoft Order Management and PeopleSoft Billing are installed in the database; other fields are required for performing VAT calculation.
- Optional fields that you have entered on the Inventory Definition - Business Unit Options: Delivery Management page.

For a complete list of all required and optional delivery key fields used to combine demand lines into the same delivery ID, see "Defining Business Unit Fulfillment Options" (PeopleSoft Inventory)

See "Inventory Definition - Business Unit Options: Delivery Management Page" (PeopleSoft Inventory).

When the delivery is created for demand lines with a preferred carrier (Use Preferred Freight Carrier field), then the system limits a delivery to one assigned carrier. The system assigns that carrier ID to the delivery or the system finds another delivery with the same carrier ID already assigned to it. The demand line is also flagged as preferred carrier so that other fulfillment steps will know that the customer has requested the carrier for freight. The **Use Preferred Freight Carrier** field is located on several pages in the Order Management default hierarchy.

Setting Up Basic Information for Freight Charges

Freight can be calculated internally within PeopleSoft Inventory or PeopleSoft Order Management by means of the PeopleSoft freight feature, or you can integrate with a third-party freight provider using EIPs to receive freight charges.

Understanding Freight Charges Documentation

The documentation for freight setup has been divided into three parts:

1. *Basic Setup*: This section discusses the freight setup steps that are needed for all freight configurations. The following section discusses basic setup.
2. *External Third-Party Setup*: This section discusses the additional setup steps needed to integrate PeopleSoft with a third-party freight provider. Basic setup is also required.

See [Setting Up External Third-Party Freight Charges](#).

3. *Internal Freight Calculator Setup*: This section discusses the additional setup steps to use the PeopleSoft internal freight calculator. Basic setup is also required.

See [Setting Up the PeopleSoft Internal Freight Calculator](#).

Basic Setup Steps for Freight Charges

This section discusses the common setup needed for adding freight charges to your sales orders from either the PeopleSoft internal freight calculator or the third-party freight provider. In addition to the setup discussed in this section, set up the internal freight calculation feature, the external freight calculation feature, or both.

The following diagram displays the setup steps for the basic information to enable freight charges. These steps involve pages in both PeopleSoft Inventory and PeopleSoft Order Management.

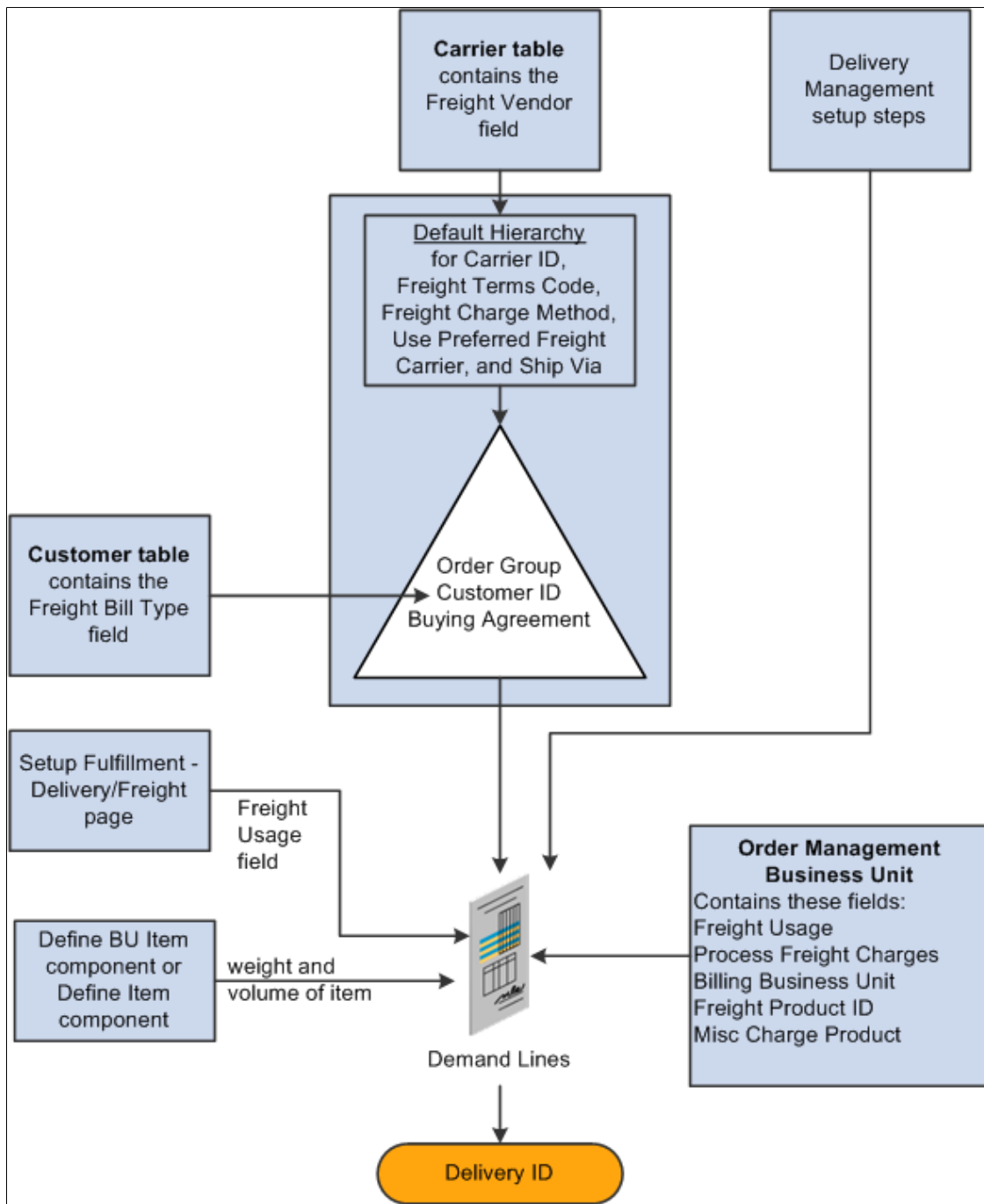

The delivery is used as the basis for freight calculation in PeopleSoft Inventory or PeopleSoft Order Management. With internal freight, the field values of the delivery determine how freight charges are calculated. With external third-party freight, the delivery structure is the mechanism used to transfer to and from the third-party freight provider. These field values are supplied by default to the delivery when it is created based on the values on the sales order demand lines grouped into the delivery. The fields that are used to group the demand lines into a delivery are defined on the Inventory business unit definition.

<i>Field or Control</i>	<i>Description</i>
Delivery Management Setup Steps	<p>Delivery management is required for both internal and external freight calculations. See the Setting Up Delivery Management section of this topic for instructions and setup steps. Set up the delivery management feature before using the freight charges feature.</p> <p>See Setting Up Delivery Management.</p>

Field or Control	Description
<p>Freight Bill Type</p>	<p>Specify which freight amount should be billed to the customer. The Populate Billing process (OMBILL) uses this field to determine which freight charge to send to PeopleSoft Billing to be placed on the customer's invoice. Whichever option you use, freight can be calculated or shopped in order entry, shipping, or both. Both freight amounts are maintained with the delivery. The Freight Bill Type options are:</p> <ul style="list-style-type: none"> • <i>OrderEntry</i>: The freight amount that is passed to PeopleSoft Billing is calculated or entered when the sales order is saved or during the Order Completion process; however, the freight charges are not passed until the order is shipped. The delivery that is automatically created for the entered sales order lines is used to calculate freight. OMBill sends these freight charges to PeopleSoft Billing to be placed on the customer's invoice. When you bill at order entry, you can only recalculate or override freight charges before the first demand line on that delivery ships. If you ship order lines within a delivery multiple times due to backorders or partial shipments, the full freight amount is charged with the first shipment. Using this option, you can initiate freight rating at shipment time; however, the new freight calculation is purely for information and comparison purposes. • <i>Shipping</i>: The freight amount that is passed to PeopleSoft Billing is calculated or entered during the shipping process in PeopleSoft Inventory, including on the Shipping/Issues component, the Delivery Management Workbench, the Shipping Request process page, and any incoming Inventory Freight Response EIP transaction. Freight charges can also be calculated earlier in the fulfillment process. The delivery is used to calculate freight. Because this delivery has passed through most of the demand fulfillment steps, any backordered demand lines have been removed from the delivery or other changes have been made to the delivery before the freight calculation. OMBill sends these freight charges to PeopleSoft Billing to be placed on the customer's invoice. <p>The Freight Bill Type field is located at the customer level on the General Information - Bill To Options page. The Freight Bill Type is supplied by default to the sales order (header level) and then added to the delivery ID containing the sales order. The Freight Bill Type is stored in the IN_DELIVERY table (header level). Once a sales order line is on a delivery, you cannot change the value in the Freight Bill Type field on the sales order.</p>

Field or Control	Description
Freight Usage	<p>Specify the type of freight calculation to be done in combination with the Freight Supplier field in the Carrier ID table. Options are:</p> <ul style="list-style-type: none"> • <i>None</i>: No freight calculation is performed. • <i>Internal</i>: The internal freight calculator within the PeopleSoft application is used to apply freight charges to sales orders. • <i>External</i>: A third-party freight provider calculates and provides the freight charges for sales orders. Manifest information can also be generated by the freight provider. This field value enables the PeopleSoft application to send and receive EIP freight transactions. • <i>Both</i>: Either the PeopleSoft internal freight calculator is used or the third-party freight feature is used depending on the option chosen on the Carrier ID table Freight Supplier field. Therefore, based on the carrier ID on the delivery, either the PeopleSoft internal freight calculator or the third-party freight feature could be used. If no carrier ID is specified on the delivery, then the third-party freight feature is used. <p>The Freight Usage field is located on the Shipping and Returns page within the Order Management business unit definition and on the Setup Fulfillment - Delivery/Freight page. The Order Management business unit definition is used only for quote/order entry and batch order completion processing. The Freight Usage field located at the Inventory business unit level (Setup Fulfillment-Delivery/Freight page) is used only for the delivery management component and all Inventory fulfillment processing including shipping.</p>

Field or Control	Description
<p>Freight Supplier and Carrier ID</p>	<p>The Freight Supplier field is located on the Carrier page (CARRIER_TBL). You can use a different freight solution depending on the carrier ID used on the delivery. Some of your carriers may be calculated with the internal PeopleSoft method while other carriers may use a third-party freight supplier. You can also use the Carrier page to define your individual carriers including name, address, taxpayer ID, and other information.</p> <p>The options for the Freight Supplier field are:</p> <ul style="list-style-type: none"> • <i>External</i>: Select to enable this carrier ID to integrate with a third-party freight provider. If the business unit freight usage is <i>internal</i>, no freight calculation occurs. If the business unit freight usage is <i>external</i> or <i>both</i>, third-party freight calculation occurs. • <i>Internal</i>: Select to enable this carrier ID to use the PeopleSoft internal freight calculator. If the business unit freight usage is <i>external</i>, no freight calculation occurs. If the business unit freight usage is <i>internal</i> or <i>both</i>, internal freight calculation occurs. • <i>(blank)</i>: Select a blank field to prevent freight calculations with this carrier. No freight calculation occurs regardless of the business unit freight usage setting. <p>The carrier ID can be assigned to a delivery by:</p> <ul style="list-style-type: none"> • The system using the carrier from the first order schedule demand line added to the delivery. • The third-party freight provider when it determines the best way to ship the delivery. • The user performing rate-shopping with the third-party freight provider and selecting a carrier. • The user manually assigning a carrier to a delivery. <p>The carrier ID can be defined within the Order Management default hierarchy on the Order Groups page, the customer's General Information - Ship To Options page, and the Buying Agreement Form-Header Terms page. In the default hierarchy, the more specific information overrides the more general information; in this case, a carrier ID defined on a buying agreement overrides a carrier ID on a customer and a carrier ID on the customer would override a carrier ID on the order group. You can manually override the default carrier ID value on the sales order schedule line by using the Ship To Header Details page (order level), the Ship Options 1 tab of the Order Entry Form page (line level), or the Order Entry Form-Shipment Schedule page (schedule level). The carrier ID</p>

Field or Control	Description
	value on the order schedules lines can flow to the delivery ID created.
Freight Terms Code	<p>Determines whether the buyer or the seller pays the freight. Using the Cost/Insurance/Freight Paid By group box, select one of the following options:</p> <ul style="list-style-type: none"> • <i>Buyer</i>: If the buyer pays the freight, freight charges pass to PeopleSoft Billing. The Freight Bill Type field determines when the freight charges are passed to PeopleSoft Billing: at order entry or when the order is depleted from PeopleSoft Inventory. • <i>Seller</i>: If the seller pays the freight, charges do not pass to PeopleSoft Billing. <p>The freight terms code can be defined within the Order Management default hierarchy on the Order Groups page, the customer's General Information - Ship To Options page, and the Buying Agreement Form-Header Terms page. In the default hierarchy, the more specific information overrides the more general information; in this case, a freight terms code defined on a buying agreement overrides a freight terms code on a customer and a freight terms code on the customer would override a freight terms code on the order group. The freight terms code that is supplied by default to the sales order schedule line can be manually overridden using the Ship To Header Details page (order level), the Ship Options 1 tab of the Order Entry Form page (line level), or the Order Entry Form-Shipment Schedule page (schedule level).</p>
Freight Charge Method	<p>Determines how the freight charges are allocated from the delivery-level to the sales orders within the delivery. For more information on this field, see Applying Freight Charges to Deliveries and Orders section of this topic.</p> <p>See Applying Freight Charges to the Order Level.</p>

Field or Control	Description
<p>Use Preferred Freight Carrier</p>	<p>Select <i>Yes</i> to indicate that the customer prefers a particular carrier. The delivery management feature uses this preferred carrier ID for freight calculations. When the delivery is created for demand lines with a preferred carrier, then the system assigns that carrier ID to the delivery or the system finds another delivery with the same carrier ID already assigned to it. The demand line is also flagged as preferred carrier so that other fulfillment steps will know that the customer has requested the carrier for freight.</p> <p>The Use Preferred Freight Carrier field is located on several pages in the Order Management default hierarchy but it must always be used with the Carrier ID field on the same page. For example, to define a preferred carrier on the order group, you would select <i>Yes</i> in the Use Preferred Freight Carrier field and then enter the preferred carrier in the Carrier ID field of the same page. The Use Preferred Freight Carrier field cannot be set to <i>Yes</i> if the Carrier ID field is blank.</p> <p>The Use Preferred Freight Carrier field and the Carrier ID field can be defined within the Order Management default hierarchy on the Order Groups page, the customer's General Information - Ship To Options page, and the Buying Agreement Form-Header Terms page. In the default hierarchy, the more specific information overrides the more general information; in this case, a preferred carrier defined on a buying agreement overrides a preferred carrier on a customer and a preferred carrier on the customer would override a preferred carrier on the order group. The values that are supplied by default to the sales order schedule line can be overridden manually by means of the Ship Options 1 tab and the Ship Options 2 tab of the Order Entry Form page (line level) or the Order Entry Form-Shipment Schedule page (schedule level). The delivery management feature uses this value from the sales order demand line to assign the preferred carrier to the delivery when the delivery is first created. The demand line is also set as preferred carrier to indicate to users downstream in the fulfillment process that the carrier ID has already been selected for the demand and is assigned specifically for freight. If the user sets the Use Preferred Freight Carrier field to <i>Yes</i> after the demand line has been put on a delivery ID and the carrier ID on the delivery is missing, then the system moves the schedule line to a new delivery. If the user manually overrides the carrier on an existing delivery, then the Use Preferred Freight Carrier field is automatically set to <i>Yes</i>.</p>

Field or Control	Description
Ship Via	<p>Use the Ship Via code to define the dimensions of one or more delivery vehicles, such as small delivery truck, large truck, or boxcar. If the ship via code is used as a delivery key on the Inventory Definition - Business Unit Options: Delivery Management page, then the weight and volume constraints defined by the ship via code determine when a delivery has reached capacity and a new delivery ID must be created. For you to use ship via capacity constraints on a delivery, the individual items must contain weight and volume data on the Define Business Unit Item - Inventory: Weight/Volume page or the Define Item - General: Dimensions page. The Define Item - General: Dimensions page is used when the same fields are not defined on the Define Business Unit Item - Inventory: Weight/Volume page.</p> <p>The PeopleSoft automatic delivery management logic in Order Management and Inventory uses the ship-via maximum constraint values for both weight and volume to determine when to automatically assign demand lines to a new delivery. When either the weight or volume maximum constraint is to be violated with the addition of a new demand line, the demand line is assigned to a new delivery. The automatic delivery management logic does not allow a delivery to exceed the maximum ship-via constraints. In order entry, the CSR also receives a warning when the minimum ship-via constraint has not been met.</p> <p>For the third-party freight provider feature, the ship via code is used to define freight services.</p> <p>The ship via code can be defined within the Order Management default hierarchy on the Order Groups page, customer's General Information - Ship To Options page, and the Buying Agreement Form-Header Terms page. In the default hierarchy, the more specific information overrides the more general information; in this case, a ship via code defined on a buying agreement overrides a ship via code on a customer and a ship via code on the customer would override a ship via code on the order group. The ship via code that is supplied by default to the sales order schedule line can be manually overridden by means of the Ship To Header Details page (order level), the Ship Options 1 tab of the Order Entry Form page (line level), or the Order Entry Form-Shipment Schedule page (schedule level).</p>

Field or Control	Description
Process Freight Charges	<p>(Order entry only) Use the Order Entry Features page within the Order Management business unit definition to determine when freight charges should be calculated and applied to a sales order.</p> <p>See "Order Entry Features Page" (PeopleSoft Order Management).</p>
Freight Product ID and Miscellaneous Freight Charges	<p>Freight charges can be passed to PeopleSoft Billing where they are added as bill lines on the customer's invoice. To record freight charges in PeopleSoft Billing, you must:</p> <ul style="list-style-type: none"> • Define a dummy product ID for freight charges. • Enter the dummy product IDs to be used for freight charges on the Accounting and Billing page of the Order Management business unit definition or the Inventory Definition - Business Unit Options: Revenue and Billing Defaults page. <p>In addition, you can define another product ID for miscellaneous freight changes that you can manually enter using the Shipping/Issues component.</p>
BI Unit	<p>On the Order Management Definition - Order Management Setup page, enter the PeopleSoft Billing business unit to be used for invoicing the sales order of this Order Management business unit.</p>
Weight and Volume of Items	<p>Use the Define Business Unit Item - Inventory: Weight/Volume page to define the weight and volume of the item. If no value is entered, then the system uses the item weight and volume on the UOM Weight/Volume page (Items, Define Items and Attributes, Units of Measure, click the UOM Weight/Volume link). If no value is entered on the UOM Weight/Volume page, then the system uses the item weight and volume on the Define Item - General: Dimensions page.</p>
Freight Rollup	<p>Determines which freight charges are picked up and applied to the delivery. For more information on this field, see Applying Freight Charges to Deliveries and Orders section of this topic.</p> <p>See Receiving Freight Charges.</p>

Pages Used to Set Up Basic Information for Freight Charges

Page Name	Definition Name	Usage
"General Information - Bill To Options Page" (PeopleSoft Order to Cash Common Information)	CUST_BILLTO_OPT	Define the Freight Bill Type field for the customer.
Shipping and Returns Page	BUS_UNIT_TBL_OM6	Enter values in the Freight Usage field and the Deliveries Restricted to Order field for the Order Management business unit.
"Setup Fulfillment-Delivery/Freight Page" (PeopleSoft Inventory)	OF_SETUP10_INV	Enter a value in the Freight Usage field for this Inventory business unit. For more information about this page, see "Setting Up Business Unit and Item Options" (PeopleSoft Inventory)
Carrier Page	CARRIER_TBL	Use the Freight Supplier field to define whether freight is calculated by a third-party carrier or internally by the PeopleSoft application.
Order Group Shipping Terms Page	ORD_GROUP_TERMS	(optional) Define carrier ID, freight terms code, the Deliveries Restricted to Order field, and ship via code at the order group level.
"General Information - Ship To Options Page" (PeopleSoft Order to Cash Common Information)	CUST_SHIPTO_OPT1	(optional) Define carrier ID, freight terms code, the Deliveries Restricted to Order field, and ship via code at the customer level.
Buying Agreements - Header Terms Page	SCON_HDR_TRMS	(optional) Define the freight terms code, ship via code, the Deliveries Restricted to Order field, and carrier ID for a buying agreement.
Freight Terms Page	FREIGHT_TERMS	Define freight term codes to be used. The freight term determines whether the buyer or seller pays freight charges. If the seller pays freight charges, then PeopleSoft software does not apply freight charges on the stock requests of this business unit.
Ship Via Codes Page	SHIP_VIA_CD	Define ship via codes.

Page Name	Definition Name	Usage
Order Entry Features Page	BUS_UNIT_TBL_OM9	Select values for the Process Freight Charges row to enable freight calculations for the PeopleSoft Order Management business unit. Use this page to determine when deliveries should be created and when freight should be applied to the delivery.
Product Definition - Definition Page	PROD_DEFN	Define product IDs.
Accounting and Billing Page	BUS_UNIT_TBL_OM5	Enter dummy product IDs for freight charges and miscellaneous freight charges.
Order Management Definition - Order Management Setup Page	BUS_UNIT_TBL_OM1	Use the BI Unit field to link this Order Management business unit to a Billing business unit. You can create invoices by Order Management business unit or by Inventory business unit. If you also link a Billing business unit to an Inventory business unit, the Inventory business unit takes precedence. Order schedules that have been shipped, including nonstock items, are pulled into the Billing system for creation of invoices. The process of invoicing is governed by rules associated with the Billing business unit that you enter on this page. These rules determine billing frequency, billing method, and so on.
Define Business Unit Item - Inventory: Weight/Volume Page	WTVOL_ATTRIB_INV	Define item information for weight and volume at the Inventory business unit level.
UOM Weight/Volume Page	INV_ITEM_WTVOL	Assign stocking and shipping UOMs.
Define Item - General: Dimensions Page	INV_ITEMS_DEFIN3	Define the weight and volume of an item at the SetID level.

Entering Freight Charges Manually

In PeopleSoft Order Management quote and order entry, freight can be entered manually on each delivery assigned to the order. If no delivery is assigned, you can enter the freight amount for the order.

In PeopleSoft Inventory, freight charges can be added manually on several pages and process pages.

Freight can be entered manually on the:

- *Packing Session component* or *Ship Container Detail page*: Per shipping container, you can manually enter a freight amount and container weight. This freight amount override is only applied if the Freight Rollup field has the value of *Rollup* on the delivery. If you pack shipping containers into other shipping containers, the system uses the freight amount of the outermost shipping container only.
- *Shipping/Issues component*: At the shipping ID level, you can launch the PeopleSoft internal or external freight calculator by selecting the *Auto Process* value in the **Freight Option** field and saving the shipment.

At the sales order level, you can use the Freight Information tab of the Order Summary page to; manually enter overrides to the freight amount, add additional freight charges to the existing freight amount, or subtract additional freight charges from the existing freight amount. In addition, the Shipping/Issues component enables you to add miscellaneous charges to the order. If a freight amount override has been entered on the Shipping/Issues component, then the freight override remains unchanged if freight is recalculated.

If delivery processing is activated for the PeopleSoft Inventory business unit and multiple deliveries already exist for the shipment and the order, a sum of the deliveries' existing freight for the ship ID and order is displayed for each order. If the freight amount is changed here when multiple deliveries for the ship ID and order exist, the first delivery is updated with the freight change.

If delivery processing is not activated for the Inventory business unit, the freight that you enter here is passed to PeopleSoft Billing and PeopleSoft Cost Management after the order lines have been depleted and the interface processes are run. If delivery processing is activated for the PeopleSoft Inventory business unit, the *Commit Freight for Billing* status on the delivery dictates when freight amounts are passed to PeopleSoft Billing and Cost Management. If any freight amount for the delivery ID, ship ID, and order has been billed or costed, then you cannot change the freight amount.

- *Front End Shipping Requests process page* or *Shipping Requests process page*: At the transaction request level, these run control pages enable you to override or add a freight amount or select the **Calculate Freight** check box to use the internal or external freight calculator. Freight charges can be added manually in the **Freight Amount** field. Based on the Freight Amount Action field, these manually entries can override the existing freight amount or can be added to the existing freight amount.

If delivery ID is used as part of the selection criteria, the freight amount entered on the run control is assigned at the delivery level and then is prorated to the sales order level for the demand lines assigned to that delivery. If the shipping container ID is used as part of the selection criteria or the shipping container ID is entered as an override value, the freight amount entered on the run control is assigned at the shipping container level. In all other cases, the freight amount entered is prorated across all the demand lines (orders) selected and applied to any assigned deliveries accordingly. Keep in mind that freight charges assigned to the shipping container level will not be billed on the delivery unless the Freight Rollup field has the value of *Rollup*.

- *Inventory Pick Confirm EIP, Inventory Front End Shipping EIP, Inventory Shipping EIP:* or *Fulfillment Workbench*: At the request, group, or detail level you can add a freight amount or select the **Calculate Freight** check box to use the internal or external freight calculator. You can enter freight only at one of these levels for the transaction. Add a value to the **Freight Amount** field, and use the **Freight Amount Action** field to apply your manual freight amount as an override amount or an addition from the calculated freight charge.

You can enter freight only at one of these levels for the transaction.

If delivery ID is used as part of the selection criteria or the delivery ID is entered as an override value, the freight override amount entered is assigned at the delivery level and then the freight amount is prorated to the orders for the demand lines assigned to that delivery. If the shipping container ID is used as part of the selection criteria or the shipping container ID is entered as an override value, the freight override amount entered is assigned at the shipping container level. In all other cases, the freight amount entered is prorated across all the demand lines (orders) selected and applied to any assigned deliveries accordingly.

- *Delivery Management Workbench*: Use the Freight Amount field or the Freight Chrg field to override freight at the delivery, shipping container, or the package level. Be sure to select the Freight Charge Override check box to apply the freight amount as an override.

If you override freight on one order of a multiple-order delivery and then have the third-party freight provider calculate freight, the calculated freight amount is not prorated to the override order. For example, you have one delivery containing two orders (order number 1 and 2). You enter an override freight amount of 10 USD on order number 1 and then send the delivery out to the third-party freight system. The third-party system returns a freight amount for the entire delivery of 100 USD. Assume that without the override, the system would prorate the delivery-level freight amount at 50 percent for each order. However, with the override freight amount of 10 USD on order number 1, the system only applied the prorated freight amount to order number 2. Therefore, order number 1 has the freight amount of 10 USD and order number 2 has the freight amount of 50 USD (half of 100 USD). When the orders are sent to PeopleSoft Billing and PeopleSoft Cost Management, 10 USD and 50 USD are used for costing and billing, totaling 60 USD not 100 USD.

You can also override the pro number or tracking number for the ship transaction. If a delivery ID is used as part of the selection criteria or the delivery ID is entered as an override value, a pro number can be entered as an override value, and the pro number is assigned to the delivery. If the shipping container ID is used as part of the selection criteria or the shipping container ID is entered as an override value, a tracking number can be entered as an override value, and the tracking number is assigned to the shipping container.

Applying Freight Charges to Deliveries and Orders

This section discusses how to:

- Receive freight charges.
- Apply freight changes to the order level.

Receiving Freight Charges

Freight charges can be passed from an external third-party freight system or calculated by the internal PeopleSoft freight calculator. In both cases, the freight charges are stored at the delivery level in PeopleSoft and then allocated to the sales orders within the delivery. In this section, how the freight charges are received and added to the delivery ID is discussed. In addition, how manual overrides at the delivery or order level are applied is also discussed.

The following diagram illustrates the receipt of freight amounts from an external third-party freight system or from the internal PeopleSoft freight calculator:

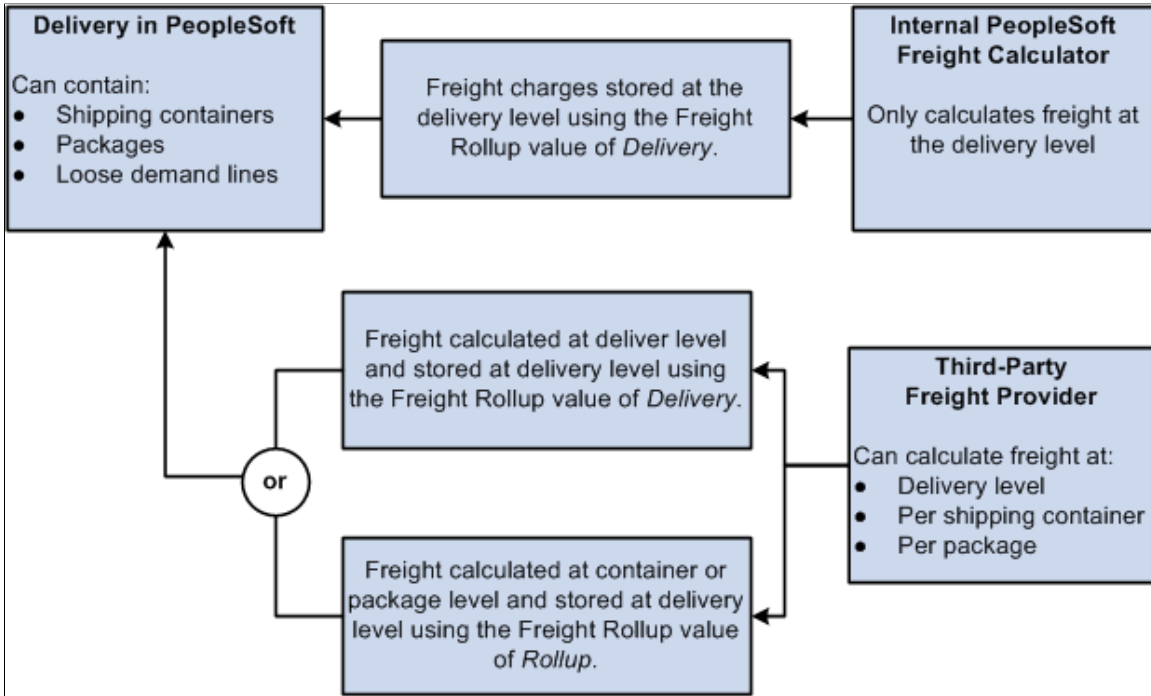

Field or Control	Description
Internal PeopleSoft Freight Calculator	The internal PeopleSoft freight calculator always returns freight at the delivery level.
External Freight System	The external third-party freight systems could return freight at both the delivery level and the package and shipping container level.

Field or Control	Description
Freight Rollup field	<p>The Freight Rollup field determines which freight charges are picked up and applied to the delivery in the Freight Amount field of the IN_DELIVERY_FRT table. The options are:</p> <ul style="list-style-type: none"> • <i>Delivery</i>: (default) The freight amount calculated at the delivery level by the internal or external system should be stored at the delivery-level in PeopleSoft. This amount is used for billing and costing. This option must be used for the internal PeopleSoft freight calculator. • <i>Rollup</i>: (external system only) The freight amounts calculated by the external system at the shipping container and package levels should be summed and stored at the delivery-level in PeopleSoft. This total is used for billing and costing. • <i>Default</i> or blank field: The system uses the Freight Rollup value already defined on the delivery. <p>You can manually set the Freight Rollup field on the Delivery Management Workbench, the Fulfillment Requests process page, or the incoming transaction request using EIPs.</p>
Delivery in PeopleSoft	<p>Based on the value in the Freight Rollup field on the delivery, the freight amount is determined and then stored at the delivery level.</p> <ul style="list-style-type: none"> • If the Freight Rollup field has a value of <i>Delivery</i>, then the delivery-level freight charges returned by the third-party system are stored in the Freight Amount field on the delivery (IN_DELIVERY_FRT) and used for billing and costing. • If the Freight Rollup field has a value of <i>Rollup</i>, then the freight charges returned for the shipping container and packaging levels are totaled and stored in the Freight Amount field on the delivery (IN_DELIVERY_FRT). This rolled up total is used for billing and costing.

When you initiate freight calculation (internal or external) from the PeopleSoft Order Management pages or process pages, the system always uses *Delivery* option for the Freight Rollup field.

For informational purposes, the Freight Audit fields store the freight amounts received from the third-party system regardless of the Freight Rollup field. The Freight Audit fields are not used for billing or costing. The Freight Audit Amount field (FRT_CHRG_AUDIT) on the delivery, on the shipping container, or on the package are used to record any freight amounts coming from the third-party system. These values can be used for reporting or research.

Manual Overrides With the Freight Rollup Field

The following rules apply if you manually override the freight amount on a delivery, order, shipping container, or package:

- A freight amount override at the shipping container or package level is only applied if the Freight Rollup field has the value of *Rollup* on the delivery. If the Freight Rollup field has a value of *Delivery*

then your override amounts at the shipping container or package level are stored in information-only fields; the overrides are not used.

- A freight amount override at the delivery level is always applied regardless of the value in the Freight Rollup field (Rollup or Delivery). The freight amounts returned from the third-party freight provider are stored in the Freight Audit Amount field (FRT_CHRG_AUDIT) on the delivery but the override amount is used for billing and costing.

Applying Freight Charges to the Order Level

Once freight charges have been received and applied to the delivery level (in the Freight Amount field of the IN_DELIVERY_FRT table), PeopleSoft immediately allocates the freight charges to each sales order within the delivery. The allocated amounts are stored in the IN_DELIVERY_ORD table by a combination of delivery ID and sales order number. The IN_DELIVERY_ORD table also stores any overrides at the sales order level and any manually entered miscellaneous shipping charges entered in the Shipping/Issues component in PeopleSoft Inventory. If the freight amount for the delivery is recalculated or changed, the system reallocates the freight to the sales order level.

The Freight Charge Method field on the delivery determines how freight charges are allocated to the sales order. All demand lines on the delivery must have the same freight charge method. The Freight Charge Method is a required delivery key for building a delivery. The Freight Charge Method field has four options:

- *Order Quantity*: Allocate freight charges based on the item quantity within each demand line.
- *Order Value*: Allocate freight charges based on the total price within each demand line. This option is only available when you calculate freight on the quote or sales order using the internal PeopleSoft calculator. Be sure to run the Order Completion (OM_BACKGRND) process to calculate prices before calculating freight.
- *Volume*: Allocate freight charges based on the shipping volume within each demand line.
- *Weight*: Allocate freight charges based on the shipping weight within each demand line. This option is the only option available if you are using the freight amount from the Fulfillment Workbench, the Shipping Requests process page, the Front End Shipping Requests process page, or the shipping EIP transactions.

For sales order entry defaulting, the Freight Charge Method can be defined within the default hierarchy on the Order Groups page, the customer's General Information - Sold To Options page, and the Buying Agreement Form-Header Terms page. In the default hierarchy, the more specific information overrides the more general information; in this case, a freight charge method defined on a buying agreement overrides a freight charge method on a customer and a freight charge method on the customer would override a freight charge method on the order group. The freight charge method value that is supplied by default to the sales order schedule line can be overridden manually by means of the Order Entry Form-Shipment Schedules: Ship Options 2 page. The freight charge method value on the order schedules lines flows to the delivery ID created for the lines.

Example of Freight Charge Allocation from the Delivery Level to the Sales Order Level

This example reviews the application of freight charges to the sales order level.

The following diagram illustrates the process flow for creating a delivery, calculating the freight charge at the delivery level, and prorating the freight charge to the sales order level.

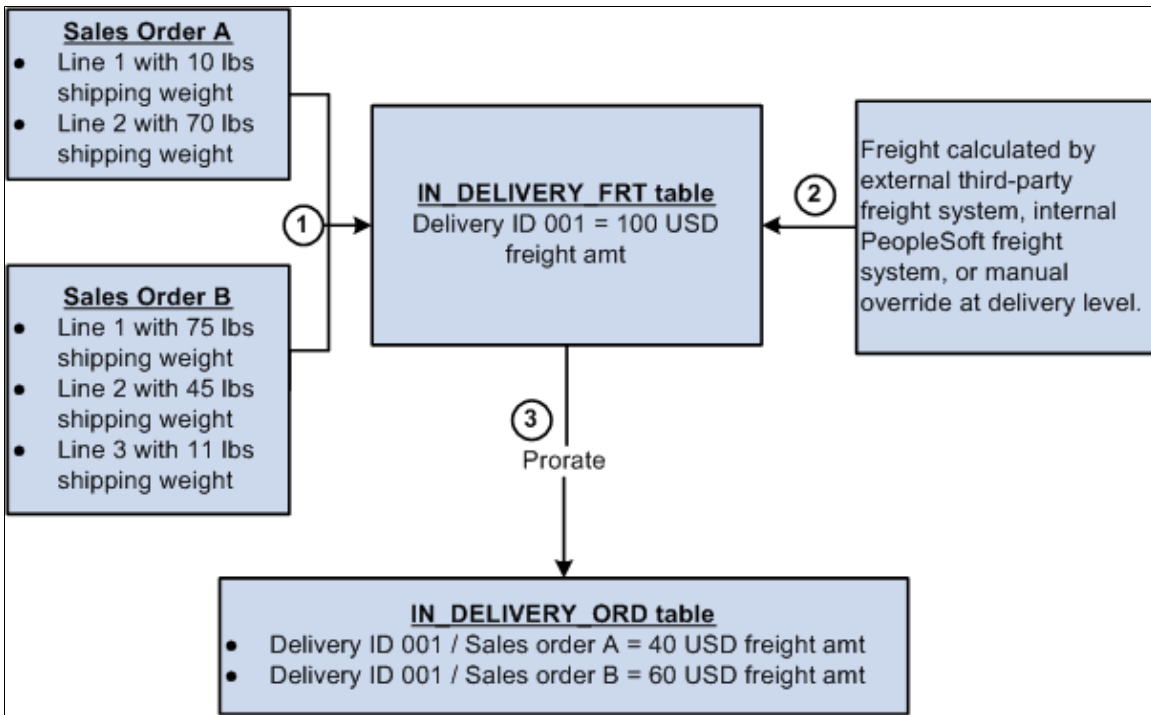

The freight charge is prorated to the sales order as follows:

1. Sales order A and sales order B are entered into the system. The Order Completion process runs in the background and assigns lines 1 and 2 of each sales order to delivery ID 001. The third line of sales order B is to be shipped from another warehouse (different PeopleSoft Inventory business unit) and cannot be on the same delivery as the rest of the order.
2. Freight is calculated for delivery ID 001. Freight can come from the external freight system, the internal PeopleSoft freight calculator, or be an override value that was manually entered. The freight charge of 100.00 USD is stored in the IN_DELIVERY_FRT table.
3. The freight charge is prorated to the sales order level using the option of *Weight* in the Freight Charge Method field. The shipping weight for each demand line within the delivery is totaled. The combined shipping weight is 200 pounds as follows:

Sales Order	Line Number, Schedule Line, Demand Line	Shipping Weight
A	1/1/1	10 LBS
A	2/1/1	70 LBS
B	1/1/1	75 LBS
B	2/1/1	45 LBS

The shipping weight for sales order A is 80 LBS (10 + 70) and the shipping weight for sales order B is 120 LBS (75 + 45). The freight charge of 100 USD is prorated as 40% to sales order A (80 / 200) and 60% to sales order B (120 / 200).

In the IN_DELIVERY_ORD table, 40 USD (40% of 100) is recorded for delivery ID 001 and sales order A. 60 USD (60% of 100) is recorded for delivery ID 001 and sales order B.

Manual Overrides and Prorating Freight Charges to the Sales Order

Freight charges can be manually overridden at the delivery or sales order level. When allocating the freight charge to the sales order level, the following rules apply:

- An override at the delivery level is prorated to the sales order level using the Freight Charge Method field on the delivery. This process is the same as if the freight charge was calculated by the internal or external freight systems.
- An override at the sales order level remains the same. Freight can still be calculated at the delivery-level and any remaining sales orders within the same delivery are assigned their prorated share of the delivery-level freight amount. In this case, the delivery-level freight amount and the sum of the order-level freight amounts will not equal.

For example, you have one delivery containing two orders (order number 1 and 2). You enter an override freight amount of 10 USD on order number 1 and then send the delivery out to the third-party freight system. The third-party system returns a freight amount for the entire delivery of 100 USD. Assume that without the override, the system would prorate the delivery-level freight amount at 50 percent for each order. However, with the override freight amount of 10 USD on order number 1, the system only applied the prorated freight amount to order number 2. Therefore, order number 1 has the freight amount of 10 USD and order number 2 has the freight amount of 50 USD (half of 100 USD). When the orders are sent to PeopleSoft Billing and PeopleSoft Cost Management, 10 USD and 50 USD are used for costing and billing, totaling 60 USD not 100 USD.

- On many pages, if freight has already been calculated, then the Freight Amount field can be used to apply an increase or decrease to the freight charge, instead of an override. The system calculates freight charges at the delivery-level, prorates the amount to the sales order level, and then the manual entry in the Freight Amount field is added or subtracted from the sales order freight charge.

Committing Freight Charges to PeopleSoft Billing and Cost Management

Once the freight amounts have been calculated and applied to the order level, the freight and miscellaneous charges must be passed to the PeopleSoft Billing and PeopleSoft Order Management applications. On the delivery, the Commit Freight for Billing check box controls when the information can be sent. When the Commit Freight for Billing field has the value of Y (yes), then:

- The Populate Billing process (OMBILL) in PeopleSoft Order Management can pass the freight amounts to PeopleSoft Billing to be placed on customer invoices.
- Once the order is depleted, then the freight amounts are available to PeopleSoft Cost Management to be recorded as shipping costs.

The Commit Freight for Billing field enables you to control when the freight charges are billed and costed without delaying the running of the above processes.

The same amounts are passed to both PeopleSoft Billing and PeopleSoft Cost Management. When the demand lines of the delivery are in the shipped state or any prior state, freight can be manually entered, calculated using the third-party freight provider or calculated using the internal PeopleSoft freight calculator. Once the demand lines are in the depleted state, you can manually override freight charges but you cannot use the internal or external freight systems to calculate freight. No freight can be applied to a line on the delivery that has been billed or costed.

You can select the Commit Freight for Billing check box (this sets the value to yes) on several online pages and process pages, including the:

- Delivery Management Workbench.
- Freight Management page and Freight Results page.
- Shipping/Issues component.
- Shipping Requests process page.
- Front End Shipping Requests process page.
- Fulfillment Workbench.
- Picking Confirmation process page.
- Material Picking Feedback component.
- Process Deliveries/Freight process page.
- Fulfillment Requests process page.
- Inventory Pick Confirm EIP, Inventory Front End Shipping EIP, and Inventory Shipping EIP,

In order to set the Commit Freight for Billing field to the value of yes, the above online pages and processes must be moving the demand lines of the delivery into the shipped fulfillment state or the demand lines must already be in the shipped state.

The following points are important when working with the Commit Freight for Billing field:

- The Freight Bill Type field on the delivery determines which freight charge is sent to PeopleSoft Billing and PeopleSoft Cost Management. If the Freight Bill Type field has the value of *OrderEntry* then the system passes the freight charges calculated or entered when the sales order is saved or during the Order Completion process in PeopleSoft Order Management. If the Freight Bill Type field has the value of *Shipping* then the system passes the freight charges and miscellaneous charges calculated or entered during the fulfillment steps in PeopleSoft Inventory.
- The Delivery Option field on the Setup Fulfillment-Delivery/Freight page determines how the Commit Freight for Billing field is used. If the Delivery Option field has the value of *No* then the system does not use the Commit Freight for Billing field; once the lines are in the deleted fulfillment state, the manually-entered freight charges can be passed whenever you run the Populate Billing process (for PeopleSoft Billing) and the Cost Accounting Creation process (for PeopleSoft Cost Management). If the Delivery Option field has the value of *Manual* or *Yes* then the Commit Freight for Billing field is used and must be set to yes before freight and miscellaneous charges on a depleted

line can be billed or costed. If using the manual option you can ship and deplete orders without creating deliveries; these orders can be billed and costed after running the Deplete On Hand Qtys process. The system recognizes that a delivery is not required in this situation.

Using PeopleSoft Tables to Store Delivery and Freight Information

This section discusses the table structure and fields used to create and store deliveries and freight data. This section applies to delivery management, the internal PeopleSoft freight calculator, the external third-party freight integration, and the manual entry of freight costs.

Delivery information can be stored at three levels:

- *Delivery level*
- *Container level*
- *Package level*

Delivery and freight information is contained in the following PeopleSoft tables:

Field or Control	Description
IN_DELIVERY	This is the parent level for delivery information. All information is stored at the delivery level, that is, by delivery ID. Freight status, freight amounts, and a pro number can be defined at the delivery level.
IN_DELIVERY_FRT	This is a child table to the IN_DELIVERY table and stores the freight amount applied at order entry time in PeopleSoft Order Management and the freight amount applied during demand fulfillment in PeopleSoft Inventory. The Freight Bill Type field determines which of these freight amounts is used for billing or costing.
IN_DELIVERY_PKG, IN_DEL_PKG_FRT, IN_DEL_PKG_RPT	This is a child level to the IN_DELIVERY table and stores package level weight and volume information. Multiple packages per delivery can exist. Although freight amounts and tracking numbers can be defined and stored at the package level, the freight calculation and manifesting can be done only for an entire delivery. When the EIP sends and receives transactional data with a third-party freight provider, all packages, shipping containers, and demand lines within one delivery are freighted and manifested in the same transaction; you cannot freight and manifest just one part of a delivery.

Field or Control	Description
IN_DELIVERY_ORD	This is a child table to the IN_DELIVERY table and stores the freight amounts to be sent to PeopleSoft Billing for the customer's invoice. These amounts are prorated by sales order demand line based on the delivery freight charge method. Any additional freight charges or miscellaneous charges entered in shipping issues are also stored in this table. The Populate Billing process (OMBILL) updates IN_DELIVERY_ORD. BILLING_STATUS to note that the freight amount has been processed. The freight amount in this table is also passed to PeopleSoft Cost Management.
CM_CST_NSSHIP	Rows are inserted into this table when the Commit Freight for Billing field is set to <i>yes</i> . The costing process picks up all rows with a post status of Not Posted. After the charges are costed, the post status is set to Posted. On a delivery, if the Commit Freight for Billing field is set to <i>yes</i> prior to the delivery being depleted, then the posted status is set to Don't Post. In this case, the Deplete On Hand Qtys process sets the post status to Not Posted when the delivery is depleted.

Note: When applying manual freight to an order that is not assigned to a delivery, a *bill only* delivery is automatically created by the system. This delivery is not exposed to the user and is used internally by the system to maintain consistency in how freight is passed to the billing and costing processes.

The Delivery_ID field is included in IN_DEMAND (the PeopleSoft Inventory demand fulfillment table) and additional freight fields are in SHIP_CNTR_HDR (the PeopleSoft Inventory shipping container header table).

The IN_DELIVERY Table

The status of a delivery is stored in the IN_DELIVERY table. Statuses are:

Field or Control	Description
Demand Pending	This status is used by PeopleSoft Order Management. These deliveries are awaiting demand line assignment. This delivery status is not available in the Delivery Management Workbench or other delivery processing in PeopleSoft Inventory.
Pending for quote	The delivery was created for freight on a quote. This delivery type is available only for quotes in PeopleSoft Order Management. These deliveries are not available for sales order demand assignment or consolidation.
Open	The delivery is open and available for additions from the sales order, the Delivery Management workbench, shipping, or other fulfillment processing.

Field or Control	Description
Closed for Shipment	The delivery is closed and ready for shipment. The system does not automatically add or remove lines from a delivery.
Complete Delivery	All fulfillment steps for the delivery are complete, and all demand lines in the delivery are ready to be depleted using the Deplete On Hand Qtys process.
Canceled	This status is automatically set if all lines are removed from the delivery.

The IN_DELIVERY table includes several fields related to the creation of a delivery and to freight processing, including:

Field or Control	Description
Error Status for Delivery	This Y/N (yes/no) field indicates whether the delivery has an error.
Error Status for Freight	This Y/N (yes/no) field indicates that an error occurred during the freight process.
Freight Status	Determines the current state of the freight process. The options are: <ul style="list-style-type: none"> • <i>Rate Requested:</i> A freight rate request has been sent to the third-party freight provider system. • <i>Rate Received:</i> The third-party freight provider has responded to the freight request and the delivery has been updated.
Manifest Status	Determines the current state of the manifest process. The options are: <ul style="list-style-type: none"> • <i>Manifest Requested:</i> A shipment request for rates and manifesting has been sent to the third-party freight provider system. • <i>Manifest Received:</i> The response to the manifest action was received from the third-party freight provider system.
Commit Freight for Billing	This Y/N (yes/no) field indicates whether the freight on this delivery is ready to be processed by PeopleSoft Billing and PeopleSoft Cost Management.

The IN_DELIVERY_FRT Table

The IN_DELIVERY_FRT table includes:

Field or Control	Description
Freight Amount	The delivery level freight amount (FREIGHT_CHARGE field) returned by the third-party provider, manually entered, or calculated by the PeopleSoft internal freight calculator. Depending on the delivery rollup indicator or the rollup indicator used when processing freight, this may also be the freight amount derived from the sum of the lower-level package and container freight amounts.
Freight Audit	The Freight Audit field (FRT_CHRG_AUDIT) within the IN_DELIVERY_FRT table stores the delivery-level freight amount received from the third-party system. The Freight Audit fields are not used for billing or costing. These values can be used for reporting or research.
Pro Number	A tracking number assigned to the delivery level. This value is returned by the third-party provider or can be manually assigned.
Communicated Arrival Date	The arrival date communicated by the third-party provider for the carrier. This is for information only.
Communicated Ship Date	The ship date communicated by the third-party provider for the carrier. This is for information only.
Freight Reference Number	This is a free-form memo field that can be used by your third-party freight provider.
Freight Service Definition	The code used by the third-party freight provider to define the specific carrier freight service. This service definition may be required depending on the third-party provider.
Freight Type Code	Used to identify the generally accepted types of freight services used with a third-party freight system (parcel, LTL, and so on).
Freight Roll-up Indicator	The roll-up indicator can be manually assigned at delivery to define how the incoming third-party delivery level freight amount should be assigned (delivery freight amount, or the sum of the package and container freight amounts).

The Package Tables

The IN_DELIVERY_PKG is a child table of IN_DELIVERY and contains the individual package information for each package assigned to the delivery. Packages can be created manually in the Delivery Management Workbench or can be returned by the third-party freight system. Related to IN_DELIVERY_PKG is the IN_DEL_PKG_FRT table, which contains package-level freight fields that include:

Field or Control	Description
Freight Amount	The package-level freight amount can be returned by the third-party freight provider or manually entered in the Delivery Management Workbench in PeopleSoft Inventory.
Freight Audit	The Freight Audit field (FRT_CHRG_AUDIT) within the IN_DELIVERY_PKG table stores the package-level freight amount received from the third-party system. The Freight Audit fields are not used for billing or costing. These values can be used for reporting or research.
Tracking Number	The tracking number can be returned by the third-party freight provider or entered manually in the Delivery Management Workbench in PeopleSoft Inventory.
Freight Reference Number	This is a free-form memo field that can be used by your third-party freight provider.
IN_DEL_PKG_RPT.URL	For a package, this field contains a URL pointing to a label file when a report type of 1 (label) is used. This URL is updated from a manifest response.

The Shipping Container Tables

The SHIP_CNTR_HDR table is used by PeopleSoft Inventory for shipping container processing. In PeopleSoft Inventory, you can assign individual demand lines to a shipping container using the Packing Session component. When you are integrating with a third-party freight provider, the SHIP_CNTR_HDR table is used to store shipping container level freight amount and tracking numbers.

Field or Control	Description
Freight Amount	Shipping container level freight amount can be returned by the third-party freight provider or entered manually in the Ship Container Detail page.

Field or Control	Description
Freight Audit	The Freight Audit field (FRT_CHRG_AUDIT) within the SHIP_CNTR_HDR table stores the container-level freight amount received from the third-party system. The Freight Audit fields are not used for billing or costing. These values can be used for reporting or research.
Tracking Number	The tracking number can be returned by the third-party freight provider or entered manually in the Ship Container Detail page.
Freight Reference Number	This is a free-form memo field that can be used by your third-party freight provider.
SHIP_CNTR_RPT.URL	For a shipping container, this field contains a URL pointing to a label file when a report type of 1 (label) is used. This URL is updated from a manifest response.

Chapter 3

Defining External Third-Party Freight Integration

Understanding External Third-Party Freight Integration

Freight can be added to a sales order demand line by:

- Using the PeopleSoft internal calculator within PeopleSoft Order Management or PeopleSoft Inventory.
- Entering freight amounts manually on the sales order at order entry, at shipping time, or on the delivery in the Delivery Management Workbench.
- Receiving freight charges from an external third-party freight provider.

This topic discusses the third-party freight integration setup and processing.

The delivery management feature must be implemented for you to use external third-party freight integration. The delivery structure is the mechanism that you use to transfer to and from the third-party freight provider.

See [Setting Up Delivery Management](#).

When integrating with a third-party freight provider, the PeopleSoft system exchanges information with the freight provider by using enterprise integration points (EIPs). These are service operations that send and receive data messages using the PeopleSoft Integration Broker. In addition to providing freight charges to the delivery, the external freight provider can also provide the following services:

- Printing shipping labels. A link to the shipping labels stored at the third-party provider site is maintained with the delivery, packages, and shipping containers.
- Generating tracking numbers. The tracking numbers are sent to the PeopleSoft system and maintained with the delivery, packages, and shipping containers.
- Printing specialized shipping documents such as bill of lading and export documentations.
- Creating and maintaining shipping manifests for individual carriers.

Note: Whether the preceding services are provided by the third-party freight system depends on your agreement with the external freight provider. Oracle is not responsible for the specific services delivered by the third-party freight provider.

The Building Blocks of External Third-Party Freight

PeopleSoft applications provide several options for sending and receiving freight data from an external third-party system. To implement this PeopleSoft feature, you need to understand:

- Freight request methods.
- Points for providing freight charges, shipping labels, and tracking numbers.
- Asynchronous -versus- synchronous transaction requests.

Freight Request Methods

The PeopleSoft external freight feature provides the following methods to request freight:

- *Rate Shopping*: Rate shopping is an optional feature that enables a user to preview and choose which freight carrier and charges to use on the delivery based on the choices retrieved from the third-party freight provider. This method displays the Freight Rate Shopping page for users to view, evaluate, and select the best freight carrier for their needs. Rate shopping can be performed from the Order Entry Form and from the Delivery Management Workbench. At shipping time, you can easily link to the Delivery Management Workbench from the Shipping/Issues component.
- *Specified Carrier*: The PeopleSoft system sends a request with a specific carrier ID to the third-party provider system, and the third-party provider returns only freight choices from the specified carrier. The user can preview these choices.
- *Best Way*: The PeopleSoft system sends a best way request to the third-party provider system, and the third-party provider returns only one freight choice per delivery ID. The user can preview this choice. The best way options are:
 - *Least Cost*: The third-party freight system selects and returns the freight service with the least cost.
 - *By Commit Date*: The third-party freight system selects and returns the freight service that best matches the scheduled ship date based on the fastest freight service.

Points for Providing Freight Charges, Shipping Labels, and Tracking Numbers

Freight charges, shipping labels, and tracking numbers can be received into the PeopleSoft system at different points in the order fulfillment cycle:

- At order entry or quote entry time for sales orders or quotes. Depending on your setup, freight charges can be received from the third-party provider and applied to a sales order from requests initiated by; the Order Completion process (OM_BACKGRND), the Process Deliveries/Freight process within the Order Management menu, or during online sales order or quote entry. Using the Order Entry Form component in PeopleSoft Order Management, the request for third-party freight charges can be initiated when the user clicks the **Freight Charges** button or when the user saves the order. Shipping labels and tracking numbers are not available at this point in the order fulfillment cycle, because the order is not ready to ship.

If you have selected the *OrderEntry* option for the **Freight Bill Type** field, then these are the freight charges that are sent to PeopleSoft Billing to be placed on the customer's invoice. The order entry freight is managed from Order Entry Form or the Order Completion process. Freight can be calculated in inventory fulfillment, but that freight amount is not billed. When you bill at order entry, you can only recalculate or override freight charges on the sales order before the first demand line ships. If you ship sales order lines within the same delivery multiple times due to backorders or partial shipments, the full freight amount is charged with the first shipment for that delivery. Using this option, you can

initiate freight rating at shipment time; however, the new freight calculation is purely for information and comparison purposes.

- At optional points in PeopleSoft Inventory fulfillment before shipping. Depending on your setup, freight charges can be received from the third-party provider and applied to the delivery and its orders prior to shipment using the Delivery Management Workbench or the Process Deliveries/Freight process within the Inventory menu. Shipping labels and tracking numbers are not available at this point in the order fulfillment cycle, because the order is not ready to ship.
- At shipping time. Depending on your setup, you can receive freight charges from the third-party provider and apply them to the delivery and its orders by sending the synchronous Inventory Freight Ship Request EIP from the Delivery Management Workbench or from the Shipping/Issues component. This transaction will perform a manifest action allowing you to manifest the shipment in the third-party freight system and return freight rates, carrier assignments, tracking numbers, and label URL references to the PeopleSoft system. You also have the option to send the asynchronous Inventory Freight Rate Request EIP to manifest a delivery when deliveries are shipped using the batch shipping process or by selecting the manifest option on the Process Deliveries/Freight process within the Inventory menu. In either of these situations, the Inventory Freight Rate Response is returned from the third-party system to update the freight rates, tracking numbers, and label URL references in the PeopleSoft system. All of the demand lines within the deliveries must be in the shipped fulfillment state to receive tracking numbers and shipping label information from the third-party system. Based on your setup, shipping documents can be generated in the third-party system upon manifesting but these documents are not returned to the PeopleSoft system.

Asynchronous - versus - Synchronous Transaction Requests

The PeopleSoft system communicates with the external third-party freight system by sending and receiving transaction requests through the PeopleSoft Integration Broker. The service operations used by the Integration Broker provide two methods of communication:

- *Synchronous*: A synchronous transaction is a transaction request that is sent to a destination where the sender waits for an immediate response before continuing. This is considered a two-way transaction, because the initial request is sent and a response is accepted in the same session. For example, the rate request transaction sent from the Order Entry Form component during freight rate shopping is requesting freight charges to be displayed to the user online. This service operation is synchronous. The availability of the synchronous freight transaction depends on your third-party freight provider.
- *Asynchronous*: An asynchronous transaction is a transaction request that is sent to a destination where the sender is not expecting or waiting for an immediate response. This is considered a one-way transaction, because a response is not returned in the same session. For example, the rate request for third-party freight sent from the Order Completion process in PeopleSoft Order Management does not require an immediate response because no user is waiting for a response. Asynchronous service operations are useful for recording freight charges for a large number of orders or with lights-out processing, such as with EDI sales orders that have been uploaded to PeopleSoft Order Management and now require background processing, including freight charges. The availability of the asynchronous freight transaction depends on your third-party freight provider.

Examples of Third-Party Freight

This section gives several examples of ways to use the external third-party freight feature in PeopleSoft applications. Depending on the needs of your organization, you can implement one or more methods.

Use the information in the Setting Up Third-Party Freight Charges section of this topic to configure your system.

Example 1: Interactive Rate Shopping at Order Entry Time

A user, such as a customer service representative (CSR) can enter a sales order in PeopleSoft Order Management and then shop for freight rates from the external third-party freight system while working with the customer to select the most desired method and cost of shipping. The third-party system responds immediately showing the CSR the freight carriers, amounts, and dates. PeopleSoft Order Entry then allows the CSR to choose one and assign the carrier and freight amounts to the deliveries on the sales order.

Note: This example assumes that the PeopleSoft system and the third-party freight provider have been properly set up to accomplish this method of freight calculation.

The following diagram illustrates the business process flow of a rate shopping integration using the PeopleSoft external third-party freight feature.

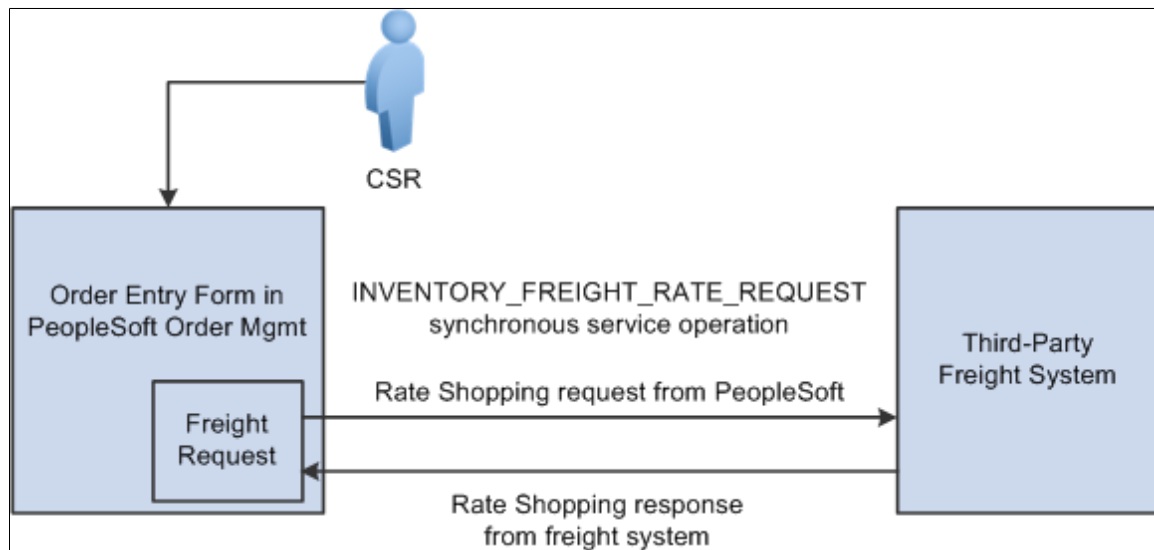

1. The CSR answers the phone and takes the customer's order. The sales order is entered directly into the Order Entry Form component while the customer is on the phone. The CSR saves the component and one or more delivery IDs are automatically created based on the delivery key configuration for the ship-from business unit on the sales order schedules.
2. The CSR requests rate shopping on the Order Entry Form component. The freight request page is displayed, where the CSR can choose the option to shop for rates and preview the freight options available. The Integration Broker uses a synchronous service operation to send out the deliveries to the third-party freight provider. The deliveries created for the sales order are sent out on the freight request transaction.
3. The third-party freight provider responds to the transaction request by returning one or more options for carrier, freight charges, and delivery times.
4. The Freight Rate Shopping page appears for the CSR to view, evaluate, and select the freight option that meets the customer's needs. The CSR is presented with freight options for each delivery assigned to the sales order.

- The CSR communicates these freight options to the customer, and they both agree on an option. The CSR selects the option, and the carrier and freight amounts are updated on each delivery for the sales order. The appropriate carrier is assigned to the demand lines and the sales order schedule lines, and the communicated ship date from the third-party response is used to set the scheduled ship date on the demand and the order schedules.

Depending on the setting of the **Restricted to Order** check box for the delivery and depending on the delivery key configuration for the ship-from business unit on the sales order schedules, the sales order demand might be able to be assigned to deliveries that already exist in the system for other sales orders. In addition, the CSR or warehouse personnel could use the Delivery Management Workbench to combine multiple orders into one delivery ID and then initiate rate shopping from the workbench.

Example 2: Best Way at Order Entry Time

A user, such as a CSR, can enter a sales order in PeopleSoft Order Management and then request freight charges from the external third-party freight system. The third-party system responds immediately giving the CSR the freight charges.

Note: This example assumes that the PeopleSoft system and the third-party freight provider have been properly set up to accomplish this method of freight calculation.

The following diagram illustrates the business process flow of a best way integration using the PeopleSoft external third-party freight feature.



- The CSR answers the phone and takes the customer's order. The sales order is entered directly into the Order Entry Form component while the customer is on the phone. The CSR saves the component and one or more delivery IDs are automatically created based on the delivery key configuration for the ship-from business unit on the sales order schedules.
- The CSR requests freight charges on the Order Entry Form component. The freight request page appears, where the CSR can choose the best-way option to allow the system to find the best freight and assign it to the deliveries for the order. The request is sent to the third-party freight provider by means of the PeopleSoft Integration Broker. The Integration Broker uses a synchronous service operation to send out the deliveries to the third-party freight provider. In this example, least cost was selected as the best way option at the business unit level. The deliveries created for the sales order are sent out on the freight request transaction.

3. The third-party freight provider responds to the transaction request and returns only one freight choice per delivery ID based on least cost to the customer.
4. The CSR can optionally view the delivery IDs and the assigned carrier, scheduled ship date, and freight amount for the sales order.
5. When the freight choices are assigned to the deliveries, the appropriate carrier is assigned to the sales order demand and schedule line and the communicated ship date from the third-party response is used to set the scheduled ship date on the demand and sales order schedules associated with the deliveries.

Example 3: Specific Carrier at Order Entry Time

A user, such as a CSR, can enter a sales order in PeopleSoft Order Management and then request freight charges from the external third-party freight system. The third-party system responds immediately giving the CSR the freight charges.

Note: This example assumes that the PeopleSoft system and the third-party freight provider have been properly set up to accomplish this method of freight calculation.

The following diagram illustrates the business process flow of a specified carrier integration using the PeopleSoft external third-party freight feature.

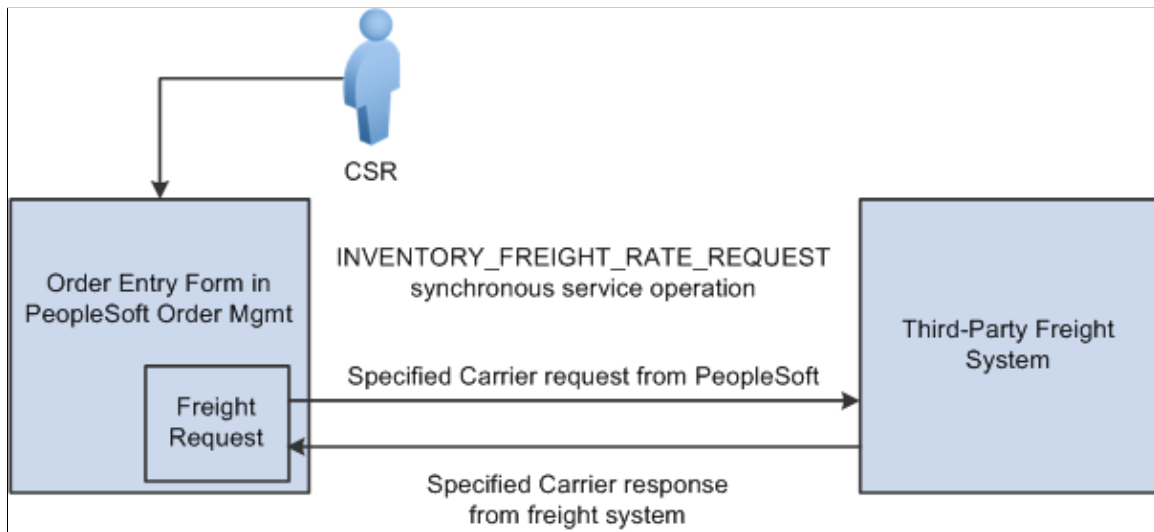

1. The CSR answers the phone and takes the customer's order. The sales order is entered directly into the Order Entry Form component while the customer is on the phone. The preferred carrier check box and carrier ID are provided by default to the sales order based on the Order Management default hierarchy (Order Groups page, the customer's General Information - Ship To Options page, and the Buying Agreement Form-Header Terms page). The CSR saves the component and one or more delivery IDs are automatically created with the specific carrier ID assigned to the deliveries. The demand lines are also saved with the *preferred carrier* flag set to *yes* to indicate to users downstream in the fulfillment process that the carrier ID on the demand and the assigned deliveries has been explicitly assigned.
2. The CSR requests freight charges on the Order Entry Form component. The freight request page appears, where the CSR can select the *Use Specified Carrier* option to request freight only for that carrier. The CSR can then select *Preview Freight* to first review the single freight option or *Process Freight with Post-Ship Actions* to assign the single freight option. The request is sent to the third-party freight provider by means of the PeopleSoft Integration Broker. The Integration Broker uses

a synchronous service operation to send out the deliveries to the third-party freight provider. The deliveries created for the sales order are sent out on the freight request transaction

3. The third-party freight provider responds to the transaction request and returns only one freight choice per delivery ID based on the carrier specified for the delivery.
4. The CSR can optionally view the delivery IDs and the assigned carrier, scheduled ship date, and freight amount for the sales order. The CSR can elect to search from freight again using expanded search options to include other shipping methods and other carriers.
5. When the freight choices are assigned to the deliveries, the appropriate carrier is assigned to the sales order demand and schedule line and the communicated ship date from the third-party response is used to set the scheduled ship date on the demand and sales order schedules associated with the deliveries.

Note: In examples 1 through 3, another alternative is to perform freight rate shopping from the Delivery Management Workbench in PeopleSoft Inventory rather than the Order Entry Form in PeopleSoft Order Management. By using the Delivery Management Workbench, you can perform the same interactive freight request methods (rate shopping, best way, or specific carrier). The workbench enables you to perform carrier assignments and get estimated freight amounts at any time before shipping. The main difference between using the Order Entry Form and the Delivery Management Workbench is that the Order Entry Form stores the freight amount within the Order Management freight amount field whereas the workbench stores the freight amount within the Inventory freight amount field. If your setup uses the value of *OrderEntry* for the Freight Bill Type field, then the Order Entry Form must be used to correctly record the freight amount within the Order Management freight amount field.

Example 4: Batch Assignment of Freight Charges on Incoming EDI Sales Orders

A customer sends sales orders using electronic data interchange (EDI). The sales orders are picked up and processed by the Order Completion process. Deliveries are created. Carrier assignments and estimated freight charges are assigned automatically and saved with the order.

Note: This example assumes that the PeopleSoft system and the third-party freight provider have been properly set up to accomplish this method of freight calculation.

The following diagram illustrates the business process flow of freight charges for a batch of EDI sales orders using the PeopleSoft external third-party freight feature.

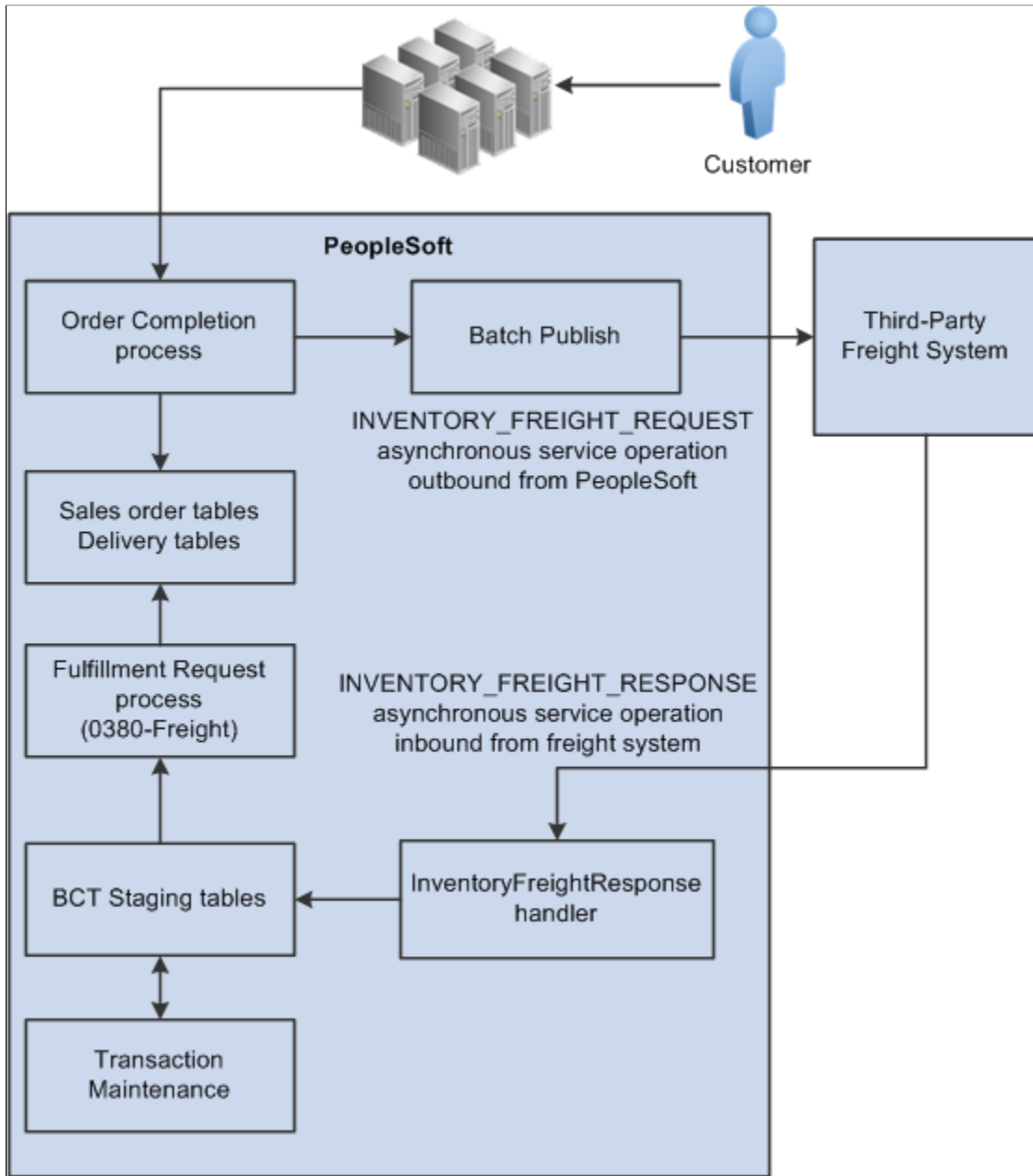

1. The customer sends sales orders using EDI.
2. Your EDI coordinator has defined the run control that picks up the sales orders and processes them through the Order Completion process. The process completes several steps. The freight-specific steps include:
 - Assembling the sales order lines into deliveries. The delivery structure that goes out on the freight request transaction is also stored in the PeopleSoft system.
 - An asynchronous message (INVENTORY_FREIGHT_REQUEST) is sent out to the third-party freight provider. The asynchronous method allows the Order Completion system to complete processing without waiting for the reply from the third-party freight system.

- The Freight Status field on the IN_DELIVERY table is changed to *Rate Requested* for the impacted delivery IDs. This status prevents further processing on the deliveries until a response is received from the external third-party freight system and freight charges are applied to the deliveries and the order.
3. The Batch Publisher process publishes the deliveries from the Order Completion process.
 4. Later, the third-party freight system sends an asynchronous rate-results transaction that provides the resulting freight charges for the delivery IDs associated with the sales order lines.
 5. The PeopleSoft Integration Broker receives the inbound XML message into the INVENTORY_FREIGHT_RESPONSE queue. The InventoryFreightResponse handler, a PeopleTools application class, formats the incoming data and populates the BCT staging tables. For each transaction request, the InventoryFreightResponse handler assigns a unique ID called the EIP_CTL_ID.
 6. The Fulfillment Requests process (IN_FUL_BCT) using the 0380 transaction code (Freight) retrieves the transaction requests from the staging tables, processes them, and applies them to the PeopleSoft production tables. The deliveries for the sales orders are updated with the appropriate carrier and freight charges. Once the rate-results transaction has been processed in the PeopleSoft system, the Freight Status field on the IN_DELIVERY table is changed to *Rate Received* for the impacted delivery IDs.
 7. If the transaction requests are not processed successfully, they are given an error status, and the appropriate error message is provided. The Maintain Transactions component enables you to view and correct requests that contain errors. Once corrected, you can relaunch the Fulfillment Requests process. This is an optional step, you can choose to have the request errors canceled automatically, and then you could create another request.
 8. The sales orders continue through the order fulfillment process.

Example 5: Interactive Freight Calculation at Shipping Time

A user, such as a CSR, can enter a sales order in PeopleSoft Order Management. When the order is saved, the demand for the order lines is added to new or existing delivery IDs. The user can calculate order entry freight as described in the example above. Estimated order entry freight is maintained independently of the estimated shipping freight amount. The sales order is processed through Inventory order fulfillment, which could include removing backordered lines from the delivery ID and other changes in shipping fields. At the shipping stage, the transaction request for freight charges is sent to the external third-party freight system. The third-party system responds with the freight charges, and the freight amounts are applied to the deliveries and their associated sales orders.

Note: This example assumes that the PeopleSoft system and the third-party freight provider have been properly set up to accomplish this method of freight calculation.

The following diagram illustrates the business process flow of interactive freight calculation at shipping time.

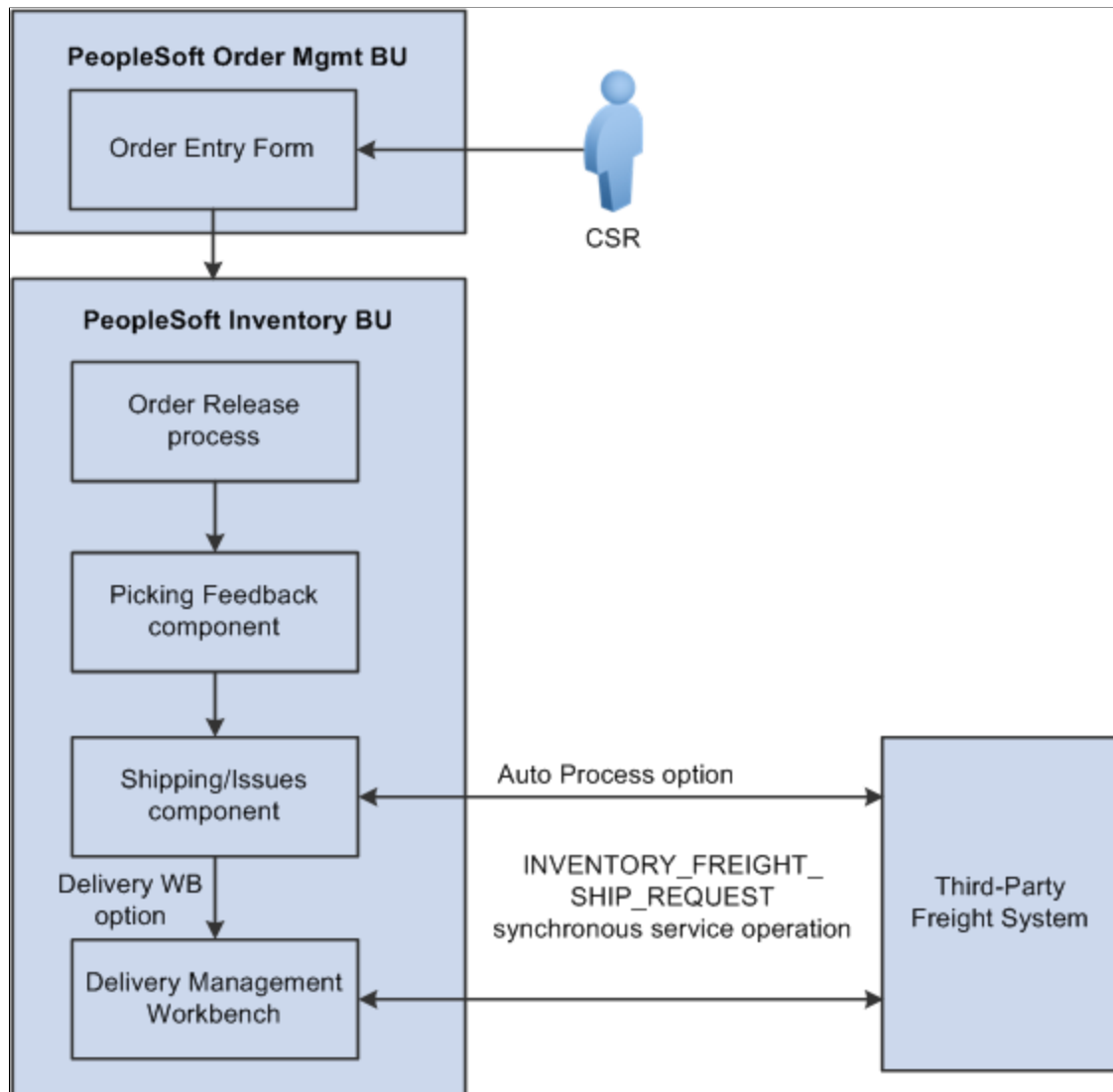

1. The CSR answers the phone and takes the customer's order. The CSR enters a sales order in PeopleSoft Order Management and saves the order. When the order is saved, the demand for the order lines is added to new or existing delivery IDs. In addition, assuming the Order Management business unit is configured appropriately, when the order is saved, it is automatically reserved and moved to a releasable fulfillment state.
2. The warehouse control manager runs the Order Release process and prints pick tickets for orders. The demand is set to the released fulfillment state and is ready to be picked.
3. The warehouse picker picks the order, enters picking feedback information into the Picking Feedback component, and advances the order to a confirmed fulfillment state. The items are moved to the shipping area.
4. The shipping clerk verifies that the order is ready for shipping and records the shipment in the Shipping/Issues component. When saving the shipment in the Shipping/Issues component, the system uses the value in the **Validate Delivery** field to validate the delivery to verify that all the demand for the delivery have shipped. Using the Validate Delivery field, the shipping clerk can tell the system to

automatically reassign demand that is not yet ready to ship to other existing or new deliveries. On the Shipping/Issues component, the shipping clerk has two options to freight and manifest the deliveries:

- The shipping clerk can choose the *Auto Process* option on the **Freight Option** field and then save the Shipping/Issues page to automatically perform a best way manifest option if a freight service definition does not currently exist on the delivery. If the delivery contains a freight service definition, then the delivery is manifested using that freight service definition.
 - The shipping clerk can choose the *Delivery Workbench* option on the **Freight Option** field and then save the Shipping/Issues page to access the Delivery Management Workbench where he can perform freight and manifesting. The Delivery Management Workbench can be used to view and manipulate the deliveries and request freight from the third-party system. Using the workbench, the shipping clerk can request rate shopping, best way, or specific carrier. In addition, the Delivery Management Workbench enables the shipping clerk to request that the third-party system assign the shipped items to a shipping manifest and return the shipping label URL references and tracking numbers to the PeopleSoft system.
5. In the third-party freight system:
 - The freight charges are calculated and sent to the PeopleSoft system.
 - The sales order can be added to the appropriate freight supplier's manifest.
 - Appropriate shipping labels can be printed and physically attached to the shipping container or package.
 - Tracking numbers are assigned and returned with the shipment response message to the PeopleSoft system. Tracking numbers are returned and maintained optionally at the delivery, shipping container, or package level. Label URL references can also be returned and maintained at the shipping container level and package level.
 - Based on your setup, specialized shipping documents, such as bill of lading and export documentations, can be printed from the third-party system.
 6. The freight charges, shipping labels, and tracking numbers are received into the PeopleSoft system. The delivery structure that goes out on the freight request transaction is also stored in the PeopleSoft system. As freight rates are returned they are maintained at the order, delivery, package, and shipping container level. The shipping labels can be printed from the PeopleSoft system. The tracking numbers are assigned to the delivery, packages, or shipping containers in the PeopleSoft system.
 7. The appropriate shipping documents are printed from the PeopleSoft system. Note that documents generated in the third-party system are printed from the third-party system.
 8. The order is depleted, invoiced, and costed in the PeopleSoft system.
 9. When the carrier arrives, the shipping manifest in the third-party freight system is provided to the driver along with any other shipping documents.

Example 6: Batch Assignment of Freight Charges and Manifest Data at Shipping Time

A shipping clerk can launch the Shipping Request process to move a group of sales orders into the Shipped fulfillment state. The shipping clerk can also direct the Shipping Request process to launch the Inventory Freight Ship Request EIP once the lines are in the Shipped state. The Inventory Freight Ship Request EIP transaction is sent out to the third-party freight provider to request freight rating and manifesting. The third-party freight system sends back freight amounts and carrier assignments. The third-party freight system can create and maintain the shipping manifests, then send the tracking numbers and label URL references to PeopleSoft to be stored in the shipping history tables. This service operation can only be initiated from the fulfillment engine processes when the delivery is ready for shipment.

In this example, the Shipping Request process page is used; however any of the following pages, processes, and EIPs can also be used launch the INVENTORY_FREIGHT_SHIP_REQUEST EIP once the orders are in the shipped state: the Picking Confirmation process page, the Process Deliveries/Freight process page (in the PeopleSoft Inventory menu), the Inventory Shipping EIP, the Front End Shipping Request process page, the Inventory Front End Shipping EIP, and the Fulfillment Workbench. When sending this transaction from the Process Deliveries/Freight process page (in the PeopleSoft Inventory menu) the manifest option can be selected even though the delivery is not yet shipped; you just need to make sure that the delivery is shipped before the response transaction is received in the PeopleSoft system.

Note: This example assumes that the PeopleSoft system and the third-party freight provider have been properly set up to accomplish this method of freight calculation.

The following diagram illustrates the business process flow of batch freight calculation and manifesting at shipping time.

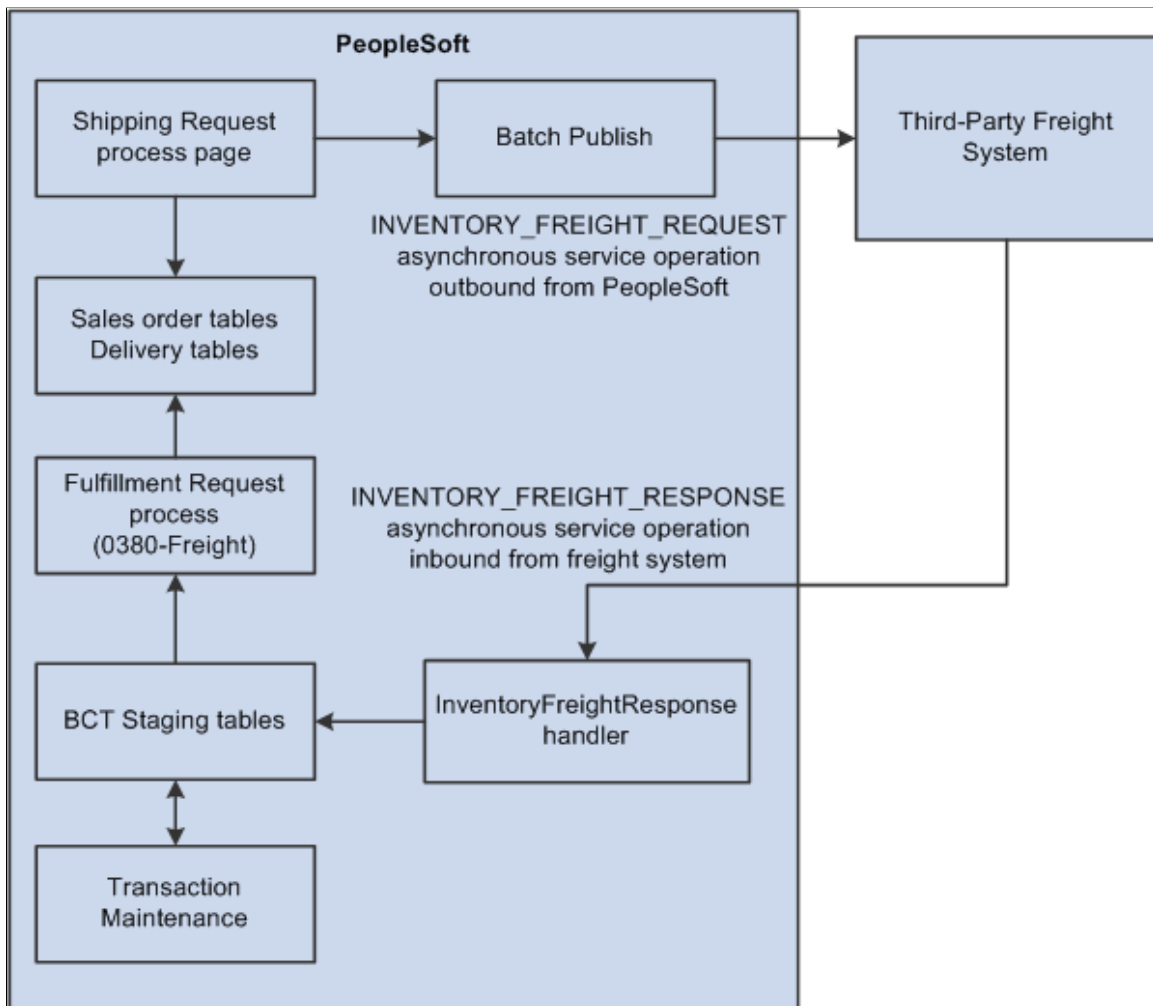

1. The Shipping Request process page is used to select a large batch of sales orders and move them to the shipped fulfillment state. This process completes several steps and can complete the following freight-specific steps:
 - Assembling the sales order lines into deliveries or validating existing deliveries. The delivery structure that goes out on the freight request transaction is also stored in the PeopleSoft system.
 - An Inventory Freight Request EIP transaction is sent out to the third-party freight provider to request freight rating and manifesting. On the Shipping Request process page, you can request the following freight options: Best Way, Use Specific Carrier, or Carrier with Best Way. The Rate Shopping freight option is only available from an online interactive page, not a process page or EIP.
2. The Batch Publisher process publishes the deliveries from the Shipping Request process.
3. Later, the third-party freight system sends an asynchronous rate-results transaction (Inventory_Freight_Response EIP) that provides the resulting freight charges for the delivery IDs associated with the sales order lines. The third-party freight system can also:

- Add the sales order to the appropriate freight supplier's manifest.
 - Create the appropriate shipping labels for the shipping containers or packages.
 - Assign tracking numbers at the delivery, shipping container, or package level.
 - Generate specialized shipping documents, such as bill of lading and export documentations.
4. The PeopleSoft Integration Broker receives the inbound XML message into the INVENTORY_FREIGHT_RESPONSE queue. The InventoryFreightResponse handler, a PeopleTools application class, formats the incoming data and populates the BCT staging tables. For each transaction request, the InventoryFreightResponse handler assigns a unique ID called the EIP_CTL_ID.
 5. The Fulfillment Requests process (IN_FUL_BCT) using the 0380 transaction code (Freight) retrieves the transaction requests from the staging tables, processes them, and applies them to the PeopleSoft production tables. The deliveries for the sales orders are updated with the appropriate carrier, freight charges, tracking numbers, and label URL references. As freight rates are returned they are maintained at the order, delivery, package, and shipping container level. The tracking numbers are assigned to the delivery, packages, or shipping containers in the PeopleSoft system. Once the rate-results transaction has been processed in the PeopleSoft system, for the impacted delivery IDs, then the Manifest Status field on the IN_DELIVERY table is changed to *Manifest Received*.
 6. If the transaction requests are not processed successfully, they are given an error status, and the appropriate error message is provided. The Maintain Transactions component enables you to view and correct requests that contain errors. Once corrected, you can relaunch the Fulfillment Requests process. This is an optional step, you can choose to have the request errors canceled automatically, and then you could create another request.
 7. The appropriate shipping documents are printed from the PeopleSoft system. Note that documents generated in the third-party system are printed from the third-party system.
 8. The sales orders are depleted, invoiced, and costed in the PeopleSoft system.
 9. When the carrier arrives, the shipping manifest in the third-party freight system is provided to the driver along with any other shipping documents.

Setting Up External Third-Party Freight Charges

The PeopleSoft system passes information to the third-party freight providers using deliveries. The delivery is the basic structure for integration with external freight providers. Many third-party freight systems enable you to calculate freight at the package level within the delivery and PeopleSoft supports this level of freight detail; however, the entire delivery is passed to the third-party system for freight calculation. The packages or shipping containers associated with the delivery may be freighted independently in the third-party system, but all packages and shipping containers for the delivery must be processed in the same transaction in the PeopleSoft system.

Understanding Freight Charges Documentation

The documentation for freight setup has been divided into three parts:

1. *Basic Setup:* This section discusses the freight setup steps that are needed for all freight configurations. This section must be complete before the setup steps for the external third-party freight charges.

See [Setting Up Basic Information for Freight Charges](#).

2. *Internal Freight Calculator Setup:* This section discusses the additional setup steps to use the PeopleSoft internal freight calculator. Basic setup is also required.

See [Setting Up the PeopleSoft Internal Freight Calculator](#).

3. *External Third-Party Setup:* This section discusses the additional setup steps needed to integrate PeopleSoft with a third-party freight provider. Basic setup is also required. The following section discusses these setup steps.

Setup Steps for Integration with an External Third-Party Freight Provider

The following diagram displays the setup steps for the PeopleSoft external third-party freight feature. These steps involve pages in PeopleSoft Inventory, PeopleSoft Order Management, and PeopleSoft Integration Broker.

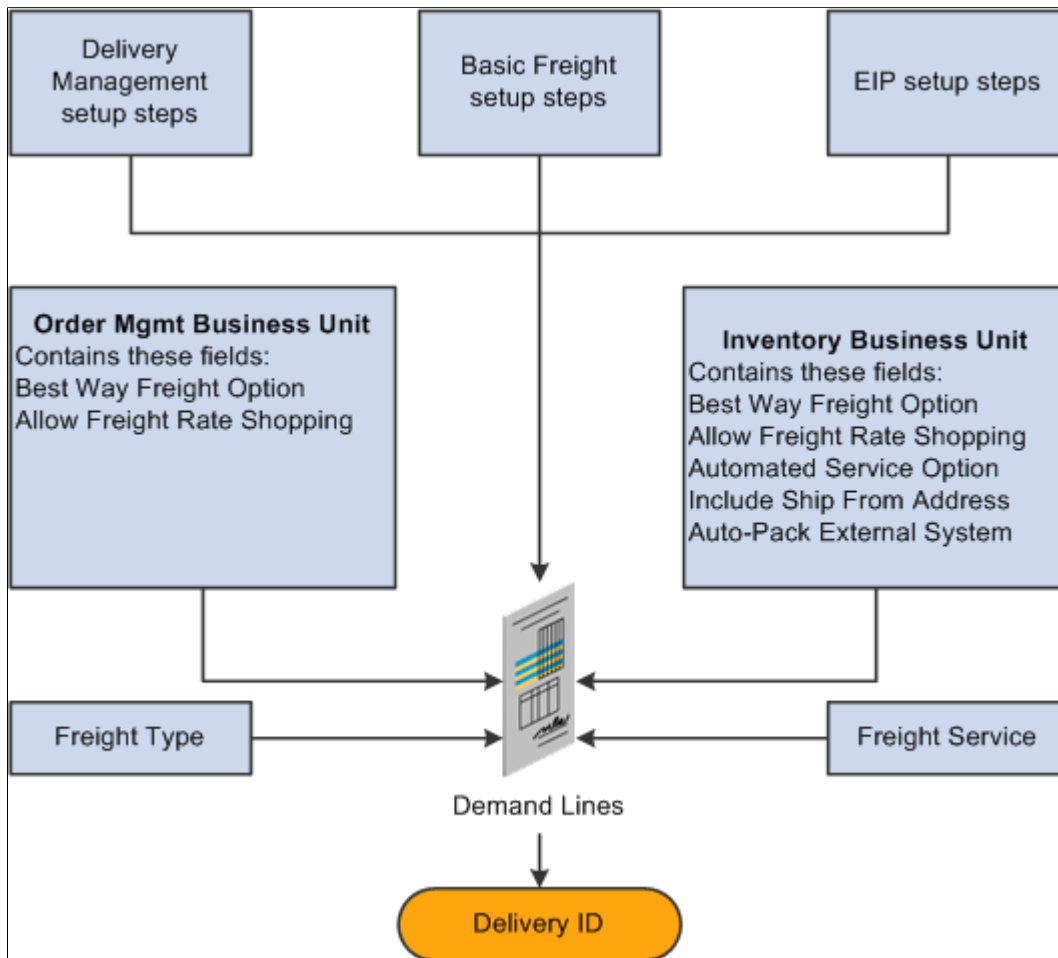

Certain system values must be defined to configure the third-party integration. These values include:

Field or Control	Description
Delivery Management Setup Steps	<p>Delivery management is required for both internal and external freight calculations. See Setting Up Delivery Management for instructions and setup steps. Complete the setup for the delivery management feature before using the freight charges feature.</p> <p>See Setting Up Delivery Management.</p>
Basic Freight Setup Steps	<p>To enable the external freight charges from a third-party provider, you must also complete the setup of the basic information for freight charges. See Setting Up Delivery Management for instructions and setup steps.</p> <p>See Setting Up Basic Information for Freight Charges.</p>
EIP Setup Steps	<p>Activate the enterprise integration points (EIPs) to send and receive data between PeopleSoft and your third-party freight system. These EIPs are implemented using service operations in the PeopleSoft Integration Broker. Setting up service operations involve a number of steps, involving queues, handlers, routings, transformation programs, nodes, and other components. See "Integration Implementation" (PeopleSoft Supply Chain Management Integration).</p> <p>See "Setting Up Service Operations" (PeopleSoft Supply Chain Management Integration).</p>

Field or Control	Description
Best-Way Freight Option	<p>When you select a best-way freight option, the system sends a best-way request to the third-party provider system. The third-party provider uses this option to provide the single best choice across all carriers, the single best choice for a specified carrier, or to prioritize the results displayed.</p> <p>The best-way freight option does not drive any logic in the PeopleSoft system. This option is passed to the third-party freight provider so it can use the option to perform best-way processing. The third-party system then makes sure that the best way service provider is the first shipment node on the response.</p> <p>The options are:</p> <ul style="list-style-type: none"> • <i>Least Cost:</i> The third-party freight system selects and returns the freight service with the least cost for the delivery. • <i>By Commit Date:</i> The third-party freight system selects and returns the freight service that provides the fastest delivery to the customer. <p>The Best-Way Freight Option field is located on:</p> <ul style="list-style-type: none"> • The Shipping and Returns page of the Order Management business unit definition. This value is supplied by default to the sales order entry and the Order Completion process. • The Setup Fulfillment-Delivery/Freight page in PeopleSoft Inventory. The value is supplied by default to the Delivery Management Workbench, the Fulfillment Workbench, the Material Picking Feedback page, the Picking Confirmation process page, the Process Deliveries/Freight process page (in the PeopleSoft Inventory menu), the Shipping/Issues component, the Shipping Request process page, the Inventory Shipping EIP, the Front End Shipping Request process page, and the Inventory Front End Shipping EIP.

Field or Control	Description
<p>Allow Freight Rate Shopping</p>	<p>This field identifies whether the interfacing third-party freight system allows rate shopping. Rate shopping enables a user to choose which freight carrier and charges to use on the delivery based on the choices retrieved from the third-party freight provider. This method displays the Freight Rate Shopping page for users to view, evaluate, and select the best freight carrier for their needs. Rate shopping can be performed from the Order Entry Form and from the Delivery Management Workbench. In addition, freight rate shopping can be performed for a quote.</p> <p>The options are:</p> <ul style="list-style-type: none"> • <i>Always</i>: The user must perform freight rate shopping. • <i>Never</i>: Freight rate shopping is not available. • <i>Optional</i>: The user can select freight rate shopping. <p>The Allow Freight Rate Shopping field is located on:</p> <ul style="list-style-type: none"> • The Shipping and Returns page of the Order Management business unit definition. When you request third-party freight charges at order entry time (Order Entry Form component), the system looks to this Order Management business unit setting to determine whether freight rate shopping is allowed. • The Setup Fulfillment-Delivery/Freight page in PeopleSoft Inventory. When you request third-party freight charges using the Delivery Management Workbench, the system looks to this Inventory business unit setting to determine whether freight rate shopping is allowed. <p>For freight rate shopping at order entry time, the Allow Freight Rate Shopping field works with the online Process Freight Charges field on the Order Entry Features page within the Order Management business unit definition. If the value is <i>None</i> in the Process Freight Charges row and the Online column, the freight rate shopping cannot be performed from the Order Entry Form component. If the value is <i>Manual</i> or <i>Online</i> in the Process Freight Charges row and the Online column, the freight rate shopping can be performed if the Allow Freight Rate Shopping field is <i>Always</i> or <i>Optional</i>.</p>

<i>Field or Control</i>	<i>Description</i>
Freight Type Code	<p>Identifies the generally accepted types of freight services used with a third-party freight system. Freight types are defined at the SetID level and used to derive the correct service definition to send with the outbound message to the third-party provider. Some third-party providers use the service definition to determine which freight service should be used. The user can select a specific freight type code in the Delivery Management Workbench or at shipping time.</p> <p>If the freight type code is used in combination with the Automated Service Option field, then the freight type code helps to filter the service definitions sent to the external third-party freight provider. If the freight type code is used without the automated service option then the freight type code is a memo only field that is sent out on the outbound freight transaction.</p>
Automated Service Option	<p>On the Setup Fulfillment- Delivery/Freight page, select the Automated Service Option check box in order to send freight service definition information on the transaction requests between PeopleSoft and the external third-party freight system.</p>

Field or Control	Description
<p>Freight Service</p>	<p>A freight service definition provides a cross-reference between the combination of the PeopleSoft fields of Carrier ID, Ship Via, and Freight Type Code to the same information within the third-party freight system. Freight service definitions are created by the external third-party freight system and some freight systems require this field on the transaction requests.</p> <p>The Inventory business unit fulfillment setup <i>Automated Service Option</i> defines whether the freight service definition is used with the third-party integration.</p> <p>At shipping time or in the Delivery Management Workbench, the user can select a freight type code to narrow the freight assignment options.</p> <p>If the delivery is defined by carrier ID or if the user is freighting for a specific carrier ID, the system uses the freight type code, carrier ID, and ship-via (optional) on the delivery to determine which freight service definition to send with the outbound message to the third-party provider. If no freight type code is entered prior to freighting, the system fetches the service definitions for the carrier and ship-via (optional) on the delivery and selects and sends all service definitions for that combination. The third-party system returns a single freight option for that carrier and freight service definition.</p> <p>If the user is performing best-way freighting, the system uses the freight type code and sends all the freight service definitions for that freight type code on the outbound message. If no freight type code is entered, the system sends all the service definitions for the SetID on the outbound message. The third-party system returns the best-way freight option (only one) of the service definitions provided in the message. Any time that a service definition is entered directly on the delivery, then only that service definition is sent for best way and specific carrier processing.</p>

Field or Control	Description
Auto-Pack External System	<p>Indicates whether the third-party freight provider should automatically consolidate individual demand lines in a delivery into packages. The third-party system will return freight for the packages.</p> <p>Some third-party freight providers have functionality to automatically combine loose stock into packages based on packaging algorithms. This field can be used to tell the third-party system to use these routines to estimate how many packages and the weight and volume of these packages for freighting purposes. If the Auto-Pack External System field is set to <i>no</i>, then the third-party freight system would assume that each individual quantity in the shipping unit of measure is a packaging unit.</p>

Pages Used to Set Up Third-Party Freight Charges

Page Name	Definition Name	Usage
Shipping and Returns Page	BUS_UNIT_TBL_OM6	Enter the best-way freight option and the freight rate shopping values for this Order Management business unit.
Setup Fulfillment - Delivery/Freight Page	OF_SETUP10_INV	Enter the best way freight option, the freight rate shopping values, automated service option, and auto-pack on external system setting for this inventory business unit.
Setup Item Fulfillment Page	OF_SETUP_IT_INV	Enter the auto-pack on external system setting for this item ID and inventory business unit combination.
Order Group Shipping Terms Page	ORD_GROUP_TERMS	Define the Use Preferred Freight Carrier field at the order group level.
General Information - Ship To Options Page	CUST_SHIPTO_OPT1	Define the Use Preferred Freight Carrier field at the customer level.
Buying Agreements - Header Terms Page	SCON_HDR_TRMS	Define the Use Preferred Freight Carrier field for a buying agreement.
<u>Maintain Freight Types Page</u>	IN_FRT_DFLT	Create freight type codes at the SetID level to identify the generally accepted types of freight services to use with a third-party freight system.

Page Name	Definition Name	Usage
<u>Maintain Freight Services Page</u>	IN_FRT_SRV	Create freight services at the SetID level to identify a unique combination of a freight type code, carrier ID, and ship via code. All freight services for a freight type code are included on the outbound freight transaction if the user has requested that these services be provided.
TableSet Control - Record Group Page	SET_CNTRL_TABLE1	Select the SetID for the record group, IN_18, Freight Options to link the freight service definitions at the SetID level to the business unit (set control value). This record group is used with the Maintain Freight Services page.

Maintain Freight Types Page

Use the Maintain Freight Types page (IN_FRT_DFLT) to create freight type codes at the SetID level to identify the generally accepted types of freight services to use with a third-party freight system.

Navigation:

Set Up Financials/Supply Chain > Common Definitions > Shipping and Receiving > Maintain Freight Types

This example illustrates the fields and controls on the Maintain Freight Types page at the SetID level. You can find definitions for the fields and controls later on this page.

The screenshot shows the 'Maintain Freight Types' page for SetID SHARE. It features a table with the following data:

Freight Type Code	Description	*Type Indicator		
EXPRESS	Express - Three days or less	Parcel	+	-
GROUND	Ground Services	Parcel	+	-
OVERNIGHT	Overnight Services	Parcel	+	-

Use the Maintain Freight Types page to define freight types used with the external third-party freight system. When defining your freight type, define the type indicator. The freight type is used to help define a unique combination of a freight service definition on the Maintain Freight Services page.

Field or Control	Description
Freight Type Code	Enter the freight type code to be used in your environment. Use the Add Row icon to insert as many rows as needed.
Type Indicator	For future use.

Maintain Freight Services Page

Use the Maintain Freight Services page (IN_FRT_SRV) to create freight services at the SetID level to identify a unique combination of a freight type code, carrier ID, and ship via code.

All freight services for a freight type code are included on the outbound freight transaction if the user has requested that these services be provided.

Navigation:

Set Up Financials/Supply Chain > Common Definitions > Shipping and Receiving > Maintain Freight Services

This example illustrates the fields and controls on the Maintain Freight Services page at the SetID level.

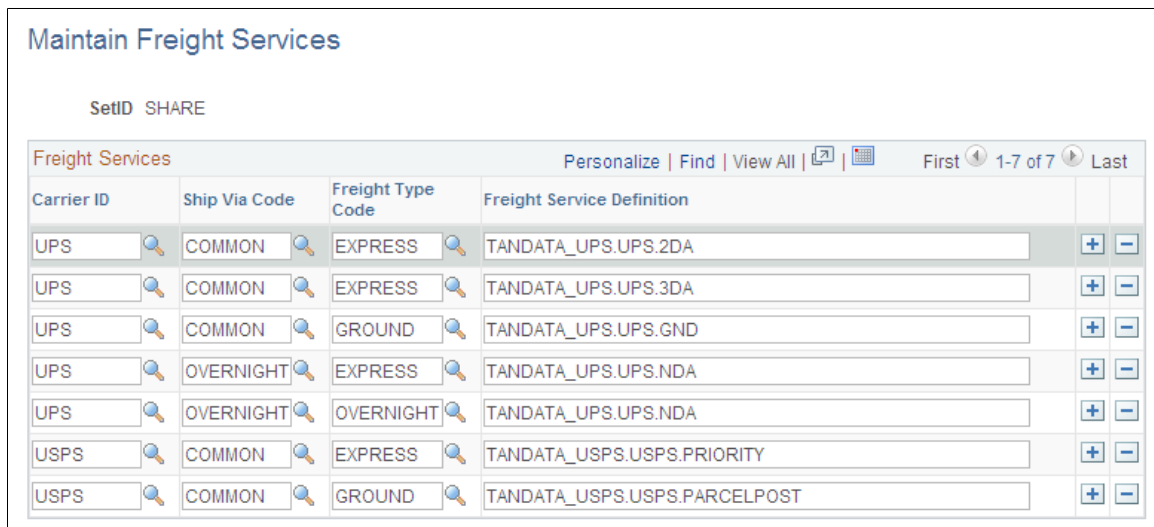

The screenshot shows the 'Maintain Freight Services' page for SetID 'SHARE'. It features a table with columns for Carrier ID, Ship Via Code, Freight Type Code, and Freight Service Definition. Each row includes search icons and add/delete buttons. The table contains the following data:

Carrier ID	Ship Via Code	Freight Type Code	Freight Service Definition		
UPS	COMMON	EXPRESS	TANDATA_UPS.UPS.2DA	+	-
UPS	COMMON	EXPRESS	TANDATA_UPS.UPS.3DA	+	-
UPS	COMMON	GROUND	TANDATA_UPS.UPS.GND	+	-
UPS	OVERNIGHT	EXPRESS	TANDATA_UPS.UPS.NDA	+	-
UPS	OVERNIGHT	OVERNIGHT	TANDATA_UPS.UPS.NDA	+	-
USPS	COMMON	EXPRESS	TANDATA_USPS.USPS.PRIORITY	+	-
USPS	COMMON	GROUND	TANDATA_USPS.USPS.PARCELPOST	+	-

Use the Maintain Freight Services page to enter freight service definitions created by the external third-party freight system. A freight service definition provides a cross-reference between the combination of the PeopleSoft fields of Carrier ID, Ship Via, and Freight Type Code to the same information within the third-party freight system. For example, you can link the combination of carrier ID *USPS* (United States Postal Service), ship via code *Common*, and freight type *Express* to the freight service definition of FREIGHTSYSTEM_USPS.NDA (United States Postal Service next day air within external freight system).

To setup freight service definitions:

- On this page (Maintain Freight Services page), enter freight service definitions provided by your external third-party freight system along with the PeopleSoft field values for carrier, ship via, and freight type. This page records the freight service definitions at the SetID level.

- On the TableSet Control - Record Group page, enter the SetID on the record group, IN_18 (Freight Options) for one or more PeopleSoft Inventory business units (set control value).
- On the Setup Fulfillment- Delivery/Freight page, select the Automated Service Option check box in order to send freight service definition information on the transaction requests between PeopleSoft and the external third-party freight system.

When needed by the third-party freight system, the correct freight service definition (for the combination of carrier, ship via, and freight type on the delivery) is sent on the outbound transaction request and also contained on the inbound transaction request. If the system finds more than one freight service definition with matching carrier, ship via, and freight type, then all matching freight service definitions are sent on the outbound transaction request. If the system cannot find a freight service definition with the exact combination of carrier, ship via, and freight type, then the system uses the freight service definition with the closest match as follows:

- If the delivery is defined by carrier ID or if the user is freighting for a specific carrier ID, the system uses the freight type code, carrier ID, and ship-via (optional) on the delivery to determine which freight service definition to send with the outbound message to the third-party provider. If no freight type code is entered prior to freighting, the system fetches the service definitions for the carrier and ship-via (optional) on the delivery and sends all the service definitions with the matching combination. The third-party system can return a single service definition or multiple service definitions. If multiple service definitions are on the inbound transaction, then the PeopleSoft system selects the first service definition.
- If the user is performing best-way freighting, the system uses the freight type code and sends all the freight service definitions for that freight type code on the outbound message. If no freight type code is entered, the system sends all the service definitions for the SetID on the outbound message. The third-party system returns the best-way freight option (only one) of the service definitions provided in the message. Any time that a service definition is entered directly on the delivery, then only that service definition is sent for best way and specific carrier processing.

In addition, the freight service definition can be added to the delivery on the Delivery Management Workbench-Manage Delivery page.

Enabling the PeopleSoft EIPs for Third-Party Freight

PeopleSoft communicates with the external third-party freight system using enterprise integration points (EIPs). The third-party freight EIPs are service operations in the PeopleSoft Integration Broker that are used to send messages (transaction requests) with sales order and delivery data to a third-party freight provider and receive back freight charges, carrier assignments, tracking numbers, and label URL references to the PeopleSoft system. The following service operations are used:

- *Inventory Freight Rate Request:* This synchronous (two-way) service operation is used from the Order Entry Form and the Delivery Management Workbench to send a freight request transaction request and receive an immediate response from the third-party freight system. Using these online pages, a user can request rate shopping, best way, or a specified carrier.
- *Inventory Freight Request:* This asynchronous (one-way) service operation is used by the Order Completion process, the fulfillment engine shipping processes, and the Process Deliveries/Freight process to send a freight request transaction request to the third-party system. The delivery can use

best way or specified carrier. This method is used when an immediate response is not needed, such as requesting freight through a background process or for a batch of orders.

When using the Inventory Freight Request EIP you can send a freight rating request with or without a manifesting of the shipment. You always generate a non-manifesting freight request when making this request from the Order Completion process or from the Process Deliveries/Freight process within the Order Management menu. When making this request from the fulfillment engine shipping processes, you always generate a manifesting freight request. When making this request from the Process Deliveries/Freight process within the Inventory menu, you can generate a manifesting or non-manifesting freight request based on the External Manifest check box on the process page.

- *Inventory Freight Response:* This asynchronous (one-way) service operation is used by the external third-party system to respond to the Inventory Freight Request service operation transaction request. In addition, the third-party freight system can use the Inventory Freight Response service operation by itself to initiate the data transfer by passing freight amounts to PeopleSoft without first receiving an Inventory Freight Request transaction request. The data from an Inventory Freight Response transaction request updates the sales order and delivery tables in PeopleSoft after it is received into PeopleSoft using the Inbound Freight process. The Inbound Freight process is initiated using the Fulfillment Requests process page (SCM Integration, Process Transactions, Inventory, Fulfillment Requests).
- *Inventory Freight Ship Request:* This synchronous (two-way) service operation is used from the Delivery Management Workbench or the Shipping/Issues component to send a freight request message and receive an immediate response from the third-party freight system. Using the Delivery Management Workbench, a user can request rate shopping, best way, or a specified carrier. In addition, this service operation enables you to request manifesting. The third-party freight system can create, maintain, and print the shipping manifests, then send tracking numbers and label URL references to PeopleSoft to be stored in the shipping history tables. This service operation can only be initiated for deliveries that have been shipped.

Using the Third-Party Freight Transformation Programs

When interfacing to a third-party system the XML messages sent to those systems need to be mapped from the PeopleSoft XML format to the third-party system's XML format. This mapping process is done by a transform program written specifically for that third-party transformation and initiated by identifying that program in the Routings-Parameters page of the routing definition. The routing is defined on the service operation. To assist with this process, PeopleSoft has provided some sample transform programs. These transform programs are identified in the routings for the INVENTORY_FREIGHT_RATE_REQUEST and INVENTORY_FREIGHT_SHIP_REQUEST service operations.

The sample transform programs serve two purposes:

- First, they provide an example of how a transform program can be used working with the PeopleSoft Integration Broker to transform PeopleSoft XML to that of a third-party system. These programs are PeopleSoft Application Engine programs that provide an example of how both PeopleCode and XSLT can be used in the transformation process.
- Second, these transform programs provide a working demo environment with a third-party system. The programs were written to work with the ConnectShip Prologistics XML APIs. If the ConnectShip system is installed in a demo environment accessible by the PeopleSoft demo system, then these transform programs can be activated. This enables you to set up a working demo showing how freight ratings can be accessed using the Create/Update Quote, Create/Update Order, Delivery

Management Workbench, and the Shipping/Issues components. For information on how to download a ConnectShip demo system go to www.connectship.com.

Note: The sample transform programs were written to work in a demo environment and are not intended to be used in a live production environment without making changes tailored to that specific production environment.

Setting Up the Third Party Freight System EIPs

PeopleSoft delivers the service operations in PeopleSoft Integration Broker with a default status of *Inactive*. You must activate each service operation before attempting to send or receive data from a third-party source. To set up these service operations:

1. Complete the setup for the third-party freight feature within the PeopleSoft Inventory and Order Management applications.
2. Set up the service operations within PeopleSoft Integration Broker and Enterprise Components.

Use the information in the following table and refer to the setup instructions in "Setting Up Service Operations" (PeopleSoft Supply Chain Management Integration).

Service Operation	Direction and Type	Handlers	Chunking Available?	Integrates With
INVENTORY_ FREIGHT_RATE_ REQUEST	Outbound Synchronous		no	Third-party system synchronous freight rate request and response
INVENTORY_ FREIGHT_REQUEST	Outbound Asynchronous	ROUTERSENDHDLR	yes	Third-party system asynchronous freight rate request
INVENTORY_ FREIGHT_ RESPONSE	Inbound Asynchronous	Inventory FreightResponse		Third-party system asynchronous freight rate response
INVENTORY_ FREIGHT_SHIP_ REQUEST	Outbound Synchronous		no	Third-party system synchronous freight and manifest request and response

Pages Used to Integrate PeopleSoft with the Third-Party Freight System

<i>Page Name</i>	<i>Definition Name</i>	<i>Usage</i>
Service Operations-General Page	IB_SERVICE	Define and activate a service operation. Before transmitting data, you must perform the setup steps to activate the service operations. This is a setup step that is not repeated for each transaction request.
<u>Message Definition Page</u>	IB_MESSAGE_BUILDER	View the fields to be used by the service operation within PeopleSoft Integration Broker. In order to correctly populate the outgoing and incoming data, the message definition will be reviewed. This is a setup step that is not repeated for each transaction request.
Routings-Parameters Page	IB_ROUTINGDEFNDOC	Set up routing parameters including transform programs. The routings are defined on the service operations.

Message Definition Page

Use the Message Definition page (IB_MESSAGE_BUILDER) to view the fields to be used by the service operation within PeopleSoft Integration Broker.

In order to correctly populate the outgoing and incoming data, the message definition will be reviewed. This is a setup step that is not repeated for each transaction request.

Navigation:

PeopleTools > Integration Broker > Integration Setup > Messages > Message Builder

This example illustrates the fields and controls on the The inventory freight rate request message definition (part 1 of 2).

Message Definition

Schema

Message: INVENTORY_FREIGHT_RATE_REQUEST

Version: VERSION_1

Description:

Owner ID:

Comments:

Schema Exists: Yes

Part Message

Exclude Description in Schema

Single Level 0 Row

Include Namespace

Suppress Empty XML Tags

Message Type

Rowset-based

Nonrowset-based

Container

Service Operation References

View Records Only View Included Fields Only Add Record to Root

Left | Right

INVENTORY_FREIGHT_RATE_REQUEST

- IN_OFRT_HDR_EC
- EIP_CTL_ID
- BUSINESS_UNIT
- DELIVERY_ID
- IN_CHUNK_NBR
- CARRIER_ID
- SHIP_TYPE_ID
- FRT_TYPE_CODE
- FRT_SRVC_DEFN
- FRT_REF_NO
- FREIGHT_TERMS
- IST_DELIVERY_TRM1
- IN_FRT_OPTION
- IN_BEST_WAY_BTN
- SETID_CUSTOMER
- SHIP_TO_CUST_ID
- ADDRESS_SEQ_NUM
- SETID_LOCATION
- LOCATION

This example illustrates the fields and controls on the The inventory freight rate request message definition (part 2 of 2).

The screenshot displays a list of fields for the message definition. Each field is preceded by a blue diamond icon containing a checkmark or a plus sign. The fields are:

- SHIP_CUST_NAME1
- SHIP_CUST_NAME2
- SHIP_DTTM
- SHIP_DATE_TXT
- CURRENCY_CD
- TOTAL_ORD_AMT
- TOTAL_NBR_PIECES
- TOTAL_WEIGHT
- TOTAL_VOLUME
- UNIT_MEASURE_WT
- UNIT_MEASURE_VOL
- CONTAINER_TYPE
- CNTR_UOM_WT
- CNTR_UOM_VOL
- CNTR_UOM_DIM
- SHIP_LENGTH
- SHIP_WIDTH
- SHIP_HEIGHT
- MAX_WEIGHT
- EMPTY_WEIGHT
- EXPORT
- MANIFEST_FLG
- REGEN_MSG_FLG
- LOOSE_STOCK_FLAG
- PROCESS_INSTANCE
- IN_PROCESS_FLG
- AUDIT_ACTN
- IN_OFRT_SFRM_EC
- IN_OFRT_STO_EC
- IN_OFRT_ITEM_EC
- IN_OFRT_PKG_EC
- IN_OFRT_SVC_EC

At the bottom of the list, there are two buttons: "Save" and "Save As". Below the buttons, there is a link "Return to Search" and a breadcrumb "Message Definition | Schema".

In order to correctly populate the outgoing data, some of the important fields in the INVENTORY_FREIGHT_RATE_REQUEST message definition will be reviewed. Message definitions provide the physical description of the data that is being sent, including; fields, field types, and field lengths. Messages do not contain any processing logic. All processing logic is defined in service operations, using service operation handlers. The INVENTORY_FREIGHT_RATE_REQUEST message is used by the following service operations; INVENTORY_FREIGHT_RATE_REQUEST (synchronous), INVENTORY_FREIGHT_REQUEST (asynchronous using the INVENTORY_FREIGHT_REQUEST queue), and INVENTORY_FREIGHT_SHIP_REQUEST (synchronous).

This message structure contains:

Outbound Freight Request IN_OFRT_HDR_EC (Header):

- IN_OFRT_SFRM_EC (Ship From Address)
- IN_OFRT_STO_EC (Ship To Address)
- IN_OFRT_ITEM_EC (Item Level)
- IN_OFRT_PKG_EC (Package Level) with IN_OFRT_PITM_EC (Package Item Level)

- IN_OFRT_SVC_EC (Service Level for best way & rate shopping)

For more information, see *PeopleTools: Integration Broker*.

See the product documentation for *PeopleTools: Integration Broker*

Using the Internal PeopleSoft Freight Calculator

Understanding Internal Freight Charges

Internal freight calculation is freight that is calculated using the PeopleSoft freight definitions. Alternatively, you can integrate with a third-party freight provider to calculate your sales order and shipping freight. Internal freight can be calculated in the sales order or quote in PeopleSoft Order Management or in demand fulfillment in PeopleSoft Inventory, including shipping. Whether performing internal or external freight calculation, you can also manually enter freight amounts in PeopleSoft Order Management or in PeopleSoft Inventory. This topic discusses the setup of PeopleSoft Order Management and Inventory to internally calculate freight charges. For quotes or sales orders, you can add freight costs during quote or order entry in PeopleSoft Order Management or you can add freight costs during the packing and shipping stages of PeopleSoft Inventory.

Setting Up the PeopleSoft Internal Freight Calculator

Deliveries are used to pass data to the internal freight calculator and calculate the freight charges. With internal freight, freight is calculated only at the delivery level. The field values within the delivery ID determine how freight charges are calculated. The delivery field values that are captured and used to determine a delivery are defined in the delivery key configuration setup for the Inventory business unit. A few required key values exist, such as inventory business unit and scheduled ship date. Other values can be configured for each business unit. In PeopleSoft Order Management and Inventory, deliveries can be automatically created by the system.

Understanding Freight Charges Documentation

The documentation for freight setup has been divided into three parts:

1. *Basic Setup*: This section discusses the freight setup steps that are needed for all freight configurations. This section must be complete before the setup steps for the internal freight calculator.

See [Setting Up Basic Information for Freight Charges](#).

2. *External Third-Party Setup*: This section discusses the additional setup steps needed to integrate PeopleSoft with a third-party freight provider. Basic setup is also required.

See [Setting Up External Third-Party Freight Charges](#).

3. *Internal Freight Calculator Setup*: This section discusses the additional setup steps to use the PeopleSoft internal freight calculator. Basic setup is also required. The following section discusses these setup steps.

Setup Steps for the PeopleSoft Internal Freight Calculator

This section discusses the setup steps needed to use the PeopleSoft internal freight calculator to add freight charges on your sales orders. In addition to the setup discussed in this section, you must complete the basic setup steps for freight charges located in the Setting Up Delivery Management and Freight Calculations topic of this documentation.

The following diagram displays the setup steps for the PeopleSoft internal freight calculator.

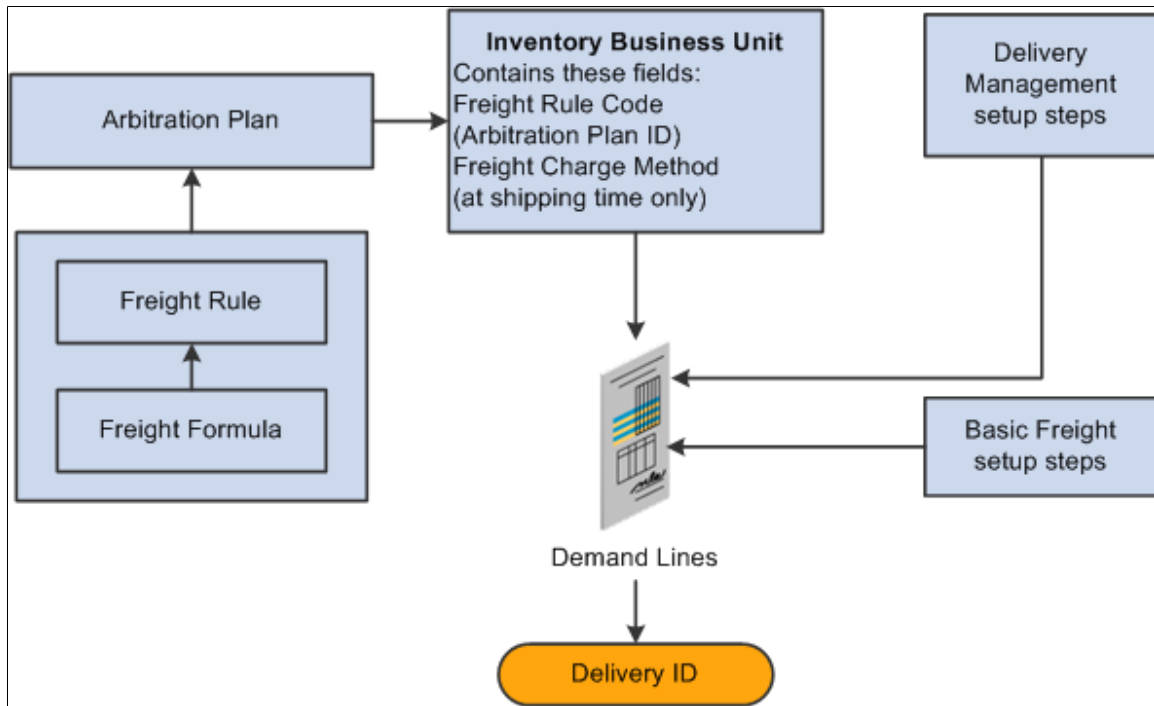

Setup steps include:

Field or Control	Description
Delivery Management Setup Steps	Delivery management is required for both internal and external freight calculations. See Setting Up Delivery Management or instructions and setup steps. Complete the setup for the delivery management feature before using the freight charges feature.
Basic Freight Setup Steps	To enable the PeopleSoft internal freight calculations, you must also complete the setup of the basic information for freight charges. See Setting Up Basic Information for Freight Charges .

Field or Control	Description
Freight Rule Code	Identifies the arbitration plan ID for calculating freight. This field determines how the system applies freight rules and freight formulas when calculating freight charges internally. This field is on the Inventory Definition - Business Unit Options: Shipping Options page and applies only to sales orders.
Freight Rule/Freight Formulas	Freight rules and freight formulas define the freight charges that can be applied to a delivery ID. A freight charge can be a flat amount or a percentage of value of the delivery. Defining freight charge as a percent of the delivery value is available only for internal freight calculation in order entry.
Arbitration Plan	Use the arbitration plan for freight and transportation to define which freight rule is selected and applied to the delivery ID. If more than one freight rule matches the delivery values, the first rule, prioritized based on the arbitration plan, is applied to the delivery.

Pages Used to Set Up the PeopleSoft Internal Freight Calculator

Page Name	Definition Name	Usage
Inventory Definition - Business Unit Options: Shipping Options Page	BUS_UNIT_INV2	Enter the freight arbitration plan and the freight charge method to be used for this inventory business unit for calculating PeopleSoft internal freight charges.
Order Groups Page	ORD_GROUP	(optional) Define the freight charge method for the order group level.
General Information - Sold To Options Page	CUST_SOLDTO_OPT	Define the freight charge method for the customer.
Buying Agreements - Header Terms Page	SCON_HDR_TRMS	(optional) Define the Freight Charge Method field for a buying agreement.

Page Name	Definition Name	Usage
Arbitration Plan Page	TRFT_RULE_CD	Establish arbitration plans for freight charges. The freight arbitration plan determines the sequence in which the system searches for and applies freight charges to a delivery. The arbitration plan is entered into the Freight Arbitration Plan field on the Inventory Definition - Business Unit Options: Shipping Options page and is used for internal freight calculations for sales orders.
Freight Formulas Page	TRFT_FRT_BREAK	Using the freight charge method, enter the freight charges to be applied to a delivery. Freight formulas are defined within a freight rule. Freight rules are applied to a sales order delivery based on the arbitration plan and the freight charge method used.

Chapter 5

Using Delivery Management and Freight Calculations

Understanding Delivery Management and Freight Calculations

The delivery management and freight calculation features in PeopleSoft Inventory and PeopleSoft Order Management enable you to group demand lines for shipment and apply freight charges. The freight feature applies only to sales orders and quotes from PeopleSoft Order Management. Delivery IDs are required for the freight calculation feature.

Using the Delivery Management Workbench

The Delivery Management Workbench enables you to:

- Create deliveries.
- Change or maintain existing deliveries.
- Assign demand lines, shipping containers and packages to the deliveries.
- Shop for freight and manifest the deliveries.

You can use the Delivery Management Workbench with the third-party freight providers or the PeopleSoft internal freight calculation.

The Delivery Management Workbench component includes the following main pages:

- The Workbench Navigation Menu is the first page displayed in the workbench. From this page you can access the main pages of the workbench.
- The Deliveries page enables you to select one or more deliveries based on various search criteria. You can perform delivery and freight actions on one or more deliveries at once. You can consolidate deliveries or calculate freight for multiple selected deliveries, or you can choose a single delivery to perform freight calculation.
- The Demand / Container Activities page enables you to add or remove items from a delivery. Assign demand lines or shipping containers to an existing delivery or create a new delivery to hold them. You can also remove demand lines and shipping containers from a delivery and consolidate deliveries.
- The Manage Delivery page enables you to maintain one individual delivery. You can modify the delivery fields, view the demand lines and shipping containers that are currently assigned to the delivery, add or remove demand lines and shipping containers, consolidate deliveries, and do freight processing.

- The Packages page enables you to view existing packages that are part of a delivery or enter new packages. This page is accessed from the Manage Delivery page.

The Delivery Management Workbench can be accessed by:

- Selecting the Delivery Workbench link on the Shipping/Issues component in PeopleSoft Inventory.
- Navigating directly to the Delivery Management Workbench using the PeopleSoft menu (Inventory, Fulfill Stock Orders, Delivery Management Workbench).

Pages Used for the Delivery Management Workbench

Page Name	Definition Name	Usage
<u>Delivery Management Workbench-Workbench Navigation Menu Page</u>	IN_DLV_WKBNCH_MENU	Use this page to access the three main pages of the Delivery Management Workbench; Deliveries page, Demand / Container Activities page, and the Manage Deliveries page.
<u>Delivery Management Workbench-Deliveries Page</u>	IN_DLV_DELIVERIES	Select one or more deliveries based on various search criteria. You can perform delivery and freight actions on one or more deliveries at once. You can consolidate deliveries or calculate freight for multiple selected deliveries, or you can choose a single delivery to perform freight calculation.
<u>Delivery Management Workbench-Demand / Container Activities Page</u>	IN_DLV_DEMAND	Search for unassigned demand lines or shipping containers to assign to existing deliveries or to create a new delivery using the demand information to create the delivery.
<u>Delivery Management Workbench-Manage Delivery Page</u>	IN_DLV_WORKBENCH	Update one individual delivery or create a new delivery. You can modify the delivery fields, view the demand lines and shipping containers that are currently assigned to the delivery, add or remove demand lines and shipping containers, consolidate deliveries, and do freight processing.
<u>Delivery Management Workbench-Demand / Container Selection Page</u>	IN_DLV_DMDSRCH_SP	Enter search criteria, search, and select demand lines and shipping containers that you want to display in the Unassigned to Delivery group box of the Delivery Management Workbench-Manage Delivery page. These demand lines and shipping containers can be added to an existing or new delivery.

Page Name	Definition Name	Usage
Delivery Management Workbench-Packages Page	IN_DLV_PACKAGES_SP	View existing packages that are part of a delivery or enter new packages.
Delivery Management Workbench-Message / Error Log Page	IN_DLV_ERRORS_SP	View recent third-party transaction errors for the selected deliveries.

Common Elements Used in This Section

Field or Control	Description
Delivery ID	Enter a value to limit your search results to one delivery and the demand lines in that delivery.
Source	<p>Limit your search results by the PeopleSoft application where the demand lines originated. Search results include the demand lines or deliveries containing the demand lines that meet this search criteria. The options are:</p> <ul style="list-style-type: none"> • <i>IN</i>: Material stock requests created in PeopleSoft Inventory. • <i>OM</i>: Sales orders created in PeopleSoft Order Management. • <i>Non-OM</i>: Includes all sources except sales orders created in PeopleSoft Order Management. • <i>PL</i>: Material stock requests created from planning requisitions from PeopleSoft Supply Planning. • <i>PO</i>: Material stock requests created from demand in PeopleSoft Purchasing • <i>PR</i>: Material stock requests created from requisitions in PeopleSoft Purchasing. • <i>RT</i>: Material stock request created for return-to-vendor (RTV) transactions.
Src BU	Enter the business unit where the demand lines originated. For sales orders, this is the PeopleSoft Order Management business unit. For material stock requests, this is the PeopleSoft Inventory business unit.
Delivery Status	<p>Limit your search results by the status of the delivery in the IN_DELIVERY table. Search results include the deliveries or demand lines within the deliveries that have this delivery status.</p> <p>See Using PeopleSoft Tables to Store Delivery and Freight Information.</p>

Field or Control	Description
Order Number	Limit your search results to a single order number entered in this field. The order can be a sales order from PeopleSoft Order Management or a material stock request from PeopleSoft Inventory. Search results include the demand lines or deliveries containing the demand lines that meet this search criteria.
Line and To	Limit your search results to one order line or a range of order lines within the order specified in the Order Number field.
Select by Date	<p>Limit your search results based on a date contained in the order demand line. Search results include the demand lines or deliveries containing the demand lines that meet this search criteria. Values are:</p> <ul style="list-style-type: none"> • <i>Order Date</i>: Select demand lines based on the order date. Enter a date range in the <i>Date From</i> and <i>To</i> fields. For just one specific date, use the <i>Date From</i> field only. • <i>Orders Placed Today</i>: Select demand lines entered in the system today. • <i>Schedule Date</i>: Select demand lines based on a the scheduled shipment date. Enter a date range in the <i>Date From</i> and <i>To</i> fields. For just one specific date, use the <i>Date From</i> field only. • <i>Ship Early Date</i>: Select demand lines based on the Earliest Ship Date field. Enter a date range in the Date From and To fields. For just one specific date, use the Date From field only.
Date From and To	Enter the dates to retrieve demand lines. This is based on the entry in the Select by Date field.
Ship ID	Enter the shipping ID to select orders using a previously assigned shipping ID. Search results include the demand lines or deliveries containing the demand lines that meet this search criteria.
Carrier ID	Limit your search results based on one specific carrier. Search results include the demand lines or deliveries containing the demand lines that meet this search criteria.
Include Blank Carrier	Select this check box to include deliveries or demand lines without a carrier ID in your search results.

Field or Control	Description
Load ID	Enter to select demand lines assigned to a single load ID. Search results include the demand lines or deliveries containing the demand lines that meet this search criteria.
Ship Via	Enter to select demand lines or deliveries using this one shipping method.
Include Blank ShipVia	Select this check box to include deliveries or demand lines without a Ship Via code in your search results.
Route Code	Enter to select demand lines that have been grouped together for a single transportation route. Search results include the demand lines or deliveries containing the demand lines that meet this search criteria.
Ship Container ID	Enter to select demand lines assigned to a single shipping container. Search results include the demand lines or deliveries containing the demand lines that meet this search criteria.
Customer ID	Enter to select orders that were entered for a particular customer. Search results include the demand lines or deliveries containing the demand lines that meet this search criteria.
Location	Enter to select orders that were entered for a particular location code. Location codes represent the business unit's address, a branch office, or shipping office. Location codes are defined on the Location Definition page (Set Up Financials/Supply Chain, Common Definitions, Location, Location). Search results include the demand lines or deliveries containing the demand lines that meet this search criteria.
Pro Number	Limit your search results based on one pro number.
Ship To and Address Seq	Select demand lines using a Ship To Customer ID and customer address sequence number. Search results include the demand lines or deliveries containing the demand lines that meet this search criteria.
Country and State	Limit your search results based on the country or state/province. Search results include the demand lines or deliveries containing the demand lines that meet this search criteria.

Field or Control	Description
Select Freight Status	<p>Limit your search results based on the freight and manifest status of the delivery. Search results include the deliveries or demand lines within the deliveries that have this status. The Freight Status field and the Manifest Status field in the IN_DELIVERY table determine the current state of the freighting and manifesting process. Options include:</p> <ul style="list-style-type: none"> • <i>Not Started:</i> No transaction request has been sent to the third-party freight system. • <i>Rate Requested:</i> A freight rate request without a manifest action has been sent to the third-party freight provider system. • <i>Rate Received:</i> The third-party freight provider has responded to the freight request and the delivery has been updated. • <i>Manifest Requested:</i> A shipment request for freight rates and manifesting has been sent to the third-party freight provider system. • <i>Manifest Received:</i> The shipment response was received from the third-party freight provider system.
Commit Freight for Billing	<p>Select <i>Yes</i> or <i>No</i> to select deliveries with this value in the Commit Freight for Billing field of the IN_DELIVERY table. Search results include the deliveries or demand lines within the deliveries that have this status. A <i>Yes</i> value in this field indicates that the freight on this delivery is ready to be processed or has been processed by PeopleSoft Billing and by PeopleSoft Cost Management.</p>
Pick Batch ID	<p>Enter to select demand lines by the pick batch ID assigned by the Order Release process in PeopleSoft Inventory. Search results include the demand lines or deliveries containing the demand lines that meet this search criteria.</p>
Line and To	<p>Enter to select demand lines by the pick line number within a pick batch ID or a range of line numbers.</p>
Fulfillment State	<p>Choose the demand fulfillment states of the demand lines to be selected. Search results include the demand lines or deliveries containing the demand lines that meet this search criteria.</p>

Field or Control	Description
Priority and To	<p>Limit your search results based on the shipping priority code or range of codes that are assigned to sales orders in PeopleSoft Order Management. Search results include the demand lines or deliveries containing the demand lines that meet this search criteria.</p> <hr/> <p>Note: Within PeopleSoft, this field is only relevant for sales orders or interunit transfers created from PeopleSoft Supply Planning. However, the field is always available for entry to support modifications and third-party integration.</p>
Item ID	Limit your search results to demand lines containing one specific item ID. Search results include the demand lines or deliveries containing the demand lines that meet this search criteria.
Item Group	Limit your search results to demand lines containing items within one specific item group. Search results include the demand lines or deliveries containing the demand lines that meet this search criteria.
Product ID	Limit your search results to demand lines containing one specific product ID. Search results include the demand lines or deliveries containing the demand lines that meet this search criteria.
Parent Product ID	Select demand lines by the parent ID of a product kit from PeopleSoft Order Management. Search results include the demand lines or deliveries containing the demand lines that meet this search criteria.
Commodity Code	Limit your search criteria to demand lines or deliveries containing one specific commodity code. Commodity codes, also called freight classes, are used on bills of lading to group and identify shipped products for freight rating and insurance purposes.
Backorders	Select <i>Yes</i> to select demand lines that have been backordered. Select <i>No</i> to select lines that are not backordered. Leave this field blank to select both. Search results include the demand lines or deliveries containing the demand lines that meet this search criteria.
Harmonized Code	Limit your search criteria to demand lines or deliveries containing one specific harmonized tariff code. These codes are required on various documents that accompany shipments across international borders. The codes are established for all commodities by the United States Commerce Department.

Field or Control	Description
Export	Select <i>Yes</i> to retrieve demand lines with the value of <i>Yes</i> in the Export field. Select <i>No</i> to retrieve demand lines with the value of <i>No</i> in the Export field.

Delivery Management Workbench- Workbench Navigation Menu Page

Use the Delivery Management Workbench- Workbench Navigation Menu page (IN_DLV_WKBNCH_MENU) to use this page to access the three main pages of the Delivery Management Workbench; Deliveries page, Demand / Container Activities page, and the Manage Deliveries page.

Navigation:

- **Inventory > Fulfill Stock Orders > Delivery Management Workbench**
- Click the Return to Menu link at the top of any page in the Delivery Management Workbench.
- **Inventory > Fulfill Stock Orders > Shipping > Shipping/Issues > Order Summary.** Select the Delivery Workbench link before a Ship ID has been assigned.

This example illustrates the fields and controls on the The Delivery Management Workbench- Workbench Navigation Menu page. You can find definitions for the fields and controls later on this page.

Delivery Management Workbench

Workbench Navigation Menu

*Business Unit  US001 NEW YORK OPERATIONS

Delivery Activities	Demand / Container Activities	Manage Delivery
Basic Search Advanced Search	Basic Search Advanced Search	Add a Delivery Update a Delivery

The navigation menu page is the first page displayed in the Delivery Management Workbench. From this page in the workbench, the user can go to the three main pages of the workbench:

- Delivery Management Workbench-Deliveries page
- Delivery Management Workbench-Demand / Container Activities page
- Delivery Management Workbench-Manage Delivery page

<i>Field or Control</i>	<i>Description</i>
Business Unit	Enter the PeopleSoft Inventory business unit.

Delivery Activities group box

Use the Delivery Activities group box to access the Delivery Management Workbench-Deliveries page. Choose to access the basic search criteria fields or the advanced search criteria fields of the Delivery Management Workbench-Deliveries page by clicking the **Basic Search** link or the **Advanced Search** link. Use the Delivery Management Workbench-Deliveries page to search for multiple deliveries and view all deliveries selected at a summary level. You can perform delivery and freight actions on one or more deliveries at once. You can consolidate deliveries or calculate freight for multiple selected deliveries, or you can choose a single delivery to perform freight calculation.

Demand / Container Activities group box

Use the Demand / Container Activities group box to access the Delivery Management Workbench-Demand / Container Activities page. Choose to access the basic search criteria fields or the advanced search criteria fields of the Delivery Management Workbench-Demand / Container Activities page by clicking the **Basic Search** link or the **Advanced Search** link. The Demand / Container Activities page enables you to assign demand lines or shipping containers to an existing delivery or create a new delivery to hold them. You can also remove demand lines and shipping containers from a delivery and consolidate deliveries.

Manage Delivery group box

Use the Manage Delivery group box to access the Delivery Management Workbench-Manage Delivery page where you can add or update one individual delivery. Select **Update Delivery** to enter this page in update mode and maintain an existing delivery ID. Select the **Add Delivery** to enter this page in add mode where you can create new delivery. You can modify the delivery fields, view the demand lines and shipping containers that are currently assigned to the delivery, add or remove demand lines and shipping containers, consolidate deliveries, and do freight processing.

Delivery Management Workbench-Deliveries Page

Use the Delivery Management Workbench-Deliveries page (IN_DLV_DELIVERIES) to select one or more deliveries based on various search criteria.

You can perform delivery and freight actions on one or more deliveries at once. You can consolidate deliveries or calculate freight for multiple selected deliveries, or you can choose a single delivery to perform freight calculation.

Navigation:

- **Inventory > Fulfill Stock Orders > Delivery Management Workbench > Delivery Activities-Basic Search**
- **Inventory > Fulfill Stock Orders > Delivery Management Workbench > Delivery Activities-Advanced Search**
- Click the Deliveries link at the top of any page in the Delivery Management Workbench.

- **Inventory > Fulfill Stock Orders > Shipping > Shipping/Issues > Order Summary.** If multiple deliveries are on the shipped lines, select the Delivery Workbench link.

This example illustrates the fields and controls on the The Delivery Management Workbench-Deliveries page. You can find definitions for the fields and controls later on this page.

The screenshot displays the 'Deliveries' page in the Delivery Management Workbench. At the top, it shows the unit 'US001 US001 NEW YORK OPERATIONS' and navigation links like 'Manage Delivery', 'Demand / Container Activities', and 'Return to Menu'. Below this is the 'Deliveries Selection Criteria' section with various search filters including Delivery ID, *Source (set to 'All Non-OM'), Src BU (set to 'US001'), Ship ID, Order No, Date From/To, and Carrier ID. There are also checkboxes for 'Include Blank Carrier' and 'Include Blank ShipVia'. Three status selection panels are present: 'Select Delivery Status' (Open, Closed, Completed, Cancelled, Unassigned), 'Select Freight Status' (Not Started, Rate Requested, Rate Received, Manifest Requested, Manifest Received, Committed for Billing), and 'Select Fulfillment State' (Unfulfilled, Released, Confirmed, Shipped, Pending). Search and Clear buttons are provided. Below the search criteria is the 'Select for Processing' section with a 'Delivery Action' dropdown set to 'Consolidate Deliveries'. At the bottom, a table titled 'Deliveries' is shown with columns: Sel, Status, Delivery Error, Freight Status, Freight Error, Carrier ID, Ship Via, Ship To, Location, Sched Ship, Load ID, and Route. The table currently shows one row with 'Open' status.

The Deliveries page of the Delivery Management Workbench is where you can select one or more deliveries based on various search criteria. Use this page to:

- View the list of deliveries based on the results of the search. You can view delivery level information, including freight information, in a grid format.
- Perform delivery and freight actions on one or more deliveries at once.
- Consolidate deliveries.
- Calculate freight for multiple deliveries at one time.
- Choose a single delivery to perform freight calculations.

Field or Control	Description
Manage Delivery	Select this link to access the Delivery Management Workbench-Manage Delivery page where you can work with one individual delivery or create a new delivery.
Demand / Container Activities	Select this link to access the Delivery Management Workbench-Demand / Container Activities page where you can view unassigned demand lines and unassigned shipping containers.

Field or Control	Description
Return to Menu	Select this link to access the Delivery Management Workbench- Workbench Navigation Menu page where you can change the PeopleSoft Inventory business unit field for the workbench and access the three main pages of the workbench.
Advanced Search	<p>Click this link to display the extended list of search criteria fields in the Deliveries Selection Criteria group box. These search criteria help you find the deliveries to be displayed in the Select for Processing group box.</p> <p>For a complete list of the search criteria field definitions, see the <i>Common Elements Used in This Section</i> within the Using the Delivery Management Workbench section.</p> <p>See Common Elements Used in This Section.</p>
Basic Search	<p>Click this link to display the basic search criteria fields in the Deliveries Selection Criteria group box. These search criteria help you find the deliveries to be displayed in the Select for Processing group box.</p> <p>For a complete list of the search criteria field definitions, see the <i>Common Elements Used in This Section</i> within the Using the Delivery Management Workbench section.</p> <p>See Common Elements Used in This Section.</p>
Search	Click this button to initiate a search for deliveries. The system retrieves the deliveries that are associated to demand lines that match your search criteria. To re-display the search dialog after your initial search, expand the <i>Deliveries Search Criteria</i> group box.
Clear	Click this button to erase all values in the search criteria fields so that you can create enter new criteria.

Select for Processing group box

The Select for Processing group box displays the delivery IDs that meet your selection criteria based on either the basic search or the advanced search. Use this group box to view the available deliveries and select one or more deliveries for a delivery action or freight calculation. One delivery is displayed per line in the grid. This group box contains two tabs; **Shipping Info** and **Freight Data**. On the Shipping Info tab, the system displays general shipping information for the delivery such as carrier ID and scheduled ship date. On the Freight Data tab, the system displays any existing freight charge and other freight information for each delivery.

Field or Control	Description
Calculate Freight	Select one or more deliveries and click the Calculate Freight link to calculate freight for those deliveries. If the freight calculation method for the delivery is <i>internal</i> , the system performs the PeopleSoft internal freight calculation and assigns the freight amount to the delivery. If the freight calculation method for the delivery is <i>external</i> , the system transfers you to the Freight Management page where you can select freight processing options and initiate a transaction request to the external third-party freight system.
Auto-Freight	Click this button to have the system perform best-way freight calculation for externally-freighted deliveries and perform the internal freight calculation for internally-freighted deliveries. The freight is assigned to the delivery depending on the freight calculation performed. If there is a freight error, you are taken to the Freight Results page.
Delivery Action	Perform a delivery action by selecting one or more deliveries, entering a value in this field, and clicking the Save button. The delivery actions are: <ul style="list-style-type: none"> • <i>Consolidate Deliveries</i>: The system combines the selected deliveries based on the delivery key fields defined on the Inventory Definition - Business Unit Options: Delivery Management page. • <i>Reverse Freight</i>: The system reverses the post-ship actions for the deliveries, including clearing out any tracking numbers and freight amounts. Certain restrictions apply when attempting to reverse the <i>Complete Deliveries</i> and <i>Commit Freight for Billing</i> post-ship actions. If any demand lines for the delivery have already been depleted, the complete deliveries post-ship action cannot be reversed. If any freight amount for the delivery has already been sent to PeopleSoft Billing, the commit freight for billing post-ship action cannot be reversed.
Message Log	Click to access the Delivery Management Workbench-Message / Error Log page where you can view errors from delivery creation routines generated when this page is saved. This link displays only if there are errors to be viewed.
	Select the Clear icon to erase any errors on the Delivery Management Workbench- Message / Error Log page.

<i>Field or Control</i>	<i>Description</i>
Delivery ID	Click the Delivery ID link to access the Delivery Management Workbench-Manage Delivery page where you can view and update the detail of this single delivery.

Delivery Management Workbench-Demand / Container Activities Page

Use the Delivery Management Workbench-Demand / Container Activities page (IN_DLV_DEMAND) to search for unassigned demand lines or shipping containers to assign to existing deliveries or to create a new delivery using the demand information to create the delivery.

Navigation:

- **Inventory > Fulfill Stock Orders > Delivery Management Workbench > Demand / Container Activities -Basic Search**
- **Inventory > Fulfill Stock Orders > Delivery Management Workbench > Demand / Container Activities -Advanced Search**
- Click the Demand / Container Activities link at the top of any page in the Delivery Management Workbench.
- **Inventory > Fulfill Stock Orders > Shipping > Shipping/Issues > Order Summary.** Select the Delivery Workbench link after a Ship ID has been assigned.
- **Inventory > Fulfill Stock Orders > Shipping > Shipping/Issues > Order Summary.** Select the Delivery Workbench freight option and do not validate the delivery, then save the page.

This example illustrates the fields and controls on the The Delivery Management Workbench-Demand / Container Activities page . You can find definitions for the fields and controls later on this page.

The Demand / Container Activities page of the Delivery Management Workbench is where you can search for demand lines and shipping containers. Use this page to:

- Add unassigned demand lines and unassigned shipping containers to an existing delivery.
- Create a new deliver to hold the demand lines and shipping containers that you have selected on this page.
- Remove demand lines or shipping containers from an existing delivery.
- Consolidate deliveries.

Field or Control	Description
Manage Delivery	Select this link to access the Delivery Management Workbench-Manage Delivery page where you can work with one individual delivery or create a new delivery.
Deliveries	Select this link to access the Delivery Management Workbench-Deliveries page where you can work with one or more deliveries.

Field or Control	Description
Return to Menu	Select this link to access the Delivery Management Workbench- Workbench Navigation Menu page where you can change the PeopleSoft Inventory business unit field for the workbench and access the three main pages of the workbench.
Advanced Search	<p>Click this link to display the extended list of search criteria fields for this page. These search criteria help you find the demand lines and shipping containers to be displayed in the Select for Processing group box.</p> <p>For a complete list of the search criteria field definitions, see the <i>Common Elements Used in This Section</i> within the Using the Delivery Management Workbench section.</p> <p>See Common Elements Used in This Section.</p>
Basic Search	<p>Click this link to display the basic search criteria fields for this page. These search criteria help you find the demand lines and shipping containers to be displayed in the Select for Processing group box.</p> <p>For a complete list of the search criteria field definitions, see the <i>Common Elements Used in This Section</i> within the Using the Delivery Management Workbench section.</p> <p>See Common Elements Used in This Section.</p>
Search	Click this button to initiate a search for demand lines and shipping containers. The system retrieves the shipping containers that are associated to demand lines that match your search criteria. To re-display the search dialog after your initial search, expand the <i>Demand/Container Search Criteria</i> group box.
Clear	Click this button to erase all values in the search criteria fields so that you can create enter new criteria.

Select for Processing group box

The Select for Processing group box displays the demand lines and shipping containers that meet your selection criteria based on either the basic search or the advanced search. The demand lines and shipping containers are displayed in two separate grids on this page.

Field or Control	Description
Demand Action	<p>Perform a delivery action by selecting one or more demand lines or shipping containers, entering a value in this field, and clicking the Save button. Once you have saved the page, you are transferred to the Delivery Management Workbench-Deliveries page where you can view the new or altered deliveries. The demand actions are:</p> <ul style="list-style-type: none"> • <i>Assign and Consolidate:</i> The system assigns the selected demand lines and shipping containers to existing deliveries or to new deliveries as necessary and consolidates deliveries according to the delivery key configuration defined for the PeopleSoft Inventory business unit. • <i>Assign to Existing Delivery:</i> The system assigns the selected demand lines and shipping containers to existing delivery IDs matching the demand values to the delivery according the delivery key configuration defined for the PeopleSoft Inventory business unit. • <i>Create Deliveries:</i> The system creates new deliveries for the selected demand lines and shipping containers according to the delivery key configuration for the PeopleSoft Inventory business unit. • <i>Remove from Delivery:</i> The system removes the selected demand lines and shipping containers from their assigned deliveries.
Message Log	<p>Click to access the Delivery Management Workbench-Message / Error Log page where you can view errors from delivery creation routines generated when this page is saved. This link displays only if there are errors to be viewed.</p>
	<p>Select the Clear icon to erase any errors on the Delivery Management Workbench- Message / Error Log page.</p>

Field or Control	Description
Demand Lines	The Demand Lines group box displays independent demand lines that match the search criteria. The Demand Data tab shows relevant information about the demand line, including; Ship To customer ID, item ID, and item description. If a demand line is already assigned to a delivery, then the Delivery ID is displayed; click the Delivery ID link to access the Delivery Management Workbench- Manage Delivery page where you can view the details of this delivery. Click the Order Key link to access the Stock Request inquiry page where you can view the details for this demand line and each demand line in the order. The Shipping Info tab shows the carrier ID, ship via code, scheduled ship date, and the current fulfillment state for the demand line.
Shipping Containers	The Shipping Containers group box displays shipping containers that contain demand lines matching your search criteria. The Container Data tab displays relevant container information like container dimensions, Ship To customer ID, and Ship To location. If a shipping container is already assigned to a delivery, then the Delivery ID is displayed; click the Delivery ID link to access the Delivery Management Workbench- Manage Delivery page where you can view the details of this delivery. On the Shipping Info tab, the system displays general shipping and freight information for the container such as carrier ID, ship via code, scheduled ship date, freight amount, and tracking number.

Delivery Management Workbench-Manage Delivery Page

Use the Delivery Management Workbench-Manage Delivery page (IN_DLV_WORKBENCH) to update one individual delivery or create a new delivery.

You can modify the delivery fields, view the demand lines and shipping containers that are currently assigned to the delivery, add or remove demand lines and shipping containers, consolidate deliveries, and do freight processing.

Navigation:

- **Inventory > Fulfill Stock Orders > Delivery Management Workbench > Manage Delivery-Add a Delivery**
- **Inventory > Fulfill Stock Orders > Delivery Management Workbench > Manage Delivery-Update a Delivery**
- Click the Manage Delivery link at the top of any page in the Delivery Management Workbench.
- From the Delivery Management Workbench-Deliveries page, click the Delivery ID link.

- From the Delivery Management Workbench- Demand / Container Activities page, click the Delivery ID link on demand lines or shipping containers already assigned to deliveries.
- **Inventory > Fulfill Stock Orders > Shipping > Shipping/Issues > Order Summary.** If one delivery for all the shipped lines, select the Delivery Workbench link.

This example illustrates the fields and controls on the The Delivery Management Workbench-Manage Delivery page (part 1 of 3).

Delivery Management Workbench

Manage Delivery [Deliveries](#)
[Demand / Container Activities](#)
[Return to Menu](#)

Unit US001 US001 NEW YORK OPERATIONS Update a Delivery

Delivery ID 🔍 📄

Sched Ship 🔍 📅

Carrier ID 🔍

Load ID

Ship To Loc

Location

Delivery restricted to order

Status ▼

Use Preferred Freight Carrier

[Manage Loads](#)

[Packing Session](#)

Freight

Freight Rate Status ▼

Manifest Status ▼

Freight Committed for Billing

Freight Amount

Freight Charge Override

Freight Rollup ▼

Freight Overrides

Freight Terms

Freight Charge Method ▼

Freight Type Code 🔍

Frt Svc Defn 🔍

Freight Ref Num

Pro Number

This example illustrates the fields and controls on the The Delivery Management Workbench-Manage Delivery page (part 2 of 3).

More Delivery Data

Customer Name

Country

Address 1

Address 2

Address 3

City

County Postal

State

Item ID <input type="text"/>	Item Group <input type="text"/>	*Product <input type="text"/>
Order No	Load Stop	VAT Entity
Commodity Code <input type="text"/>		Communicated Arrival Datetime <input type="text"/>
Harmonized Code <input type="text"/>		Communicated Ship Datetime <input type="text"/>

Override Weight <input type="text"/>	Override Volume <input type="text"/>	Total Pieces <input type="text"/>
Total Weight 0.0000	Total Volume 0.0000	Total Pkgs 0
Max Weight 0.0000	Max Volume 0.0000	Total Containers 0

This example illustrates the fields and controls on the The Delivery Management Workbench-Manage Delivery page (part 3 of 3). You can find definitions for the fields and controls later on this page.

The screenshot displays two main sections: 'Assigned to Delivery' and 'Unassigned to Delivery'. Each section contains a table with the following columns: Sel, Delivery ID, Status, Source Key, and State. The 'Assigned to Delivery' section has a 'Remove from Delivery' button and a 'Validate Delivery' button. The 'Unassigned to Delivery' section has an 'Add to Delivery' button and a 'Get Demand Lines / Containers' button. Both sections also feature a 'Select Lines to...' header, a 'Personalize | Find | View All' menu, and pagination controls showing 'First 1 of 1 Last'.

The Manage Delivery page of the Delivery Management Workbench provides a place where you can view and update detailed information for a single delivery. Use this page to:

- Add a new delivery.
- Modify an existing delivery.
- View the demand lines and shipping containers that are currently assigned to the delivery.
- Add or remove demand lines and shipping containers from the delivery.
- Consolidate deliveries.
- Perform freight processing.
- Access the Package page of the Delivery Management Workbench where you can enter detailed information about packages on the delivery.

If creating a new delivery, you have the opportunity to enter values for the delivery level information on this page depending on the delivery key fields defined on the Inventory Definition - Business Unit Options: Delivery Management page. For a new delivery, you can enter the carrier ID, scheduled ship date, and values for any other fields that are selected with the Allow New Entry in Workbench check box on the Inventory Definition-Business Unit Options: Delivery Management page. Alternatively, you can start by selecting demand lines or shipping containers to be assigned to the delivery; assigning demand or shipping containers automatically sets the delivery key values for the new delivery.

If displaying an existing delivery, demand lines and shipping containers are displayed in two separate group boxes on this page. The first group box, **Assigned to Delivery**, displays demand lines and shipping containers already assigned to the delivery. The second group box, **Unassigned to Delivery**, displays unassigned demand lines or shipping containers that were retrieved from your search criteria.

Field or Control	Description
Add a Delivery	Click this button to add a new delivery using this page. This button is available when the page is in the <i>Update a Delivery</i> mode.
Update a Delivery	Click this button to work with an existing delivery on this page. This button is available when the page is in the <i>Add a Delivery</i> mode.
Deliveries	Select this link to access the Delivery Management Workbench- Deliveries page where you can work with one or more deliveries.
Demand / Container Activities	Select this link to access the Delivery Management Workbench- Demand / Container Activities page where you can view demand lines and shipping containers.
Return to Menu	Select this link to access the Delivery Management Workbench- Workbench Navigation Menu page where you can change the PeopleSoft Inventory business unit field for the workbench and access the three main pages of the workbench.
Delivery ID	Select an existing delivery that you want to view, change, or perform freight calculations. The information on this page relates to only one delivery. This field displays the value of <i>NEXT</i> when creating a new delivery that has not yet been saved. For a new delivery, you can manually enter a delivery ID and the system verifies that it is unique when you save the page.
Sched Ship	Change or view the scheduled shipment date for this delivery.
Delivery Status	Displays the current status of this delivery. Using this field, the status can be changed. For details on each delivery status, see the delivery status field in the IN_DELIVERY table defined in the Setting Up Delivery Management and Freight Calculations topic. See Using PeopleSoft Tables to Store Delivery and Freight Information .
Ship Via	Change or view the Ship Via field for this delivery. Use caution when changing this field on an existing delivery since it is often defined as a delivery key fields (Inventory Definition - Business Unit Options: Delivery Management page).
Carrier ID	Change or view the carrier for this delivery. This field can be blank if you want the external third-party freight system to determine the best carrier for this delivery.

Field or Control	Description
Use Preferred Freight Carrier	Select to indicate that the customer prefers a particular carrier. The values in the Use Preferred Freight Carrier field and the Carrier ID field may have defaulted from the Order Management default hierarchy (Order Groups page, the customer's General Information - Ship To Options page, Buying Agreement Form-Header Terms page, or manually entered on the sales order).
Route Code	View the route code assigned to this delivery.
Load ID	View the load ID for this delivery.
Manage Loads	Click to access the Manage Loads page where you can review or create shipment loads for orders. You can assign demand lines to newly created loads or you can define the load parameters and then make the actual assignments at other points in the fulfillment process. See "Managing Loads" (PeopleSoft Inventory).
Ship To and Ship To Loc	View the Ship To Customer ID and Ship To Location (customer address sequence number) assigned to this delivery.
Packing Session	Click to access the Packing Session component where you can: <ul style="list-style-type: none"> Place demand lines into new or existing shipping containers. Override freight amounts. Override weight and volume for shipping containers. See "Packing Stock Into Shipping Containers" (PeopleSoft Inventory).
Location	Enter to select orders that were entered for a particular location code. Location codes represent the business unit's address, a branch office, or shipping office. Location codes are defined on the Location Definition page (Set Up Financials/Supply Chain, Common Definitions, Location, Location). Search results include the demand lines or deliveries containing the demand lines that meet this search criteria.
Deliveries restricted to order	Select this check box to restrict the demand lines of this delivery to only one sales order.
Maintain Packages	Click this link to access the Packages page of the Delivery Management Workbench where you can review existing packages that are part of this delivery or enter new packages. See Delivery Management Workbench- Packages Page .

Freight group box

You can override and manually enter freight amount and other freight information in the freight group box.

Field or Control	Description
Freight Rate Status	<p>Displays the current state of the freight process from the Freight Status field in the IN_DELIVERY table. The options are:</p> <ul style="list-style-type: none"> • <i>None</i>: No communication to the third-party freight provider system. • <i>Requested</i>: A freight rate request has been sent to the third-party freight provider system. You can change this status to <i>None</i> when cancelling a freight request. • <i>Received</i>: The third-party freight provider has responded to the freight request and the delivery has been updated.
Freight Amount	<p>Displays the current freight amount assigned to this delivery. This value can be manually overridden. If a manual entry is made in this field, then the Freight Charge Override check box is automatically selected.</p>
Calculate Freight	<p>Click the Calculate Freight link to calculate freight for this delivery. If the freight calculation method for the delivery is <i>internal</i>, the system performs the PeopleSoft internal freight calculation and assign the freight amount to the delivery. If the freight calculation method for the delivery is <i>external</i>, the system transfers you to the <i>Freight Management</i> page where you can select freight processing options and initiate a transaction request to the external third-party freight system.</p>
Manifest Status	<p>Displays the current state of the manifest process from the Manifest Status field in the IN_DELIVERY table. The options are:</p> <ul style="list-style-type: none"> • <i>None</i>: Manifest process not performed by the third-party freight provider system. • <i>Requested</i>: A freight rate request and a manifest action has been sent to the third-party freight provider system. You can change this status to <i>None</i> when cancelling a request. • <i>Received</i>: The third-party freight provider has responded to the freight request and manifest action. The delivery has been updated.

Field or Control	Description
Freight Charge Override	<p>Select this check box to use the value entered in the Freight Amount field as an override. The freight routines do not change your override freight amount.</p> <hr/> <p>Note: The inbound EIP transactions do not update your freight amount when this check box is selected.</p> <hr/>
Auto-Freight	<p>Click this button to have the system perform best-way freight calculation for an externally-freighted delivery and perform the internal freight calculation for an internally-freighted delivery. The freight is assigned to the delivery depending on the freight calculation performed.</p>
Freight Committed for Billing	<p>Select this check box to indicate that the freight on this delivery is ready to be processed by PeopleSoft Billing and by PeopleSoft Cost Management. If this check box has already been checked then the freight on this delivery is ready to be processed or has been processed by PeopleSoft Billing and Cost Management. This check box sets the value in the Commit Freight for Billing field of the IN_DELIVERY table.</p>

Field or Control	Description
Freight Rollup	<p>Select an option to determine which freight amounts to be used. This option applies to both internal and external freight calculations as well as to manual freight entered at the package or shipping container levels. Freight amounts can be received from the external third-party freight system at the delivery-level or at a lower-level. The options are:</p> <ul style="list-style-type: none"> • <i>Delivery</i>: Receive the delivery-level freight amounts from the external third-party freight system or the internal PeopleSoft freight calculator. This amount is stored at the delivery level in the PeopleSoft delivery ID. For the internal PeopleSoft freight calculator you must select this option since the internal system only calculates freight at the delivery level. • <i>Rollup</i>: Receive the freight amounts from the external third-party freight system that are stored at the package or shipping container levels. You could manually enter freight amounts at the package or container level. The PeopleSoft system combines all of the freight amounts for every package and shipping container within the delivery and stores the total at the delivery level in the PeopleSoft delivery ID. <p>Depending on your external third-party freight system, freight amounts could be received at the delivery-level, shipping container level, package level, or all levels.</p> <p>See Receiving Freight Charges.</p>
Reverse Freight	<p>Click this button to reverse the post-ship actions for the delivery, including clearing out any tracking numbers and freight amounts. Certain restrictions apply when attempting to reverse the <i>Complete Deliveries</i> and <i>Commit Freight for Billing</i> post-ship actions. If any demand lines for the delivery have already been depleted, the complete deliveries post-ship action cannot be reversed. If any freight amount for the delivery has already been sent to PeopleSoft Billing or PeopleSoft Cost Management, then the commit freight for billing post-ship action cannot be reversed.</p>

Freight Overrides group box

Click the Expand Section icon to display the Freight Overrides group box. Use this group box to change freight settings for this delivery before calculating freight.

Field or Control	Description
Freight Terms	<p>Enter a freight terms code to override the default freight terms code. This override value is applied to the entire delivery.</p> <p>The freight terms code determines whether the buyer or the seller pays the freight. If the buyer pays the freight, then freight charges are passed to PeopleSoft Billing. If the seller pays the freight, then charges do not pass to PeopleSoft Billing. Keep in mind that the Freight Bill Type field determines which freight amounts are passed to PeopleSoft Billing; the amounts calculated at order entry or the amounts calculated during shipping.</p>
Freight Charge Method	<p>Determines how freight charges, received from the external third-party freight system or the internal PeopleSoft freight calculator, are allocated to the order-level. The freight amount is initially stored at the delivery-level in the PeopleSoft delivery ID and then prorated to the order level. You have four options: Order Quantity, Order Value, Volume, and Weight.</p> <p>See Applying Freight Charges to the Order Level.</p>
Freight Type	<p>View or change the freight type code to be used by the external third-party freight system. Freight types are defined at the SetID level and are placed on the header level of the outbound message to the third-party provider. The freight type is also used to derive the correct service definition to send with the outbound message. Entering a value here helps to limit the values displayed for the Freight Service Definition field in this group box.</p> <p>For more information about freight type codes, see Setting Up External Third-Party Freight Charges.</p>

Field or Control	Description
Freight Service Definition	<p>View or override the freight service definition for this delivery.</p> <p>The freight service definition provides a way to cross-reference the third-party freight service with the PeopleSoft carrier and ship-via combinations. The Automated Service Option check box on the Setup Fulfillment- Delivery/Freight page determines if this PeopleSoft Inventory business unit uses the freight service definition with the third-party integration. Some third-party providers require it. Freight service definitions are defined at the SetID level using the Maintain Freight Services page. The freight service definition code is based on the services provided by the third-party provider. Each freight service definition is associated with a combination of carrier ID, ship via code, and freight type in the PeopleSoft system.</p> <p>See Setting Up External Third-Party Freight Charges.</p>
Freight Ref Num (freight reference number)	Enter data in this free form reference field. The value entered here is stored at the delivery level. If a freight reference number is returned on the freight response then it is stored in this field.
Pro Number	Enter a pro number to be applied as an override to the entire delivery. This entry overrides any previously entered value on an individual demand line.

More Delivery Data group box

Click the Expand Section icon to display the More Delivery Data group box. This group box displays customer address information, item and product information. In addition, this group box also enables you to override calculated weight and volume of this delivery.

Field or Control	Description
Override Weight and Override Volume	<p>If using the internal PeopleSoft freight calculator, these override fields can be used as the weight and volume for the delivery.</p> <p>If using an external third-party freight provider, these override fields are sent out to the third-party freight system at the header level of the outbound transaction. These fields can be updated by the third-party system using the inbound freight response transaction.</p>

Field or Control	Description
Total Pieces	Enter the number of pieces within the delivery. This is a memo-only field that is passed to the third-party providers system on the header level of the outbound transaction.

Assigned to Delivery group box

The Assigned to Delivery group box displays demand lines and shipping containers already assigned to the delivery.

Field or Control	Description
Remove from Delivery	Click this button to remove selected demand lines or shipping containers from this delivery.
Validate Delivery	Click this button to verify that the demand lines assigned to the delivery are valid for this delivery definition and that the demand line values correctly match the delivery values according to the delivery key configuration for this PeopleSoft Inventory business unit.
Message Log	Click to access the Delivery Management Workbench-Message / Error Log page where you can view errors from delivery creation routines generated when this page is saved. This link displays only if there are errors to be viewed.
	Select the Clear icon to erase any errors on the Delivery Management Workbench- Message / Error Log page.

Unassigned to Delivery group box

The Unassigned to Delivery group box displays demand lines and shipping containers for which you have recently searched. This grid is empty the first time you display this page, because you first have to search for demand lines or shipping containers to assign to this delivery. In this grid, you can select one or more unassigned demand lines or shipping containers and assign them to this delivery.

To assign demand lines or shipping containers to a delivery, search for the demand lines and shipping containers by clicking **Get Demand Lines / Containers** link to access the Demand / Container Selection page in the Delivery Management Workbench . Enter your search criteria and search. The demand lines and shipping containers matching your search criteria are displayed in the *Unassigned to Delivery* grid on this page. Select the demand lines or shipping containers you want to assigned and click the **Add to Delivery** button. The demand lines and shipping containers are moved to the *Assigned to Delivery* grid.

Field or Control	Description
Add to Delivery	Click this button to add the selected items to the delivery displayed on this page. This button moves the selected demand lines and shipping containers in this group box to the Assigned to Delivery group box.
Get Demand Lines / Containers	Click this link to access the Delivery Management Workbench- Demand / Container Selection page where you can enter search criteria for demand lines and shipping containers that you want to display in the Unassigned to Delivery group box.

Common Fields in the Assigned to Delivery group box and the Unassigned to Delivery group box

The following fields are located in both the Assigned to Delivery group box and the Unassigned to Delivery group box.

Field or Control	Description
Sel	Select this check box to add the row to the delivery displayed on this page. After selecting one or more rows, click the Add to Delivery button.
Delivery ID	Displays no value if the demand line or shipping container is not currently assigned to a delivery. The demand line or shipping container is in a delivery if a delivery ID is displayed in this field.
Status	Displays the status of the delivery for this demand line or shipping container. If the row is not assigned to a delivery, then the system displays the value of <i>Unassigned</i> .
Source Key	Displays the demand source and source business unit of this demand line or shipping container.
Order Key	Displays the order number, line number, shipment schedule number, and demand line number for this row. Click this link to access the Stock Request inquiry page where you can view the details for this demand line and each demand line in the order.

Field or Control	Description
Ship Cntr ID	Displays the ID for the shipping container. Click this link to access the Shipping Container Detail page where you can view the details of this container.
State	Displays the demand fulfillment state of the demand line.
Shipping Info	On the Shipping Info tab, the system displays general shipping and freight information for demand lines or shipping containers.

Delivery Management Workbench- Demand / Container Selection Page

Use the Delivery Management Workbench- Demand / Container Selection page (IN_DLV_DMDSRCH_SP) to enter search criteria, search, and select demand lines and shipping containers that you want to display in the Unassigned to Delivery group box of the Delivery Management Workbench-Manage Delivery page.

These demand lines and shipping containers can be added to an existing or new delivery.

Navigation:

Select the Get Demand Lines / Containers link on the Delivery Management Workbench-Manage Delivery page.

This example illustrates the fields and controls on the The Delivery Management Workbench- Demand / Container Selection page .

The screenshot shows the 'Demand / Container Selection' page in the Delivery Management Workbench. At the top, it displays 'Unit US001 US001 NEW YORK OPERATIONS' and navigation links like 'Manage Delivery', 'Deliveries', and 'Return to Menu'. Below this are search options: 'Advanced Search' and 'Basic Search'. The main section is titled 'Demand / Container Selection' and contains several input fields: 'Delivery ID', 'Ship ID', 'Ship Cntr ID', '*Source' (set to 'Sales Order'), 'Src BU' (set to 'US001'), 'Order No', 'Date From', 'Date To', 'Carrier ID', and 'Ship Via'. There are also checkboxes for 'Include Blank Carrier' and 'Include Blank ShipVia'. Below these are three panels for selecting status: 'Select Delivery Status' (Open, Closed, Completed, Not Assigned), 'Select Freight Status' (Not Started, Rate Requested, Rate Received, Manifest Requested, Manifest Received, Committed for Billing), and 'Select Fulfillment State' (Unfulfilled, Confirmed, Releasable, Shipped, Released, Pending). A 'Search' button and a 'Clear' button are present. The bottom section is titled 'Select for Processing' and includes a 'Demand Action' dropdown. It contains two tables: 'Demand Lines' with columns 'Sel', 'Source', 'Kit Line', 'Ship To', 'Location', 'Item ID', and 'Description'; and 'Shipping Containers' with columns 'Sel', 'Type', 'Length', 'Width', 'Height', 'Dim', 'Ship To', and 'Location'. Both tables have a 'Personalize' link and navigation controls like 'First', '1 of 1', and 'Last'.

Enter search criteria for demand lines and shipping containers that you want to display in the Unassigned to Delivery group box of the Delivery Management Workbench-Manage Delivery page. These demand lines and shipping containers can be added to an existing or new delivery.

For a complete list of the search criteria field definitions, see the *Common Elements Used in This Section* within the Using the Delivery Management Workbench section.

See Common Elements Used in This Section.

Delivery Management Workbench- Packages Page

Use the Delivery Management Workbench- Packages page (IN_DLX_PACKAGES_SP) to view existing packages that are part of a delivery or enter new packages.

Navigation:

Click the Maintain Packages link on the Delivery Management Workbench-Manage Delivery page.

This example illustrates the fields and controls on the The Delivery Management Workbench- Packages page. You can find definitions for the fields and controls later on this page.

The screenshot shows the 'Maintain Packages' page. At the top, it displays delivery information: Unit US010 PHOENIX BIKE/OUTDOOR, Delivery ID 1110000501, Total Pkg Weight 0.0000 LBS, Total Pkg Volume 0.0000 CUF, and Total Freight 0.00 USD. A 'Refresh Totals' button is visible. Below this is a 'Packages' section with tabs for 'Package Data' and 'Shipping Data'. A table lists package details with columns: Package ID, Type, Length, Width, Height, UOM, Pkg Weight, UOM, Pkg Volume, UOM, Freight Chrg, and Freight Charge Override. The first row shows Package ID 000000000000001, Type 2BO, Length 24.0000, Width 12.0000, Height 12.0000, UOM IN, Pkg Weight 30.0000, UOM LBS, Pkg Volume, UOM CUF, and Freight Chrg 0.0000. At the bottom are 'OK', 'Cancel', and 'Refresh' buttons.

The Packages page enables you to view existing packages that are part of a delivery or enter new packages. This page is accessed from the Manage Delivery page. Packages are defined either manually by the user or can be returned from the third-party freight provider. If one or more packages is assigned to a delivery, it is assumed that all loose demand for the delivery is in one of the assigned packages.

Field or Control	Description
Refresh Totals	Click this button to recalculate the following fields: Total Package Weight, Total Package Volume, and Total Freight.

Package Data tab

Field or Control	Description
Type	(optional) Enter a container type (Inventory, Maintain Containers, Container Types) to populate the dimensions of this package based on the shipping parameters of the container type.
Freight Chrg (freight charge)	View or override the current freight amount assigned to this package.
Freight Charge Override	Select this check box to use the value entered in the Freight Chrg field as an override. The freight routines do not change your override freight amount. Note: The inbound EIP transactions do not update your freight amount when this check box is selected.

<i>Field or Control</i>	<i>Description</i>
Freight Charge Override	Select this check box to use the value entered in the Freight Amount field as an override. The freight routines do not change your override freight amount. Note: The inbound EIP transactions do not update your freight amount when this check box is selected.

Shipping Data tab

<i>Field or Control</i>	<i>Description</i>
Comm Ship Date (committed shipment date)	Displays the committed shipment date returned by the third-party freight system.
Comm Arrv Date (committed arrival date)	Displays the committed arrival date returned by the third-party freight system.
Freight Ref Num (freight reference number)	Enter data in this free form reference field. If a freight reference number is returned on the freight response then it is stored in this field at the package level.
Tracking Number	Displays the tracking number for this package.

Package Label tab

<i>Field or Control</i>	<i>Description</i>
Link to Package Label	Click this link to access the third-party website where you can view and print the packing label for this package.

Delivery Management Workbench- Message / Error Log Page

Use the Delivery Management Workbench- Message / Error Log page (IN_DLV_ERRORS_SP) to view recent third-party transaction errors for the selected deliveries.

Navigation:

- **Inventory > Fulfill Stock Orders > Delivery Management Workbench > Delivery Activities-Basic Search. Click the Message Log link.**
- **Inventory > Fulfill Stock Orders > Delivery Management Workbench > Demand / Container Activities-Basic Search. Click the Message Log link.**

- **Inventory > Fulfill Stock Orders > Delivery Management Workbench > Manage Delivery-Basic Search. Click the Error Log link.**

This example illustrates the fields and controls on the The Delivery Management Workbench- Message / Error Log page.

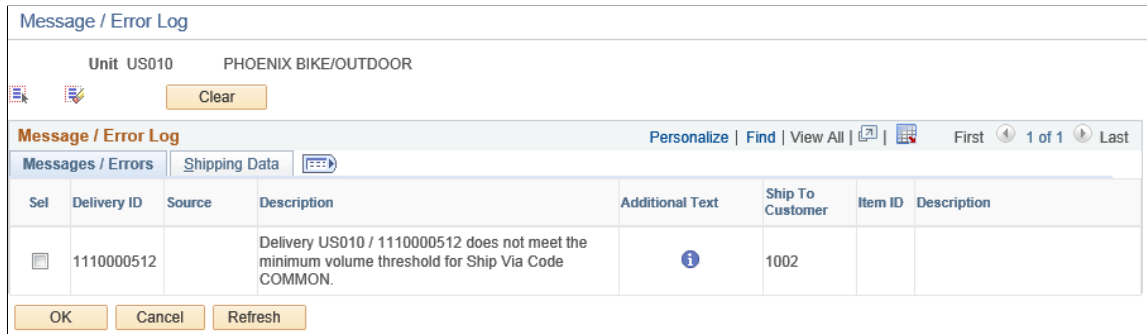

Use the Delivery Management Workbench- Message / Error Log page to view errors from delivery creation routines generated when the Delivery Management Workbench is saved.

Using the Freight Request Component

This section discusses the Freight Request component where you can set parameters and calculate freight amounts using an external third-party freight system. The Freight Request Component can be accessed by selecting the Calculate Freight button on the Order Entry Form in PeopleSoft Order Management and Delivery Management Workbench.

Pages Used for the Freight Request Component

Page Name	Definition Name	Usage
<u>Calculate Freight Page</u>	IN_FRT_MAINT	This page gives the user the option to select freight processing options for the external third-party freight request.
<u>Freight Results Page</u>	IN_FRT_RESULT_SP	View freight results sent by the external third-party freight system or view any error messages when the integration fails. This page displays information sent by the external third-party system including freight amounts, the committed shipment date and the committed arrival date. For the delivery, the freight service definition, carrier, ship via code, shipping weight, shipping volume, and the total number of pieces are also displayed.

Page Name	Definition Name	Usage
<u>Freight Results Detail Page</u>	IN_FRT_RSLT_DTL_SP	View the details of the freight results sent by the external third-party system including total freight and shipping weight for the delivery. The details of each package or shipping container are displayed including; freight amounts, shipping weights, shipping volume, dimensions, and freight reference numbers. If the integration fails, this page displays detailed information about the error message.

Calculate Freight Page

Use the Calculate Freight page (IN_FRT_MAINT) to select freight processing options for the external third-party freight request.

Navigation:

- From the Delivery Management Workbench-Deliveries page, select one or more delivery IDs and click the Calculate Freight link.
- From the Delivery Management Workbench-Manage Delivery page, click the Calculate Freight link.

Calculate Freight page

The Calculate Freight page enables you to:

- View current delivery information.
- Set parameters for the integration to the external third-party system.
- Launch either the *Inventory Freight Rate Request* EIP or the *Inventory Freight Ship Request* EIP.

Post ship actions within the Post Ship Actions group box cannot be performed until all demand lines have been shipped.

Field or Control	Description
Freight Options	<p>Select one of the following freight options to request freight from an external third-party freight system:</p> <ul style="list-style-type: none"> • <i>Shop For Rates:</i> Rate shopping enables you to preview and choose which freight carrier and charges to use on the delivery based on the choices retrieved from the third-party freight provider. This method displays the freight choices on the Freight Results page for you to view, evaluate, and select the best choice for your needs. • <i>Best Way:</i> The PeopleSoft system sends a best way request to the third-party provider system and the third-party provider returns only one freight choice per delivery ID. You can preview this choice using the Freight Results page. Use the Best Way group box to choose the best way option. The best way options are least cost or by commit date. • <i>Use Specified Carrier:</i> The PeopleSoft system sends a request with a specific carrier ID to the third-party provider system and the third-party provider returns only freight choices from the specified carrier. This method displays the freight choices on the Freight Results page for you to view, evaluate, and select the best choice. • <i>Best Way if blank carrier ID</i> Select this check box to enable the third-party freight system to return freight results when the carrier ID field is blank on a delivery that uses the <i>Use Specified Carrier</i> freight option. If the PeopleSoft system sends a delivery using the <i>Use Specified Carrier</i> freight option and the delivery does not have a carrier ID assigned to it, then the <i>Best Way</i> freight option is used.
Best Way	<p>If you have selected <i>Best Way</i> in the Freight Options group box, then use this group box to choose your best way option:</p> <ul style="list-style-type: none"> • <i>Least Cost:</i> The third-party freight system selects and returns the freight service with the least cost. • <i>By Commit Date:</i> The third-party freight system selects and returns the freight service that best matches the scheduled ship date.
External Manifest	<p>Select this check box to instruct the external third-party freight system to create or update shipping manifests for the individual carriers. Label URL references and tracking numbers for the selected deliveries, containers, and packages, is sent to the PeopleSoft system and maintained with the shipping history information. In order to use external manifest all of the demand lines in the delivery must be in the fulfillment state of Shipped. A freight option of Best Way or Use Specified Carrier must be selected to perform external manifesting.</p>

Field or Control	Description
Complete Delivery	Select this check box to set the status of the delivery to <i>Complete Delivery</i> which indicates that all fulfillment steps for the delivery are complete and all demand lines in the delivery are ready to be depleted using the Deplete On Hand Qtys process. If the PeopleSoft Inventory business unit is using deliveries, the Deplete On Hand Qtys process only pick ups demand lines that are on a delivery with the <i>Complete Delivery</i> status.
Commit Freight for Billing	Select this check box to indicate that the freight on this delivery is ready to be processed by PeopleSoft Billing and by PeopleSoft Cost Management.
Preview Freight	Click this button to send a transaction request to the external third-party freight system using the synchronous <i>Inventory Freight Rate Request</i> EIP. The third-party freight system sends freight results based on your selection in the Freight Options group box. See Receiving Freight Data from the Third-Party Freight System .
Process Freight with Post-Ship Actions	Click this button to send a transaction request to the external third-party freight system including any selected post ship actions such as external manifest. This button uses the synchronous <i>Inventory Freight Ship Request</i> EIP if you have selected the External Manifest check box on this page. If you have not selected the External Manifest check box, then this button uses the synchronous <i>Inventory Freight Rate Request</i> EIP. The third-party freight system sends freight results based on your selection in the Freight Options group box. In order to use this button, you must select a best way or specific carrier Freight Option. The system returns only one freight choice and updates the delivery with the freight information in addition to performing the selected post ship actions. See Receiving Freight Data from the Third-Party Freight System .

Deliveries Group Box

The Deliveries group box displays information about the deliveries and the results from the third-party freight system.

Field or Control	Description
Carrier ID	Displays the carrier. This field can be changed if you have selected the Use Specific Carrier freight option on this page.

Field or Control	Description
Freight Type	<p>View the freight type code used by the external third-party freight system. Freight types are defined at the SetID level and are placed on the header level of the outbound message to the third-party provider. The freight type is also used to derive the correct service definition to send with the outbound message. The freight type code helps to limit the values displayed for the Freight Service Definition field in this group box.</p> <p>For more information about freight type codes, see Setting Up External Third-Party Freight Charges.</p>
Freight Service Definition	<p>View or override the freight service definition for this delivery.</p> <p>The freight service definition provides a way to cross-reference the third-party freight service with the PeopleSoft carrier and ship-via combinations. The Automated Service Option check box on the Setup Fulfillment- Delivery/Freight page determines if this PeopleSoft Inventory business unit uses the freight service definition with the third-party integration. Some third-party providers require it. Freight service definitions are defined at the SetID level using the Maintain Freight Services page. The freight service definition code is based on the services provided by the third-party provider. Each freight service definition is associated with a combination of carrier ID, ship via code, and freight type in the PeopleSoft system.</p> <p>See Setting Up External Third-Party Freight Charges.</p>

Freight Results Page

Use the Freight Results page (IN_FRT_RESULT_SP) to view freight results sent by the external third-party freight system or view any error messages when the integration fails.

This page displays information sent by the external third-party system including freight amounts, the committed shipment date and the committed arrival date. For the delivery, the freight service definition, carrier, ship via code, shipping weight, shipping volume, and the total number of pieces are also displayed.

Navigation:

- Select one or more deliveries on the Calculate Freight page and click the Preview Freight button.
- Select the Auto-Freight button on the Delivery Management Workbench- Deliveries page. You are transferred here if you have an error.
- Select the Auto-Freight button on the Delivery Management Workbench- Manage Delivery page. You are transferred here if you have an error.

This example illustrates the fields and controls on the The Freight Results page using the rate shopping freight option. You can find definitions for the fields and controls later on this page.

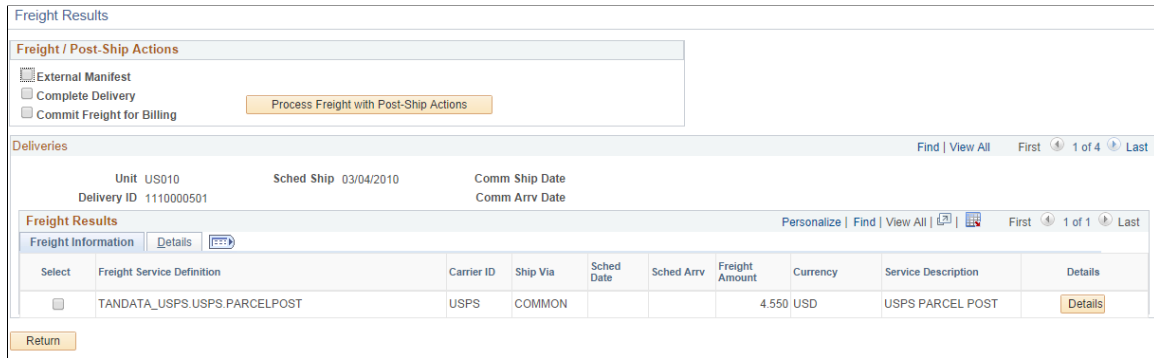

Use this page to review freight results sent by the external third-party freight system or view any error messages if the integration fails. This page displays information sent by the external third-party system including freight amounts, the committed shipment date and the committed arrival date. For the delivery, the freight service definition, carrier, ship via code, shipping weight, shipping volume, and the total number of pieces are also displayed.

If you are using the *Shop For Rates* freight option, then this page displays all freight services returned by the third-party system.

If you are using the Best Way freight option and get an error, then the page also displays all freight services returned by the third-party freight system.

Select an option and click the **Return** button.

Freight / Post-Ship Actions group box

Use the Freight / Post-Ship Actions group box to select options and launch another transaction request to the external third-party freight system using synchronous *Inventory Freight Ship Request* EIP. The Post-ship actions cannot be performed until all demand lines have been shipped or depleted.

Field or Control	Description
External Manifest	Select this check box to instruct the external third-party freight system to create or update shipping manifests for the individual carriers. Label URL references and tracking numbers for the selected deliveries, containers, and packages, are sent to the PeopleSoft system and maintained with the shipping history information. In order to use external manifest all of the demand lines in the delivery must be in the fulfillment state of Shipped. A freight option of Best Way or Use Specified Carrier must be selected to perform external manifesting.

Field or Control	Description
Complete Delivery	Select this check box to set the status of the delivery to <i>Complete Delivery</i> which indicates that all fulfillment steps for the delivery are complete and all demand lines in the delivery are ready to be depleted using the Deplete On Hand Qtys process. If the PeopleSoft Inventory business unit is using deliveries, the Deplete On Hand Qtys process only pick ups demand lines that are on a delivery with the Complete Delivery status.
Commit Freight for Billing	Select this check box to indicate that the freight on this delivery is ready to be processed by PeopleSoft Billing and by PeopleSoft Cost Management.
Process Freight with Post-Ship Actions	Click this button to send a transaction request to the external third-party freight system including any selected post ship actions such as external manifest. The third-party freight system sends freight results based on your selection in the Freight Options group box on the Freight Results page.

Freight Results Detail Page

Use the Freight Results Detail page (IN_FRT_RSLT_DTL_SP) to view the details of the freight results sent by the external third-party system including total freight and shipping weight for the delivery.

The details of each package or shipping container are displayed including; freight amounts, shipping weights, shipping volume, dimensions, and freight reference numbers. If the integration fails, this page displays detailed information about the error message.

Navigation:

Click the Details button on the Freight Results page.

This example illustrates the fields and controls on the The Freight Results Detail page.

Freight Results Detail																																			
Business Unit		US010		Total Freight		4.550 USD																													
Delivery ID		1110000501		Shipping Weight		1.0000LBS																													
Frt Srvc Defn		TANDATA_USPS.USPS.PARCELPOST																																	
Service Descr		USPS PARCEL POST																																	
Freight Results Detail Personalize Find View All First 1 of 1 Last																																			
<table border="1"> <thead> <tr> <th>Package ID</th> <th>Ship Cntr ID</th> <th>Shipping Weight</th> <th>UOM</th> <th>Shipping Volume</th> <th>UOM</th> <th>Freight Amount</th> <th>Length</th> <th>Width</th> <th>Height</th> <th>Dim</th> <th>Freight Ref Num</th> </tr> </thead> <tbody> <tr> <td></td> <td></td> <td>1.0000</td> <td>LBS</td> <td></td> <td></td> <td>4.550</td> <td></td> <td></td> <td></td> <td></td> <td></td> </tr> </tbody> </table>												Package ID	Ship Cntr ID	Shipping Weight	UOM	Shipping Volume	UOM	Freight Amount	Length	Width	Height	Dim	Freight Ref Num			1.0000	LBS			4.550					
Package ID	Ship Cntr ID	Shipping Weight	UOM	Shipping Volume	UOM	Freight Amount	Length	Width	Height	Dim	Freight Ref Num																								
		1.0000	LBS			4.550																													
<div style="text-align: left;"> Return </div>																																			

Use the Freight Results Detail page to view the details of the freight results sent by the external third-party system including package level details. The details of each packages or shipping containers are

displayed including; freight amounts, shipping weights, shipping volume, dimensions, and freight reference numbers. If the integration fails, this page displays detailed information about the error message.

Running the Process Deliveries/Freight Process

The Process Deliveries/Freight process pages enables you to:

- Create deliveries.
- Change or maintain existing deliveries.
- Assign demand lines, shipping containers and packages to the deliveries.
- Calculate internal PeopleSoft freight charges.
- Request external carrier assignments, freight rating, and manifesting from external third-party freight systems. The Inventory Freight Request EIP and the Inventory Freight Response EIP are used.

You can use the Process Deliveries/Freight process with the third-party freight providers or the PeopleSoft internal freight calculation.

The PeopleSoft system contains two separate run control pages for the Process Deliveries/Freight process:

- The Process Deliveries/Freight process page in PeopleSoft Inventory is located in the following menu path: Inventory, Fulfill Stock Orders, Process Deliveries/Freight. This run control page enables you to request carrier assignments, freight rating, and manifesting from the external third-party freight provider. You can also complete post ship actions.
- The Process Deliveries/Freight process page in PeopleSoft Order Management is located in the following menu path: Order Management, Quotes and Orders, Process Orders, Process Deliveries/Freight. This run control page enables you to request freight amounts but not manifesting or post ship actions.

Page Used to Run the Process Deliveries/Freight Process

<i>Page Name</i>	<i>Definition Name</i>	<i>Usage</i>
<u>Process Deliveries/Freight Page</u>	RUN_IN_FULFILL_DEL	Enter search criteria and run the IN_FUL_DEL application engine process.
<u>Process Deliveries/Freight Process Page</u>	RUN_OM_DEL_FRT	Enter search criteria and run the OM_DEL_FRT application engine process.

Process Deliveries/Freight Page

Use the Process Deliveries/Freight page (RUN_IN_FULFILL_DEL) to enter search criteria and run the IN_FUL_DEL application engine process.

Navigation:

Inventory > Fulfill Stock Orders > Process Deliveries and Freight

This example illustrates the fields and controls on the The Process Deliveries/Freight process page in PeopleSoft Inventory (1 of 2).

This example illustrates the fields and controls on the The Process Deliveries/Freight process page in PeopleSoft Inventory (2 of 2). You can find definitions for the fields and controls later on this page.

Use the Process Deliveries/Freight process (IN_FUL_DEL) in PeopleSoft Inventory is used to:

- Create deliveries.
- Validate existing deliveries.

- Calculate freight using either the PeopleSoft internal calculator or the integration to an external third-party freight system. Freight can be calculated for the new deliveries or one or more existing delivery IDs.
- Direct the third-party freight system to manifest the deliveries.
- Complete post ship actions.
- Re-send a freight request to the external third-party freight system.

Field or Control	Description
Validate Delivery	<p>Select an option to validate the deliveries in this process run. The process confirms that the attributes of the delivery and the demand lines that are assigned to the delivery are still valid. The process looks for demand lines on the delivery that do not match the values in the delivery key fields defined on the Inventory Definition - Business Unit Options: Delivery Management page used to build a delivery. For example, if the carrier ID must be the same for all demand lines on the delivery but not all the demand lines have the same carrier ID, then the process produces an error. The process also recalculates the total weight and volume.</p> <p>The options are:</p> <ul style="list-style-type: none"> • <i>Do Not Validate</i>: Do not use this option. • <i>Reassign/Consolidate</i>: The process validates the deliveries and also removes invalid demand lines from a delivery and places them onto a new or existing delivery. Invalid demand lines are removed only from deliveries with an open status. The process creates new deliveries as needed. Before removing any demand lines from a delivery, the process first verifies that the action is allowed based on the processing rules. The processing rules prevent the removal and reassignment of a demand line to an existing delivery based on certain values in the IN_DELIVERY table. Processing rules prevent addition and removal when; the delivery status is closed or complete, the delivery is out for a freight request (Freight Status field is <i>Rate Requested</i>), a manifest has been created for this delivery (Manifest Status field is <i>Manifest Requested</i> or <i>Manifest Received</i>), or the Commit Freight for Billing field is <i>Y</i> (yes). • <i>Validate Only</i>: The process only validates the demand lines and deliveries. If demand lines are invalid for a delivery, then a message is written to the process log. It does not assign or remove any demand lines from deliveries. Use the Delivery Management Workbench to reassign any demand lines. • <i>Validate/Assign to New</i>: The process validates the deliveries and places any unassigned demand lines onto new deliveries. The process creates new deliveries as needed. Unassigned demand lines are not placed onto existing deliveries. If demand lines are invalid for an existing delivery, then a message is written to the process log. It does not remove any demand lines from deliveries. Use the Delivery Management Workbench to remove and reassign any demand lines. • <i>Validate/Auto Assign All</i>: This option is similar to the <i>Validate/Auto Assign Open</i> option except that invalid demand lines can be removed from deliveries in both the open and closed status. The process validates the deliveries, places any unassigned demand lines onto new or existing deliveries, and also removes invalid demand lines from a delivery and places them onto a new or existing delivery. Invalid demand lines are removed

Field or Control	Description
	<p>only from deliveries with an open or closed status. The processing rules prevent the addition or removal of a demand line to an existing delivery based on certain values in the IN_DELIVERY table. Processing rules prevent addition and removal when; the delivery status is complete, the delivery is out for a freight request (Freight Status field is <i>Rate Requested</i>), a manifest has been created for this delivery (Manifest Status field is <i>Manifest Requested</i> or <i>Manifest Received:</i>), or the Commit Freight for Billing field is <i>Y</i> (yes).</p> <ul style="list-style-type: none"> Validate/Auto Assign Open: The process validates the deliveries, places any unassigned demand lines onto new or existing deliveries, and also removes invalid demand lines from a delivery and places them onto a new or existing delivery. Invalid demand lines are removed only from deliveries with an open status. The process creates new deliveries as needed. Before adding or removing any demand lines from a delivery, the process first verifies that the action is allowed based on the processing rules. The processing rules prevent the addition or removal of a demand line to an existing delivery based on certain values in the IN_DELIVERY table. Processing rules prevent addition and removal when; the delivery status is closed or complete, the delivery is out for a freight request (Freight Status field is <i>Rate Requested</i>), a manifest has been created for this delivery (Manifest Status field is <i>Manifest Requested</i> or <i>Manifest Received:</i>), or the Commit Freight for Billing field is <i>Y</i> (yes).
Business Unit and To Business Unit	<p>If this run control should process one PeopleSoft Inventory business unit, enter the unit in the Business Unit field. If you want to process a range of business units, enter the starting unit in the Business Unit field and the ending business unit in the To Business Unit field. The system processes all PeopleSoft Inventory business units, sorted in alphanumerical order, that fall between the starting and ending unit.</p>
All Business Units	<p>Select this check box to process all PeopleSoft business units in this run control.</p>

Search Criteria

Use the following search criteria fields to identify the demand lines or deliveries to be picked up by this process.

Field or Control	Description
Fulfillment State	<p>Choose the demand fulfillment states of the demand lines to be selected.</p>

Field or Control	Description
Ship by Date	<p>Choose the date to select demand lines. Values are:</p> <ul style="list-style-type: none"> • <i>Order Date</i>: Select to process orders based on the order date. Enter a date range in the <i>Date From</i> and <i>To</i> fields. For just one specific date, use the <i>Date From</i> field only. • <i>Orders Placed Today</i>: Select to process orders entered in the system today. • <i>Schedule Date</i>: Select to process orders based on a the scheduled shipment date defined on the order demand line. Enter a date range in the <i>Date From</i> and <i>To</i> fields. For just one specific date, use the <i>Date From</i> field only. • <i>Ship Early Date</i>: Select to process orders based on the Earliest Ship Date field of the order demand line. Enter a date range in the Date From and To fields. For just one specific date, use the Date From field only.
Date From and To	Enter the dates to retrieve orders or demand lines. This is based on the entry in the Ship by Date field.
Demand Source	Enter the PeopleSoft application where the demand lines originated.
Source Unit	Enter the business unit where the demand lines originated. For sales orders, this is the PeopleSoft Order Management business unit. For material stock requests, this is the PeopleSoft Inventory business unit.
Order Number and To	Enter the order number or range of order numbers to be processed. The order can be a sales order from PeopleSoft Order Management or a material stock request from PeopleSoft Inventory. If you enter a range of orders using the Order Number and To fields, then the system processes all orders, sorted in alphanumerical order, that fall between the starting and ending order numbers.
Order Line and Schedule Line	Enter the line number and schedule line number of the order number specified above.

Field or Control	Description
Ship ID	Enter the shipping ID to select orders using a previously assigned shipping ID.
Delivery ID and To Delivery ID	Leave this field blank if you are creating a new delivery with this process. If this run control should process one existing delivery, enter the delivery ID in the Delivery ID field. If you want to process a range of deliveries, enter the starting delivery ID in the Delivery ID field and the ending delivery ID in the To Delivery ID field. The system processes all deliveries, sorted in alphanumerical order, that fall between the starting and ending IDs.
Carrier ID	Select one carrier.
Ship Via	Select one shipping method.
Route Group and Route Code	Select a particular transportation grouping and transportation route.
Customer ID	Select a particular customer.
Location	Enter to select orders that were entered for a particular location code. Location codes represent the business unit's address, a branch office, or shipping office. Location codes are defined on the Location Definition page (Set Up Financials/Supply Chain, Common Definitions, Location, Location). Search results include the demand lines or deliveries containing the demand lines that meet this search criteria.
Ship To Customer and Address Number	Select a Ship To Customer ID and address.
Pick Batch ID and To	Select a pick batch ID or a range of pick batch IDs assigned by the Order Release process.
Pick Line and To	Select a pick line number within a pick batch ID or a range of line numbers.
TMS Reference ID and TMS Reference Line	Select a TMS reference ID or line number assigned during the interface to the transportation management system (TMS).

Field or Control	Description
External Reference ID and External Reference Line	Select an external reference number and line. The external reference information is assigned when warehouse management system (WMS) orders are downloaded using the Shipping Order Release EIP.
Load ID	Select a single load ID.
Ship Container ID	Select a single shipping container.
Priority and To	<p>Enter a shipping priority code or range of codes that are assigned to sales orders in PeopleSoft Order Management.</p> <hr/> <p>Note: Within PeopleSoft, this field is only relevant for sales orders or interunit transfers created from PeopleSoft Supply Planning. However, the field is always available for entry to support modifications and third-party integration.</p> <hr/>
Item ID	Select an item ID.
Product ID	Select a product ID from PeopleSoft Order Management.
Parent Product ID	Select a parent ID of a product kit from PeopleSoft Order Management.

Freight Controls group box

Use the Freight Controls group box to determine your freight settings for the process.

Field or Control	Description
Calculate Freight	Select this check box to have this process calculate freight for the selected deliveries. Depending on the delivery parameters, this process can calculate freight using either the PeopleSoft internal calculator or the integration to an external third-party freight system. For a delivery using third-party freight, selecting this check box directs the process to launch the Inventory Freight Request EIP. Freight can be calculated for the new deliveries or one or more existing delivery IDs.

Field or Control	Description
Freight Type	Enter the freight type code to be used by the external third-party freight system. Freight types are defined at the SetID level and used to derive the correct service definition to send with the outbound message to the third-party provider.
Freight Options	<p>Select one of the following freight options to request freight from an external third-party freight system:</p> <ul style="list-style-type: none"> • <i>Best Way</i>: The PeopleSoft system sends a best way request to the third-party provider system and the third-party provider returns only one freight choice per delivery ID. Use the Best Way group box to choose the best way option. The best way options are least cost or by commit date. • <i>Use Specified Carrier</i>: The PeopleSoft system sends a request with a specific carrier ID to the third-party provider system and the third-party provider returns only freight choices from the specified carrier. • <i>Carrier with Best Way</i>: Select this option to enable the third-party freight system to return freight results when the carrier ID field is blank on a delivery that uses the <i>Use Specified Carrier</i> freight option. If the PeopleSoft system sends a delivery using the <i>Use Specified Carrier</i> freight option and the delivery does not have a carrier ID assigned to it, then the <i>Best Way</i> freight option is used.
Best Way	<p>If you have selected <i>Best Way</i> or <i>Carrier with Best Way</i> in the Freight Options group box, then use this group box to choose your best way option:</p> <ul style="list-style-type: none"> • <i>Least Cost</i>: The third-party freight system selects and returns the freight service with the least cost. • <i>By Commit Date</i>: The third-party freight system selects and returns the freight service that best matches the scheduled ship date.
Complete Delivery	Select this check box to set the status of the delivery to <i>Complete Delivery</i> which indicates that all fulfillment steps for the delivery are completed and all demand lines in the delivery are ready to be depleted using the Deplete On Hand Qtys process. If the PeopleSoft Inventory business unit is using deliveries, the Deplete On Hand Qtys process only pick ups demand lines that are on a delivery with the Complete Delivery status.

Field or Control	Description
Commit Freight for Billing	Select this check box to indicate that the freight on this delivery is ready to be processed by PeopleSoft Billing and by PeopleSoft Cost Management.
External Manifest	Select this check box to instruct the external third-party freight system to create or update shipping manifests for the individual carriers. Label URL references and tracking numbers for the selected deliveries, containers, and packages, are sent to the PeopleSoft system and maintained with the shipping history information. In order to use external manifest all of the demand lines in the delivery must be in the fulfillment state of Shipped. A freight option of Best Way or Use Specified Carrier must be selected to perform external manifesting.
Resend Requested Freight	Select this check box to re-send deliveries that are in a <i>Requested</i> status. Use this option if you had a problem with the original EIP transaction and you want to send the transaction again.
Resend Received Freight	Select this check box to re-freight a delivery that has already been freighted. Normally, this process selects deliveries that have not yet been sent for freighting.

Process Deliveries/Freight Process Page

Use the Process Deliveries/Freight page (RUN_OM_DEL_FRT) to enter search criteria and run the OM_DEL_FRT application engine process.

Navigation:

Order Management > Quotes and Orders > Process Orders > Process Deliveries and Freight

This example illustrates the fields and controls on the The Process Deliveries/Freight page in PeopleSoft Order Management. You can find definitions for the fields and controls later on this page.

Process Deliveries/Freight

Run Control ID Deliveries Report Manager Process Monitor **Run**

Validate Delivery ▾

Perform Freight

Resend Requested Freight

Resend Received Freight

Process Request Parameters Personalize | Find | View All | First 1 of 1 Last

Order Selection	Date Selection								
*Order Management Unit	Ship From Unit	From Order	To Order	Source Code	Ship To Customer	Carrier ID	Ship Via		
1 US001		C-Q0501	C-Q0501						

Use the Process Deliveries/Freight process (OM_DEL_FRT) in PeopleSoft Order Management is used to:

- Create deliveries.
- Validate existing deliveries.
- Calculate freight using either the PeopleSoft internal calculator or the integration to an external third-party freight system. Freight can be calculated for the new deliveries or one or more existing delivery IDs.
- Re-send a freight request to the external third-party freight system.

Field or Control	Description
Validate Delivery	<p>Select an option to validate the deliveries in this process run. The process confirms that the attributes of the delivery and the demand lines that are assigned to the delivery are still valid. The process looks for demand lines on the delivery that do not match the values in the delivery key fields defined on the Inventory Definition - Business Unit Options: Delivery Management page used to build a delivery. For example, if the carrier ID must be the same for all demand lines on the delivery but not all the demand lines have the same carrier ID, then the process produces an error. The process also recalculates the total weight and volume.</p> <p>The options are:</p> <ul style="list-style-type: none"> • <i>Do Not Validate</i>: Do not use this option. • <i>Reassign/Consolidate</i>: The process validates the deliveries and also removes invalid demand lines from a delivery and places them onto a new or existing delivery. Invalid demand lines are removed only from deliveries with an open status. The process creates new deliveries as needed. Before removing any demand lines from a delivery, the process first verifies that the action is allowed based on the processing rules. The processing rules prevent the removal and reassignment of a demand line to an existing delivery based on certain values in the IN_DELIVERY table. Processing rules prevent addition and removal when; the delivery status is closed or complete, the delivery is out for a freight request (Freight Status field is <i>Rate Requested</i>), a manifest has been created for this delivery (Manifest Status field is <i>Manifest Requested</i> or <i>Manifest Received</i>), or the Commit Freight for Billing field is <i>Y</i> (yes). • <i>Validate Only</i>: The process only validates the demand lines and deliveries. If demand lines are invalid for a delivery, then a message is written to the process log. It does not assign or remove any demand lines from deliveries. Use the Delivery Management Workbench to reassign any demand lines. • <i>Validate/Assign to New</i>: The process validates the deliveries and places any unassigned demand lines onto new deliveries. The process creates new deliveries as needed. Unassigned demand lines are not placed onto existing deliveries. If demand lines are invalid for an existing delivery, then a message is written to the process log. It does not remove any demand lines from deliveries. Use the Delivery Management Workbench to remove and reassign any demand lines. • <i>Validate/Auto Assign All</i>: This option is similar to the <i>Validate/Auto Assign Open</i> option except that invalid demand lines can be removed from deliveries in both the open and closed status. The process validates the deliveries, places any unassigned demand lines onto new or existing deliveries, and also removes invalid demand lines from a delivery and places them onto a new or existing delivery. Invalid demand lines are removed

Field or Control	Description
	<p>only from deliveries with an open or closed status. The processing rules prevent the addition or removal of a demand line to an existing delivery based on certain values in the IN_DELIVERY table. Processing rules prevent addition and removal when; the delivery status is complete, the delivery is out for a freight request (Freight Status field is <i>Rate Requested</i>), a manifest has been created for this delivery (Manifest Status field is <i>Manifest Requested</i> or <i>Manifest Received</i>), or the Commit Freight for Billing field is <i>Y</i> (yes).</p> <ul style="list-style-type: none"> Validate/Auto Assign Open: The process validates the deliveries, places any unassigned demand lines onto new or existing deliveries, and also removes invalid demand lines from a delivery and places them onto a new or existing delivery. Invalid demand lines are removed only from deliveries with an open status. The process creates new deliveries as needed. Before adding or removing any demand lines from a delivery, the process first verifies that the action is allowed based on the processing rules. The processing rules prevent the addition or removal of a demand line to an existing delivery based on certain values in the IN_DELIVERY table. Processing rules prevent addition and removal when; the delivery status is closed or complete, the delivery is out for a freight request (Freight Status field is <i>Rate Requested</i>), a manifest has been created for this delivery (Manifest Status field is <i>Manifest Requested</i> or <i>Manifest Received</i>), or the Commit Freight for Billing field is <i>Y</i> (yes).
Perform Freight	<p>Select this check box to have this process calculate freight for the selected deliveries. Depending on the delivery parameters, this process can calculate freight using either the PeopleSoft internal calculator or the integration to an external third-party freight system. For a delivery using third-party freight, selecting this check box directs the process to launch the Inventory Freight Request EIP. Freight can be calculated for the new deliveries or one or more existing delivery IDs.</p>
Resend Requested Freight	<p>Select this check box to re-send deliveries that are in a <i>Requested</i> status. Use this option if you had a problem with the original EIP transaction and you want to send the transaction again.</p>
Resend Received Freight	<p>Select this check box to re-freight a delivery that has already been freighted. Normally, this process selects deliveries that have not yet been sent for freighting.</p>
Process Request Parameters	<p>Use the search criteria fields in this group box to identify the demand lines or deliveries to be picked up by this process.</p>

Sending Freight Requests to the Third-Party Freight System

PeopleSoft sends messages (transaction requests) with sales order and delivery data to the external third-party freight system using the third-party freight EIPs (service operations) in the PeopleSoft Integration Broker. The following service operations are used to send data:

- *Inventory Freight Rate Request*: This synchronous (two-way) service operation is used from the Order Entry Form and the Delivery Management Workbench to send a freight request transaction request and receive an immediate response from the third-party freight system.
- *Inventory Freight Request*: This asynchronous (one-way) service operation is used by the Order Completion process, the Process Deliveries/Freight process, and the fulfillment engine shipping processes to send a freight request transaction request to the third-party system.
- *Inventory Freight Ship Request*: This synchronous (two-way) service operation is used from the Delivery Management Workbench or the Shipping/Issue component to send a freight request message and receive an immediate response from the third-party freight system. In addition, this service operation enables you to request that the third-party freight system generate the manifest. The third-party freight system can be used to create, maintain, and print the shipping manifests. The response coming from the third-party system can send tracking numbers and label URL references to be stored in the PeopleSoft shipping history tables. This service operation can only be initiated for shipped deliveries.

See [Enabling the PeopleSoft EIPs for Third-Party Freight](#).

Transaction requests can be sent to an external third-party freight system using the following PeopleSoft page and processes:

- The Order Entry Form in PeopleSoft Order Management can launch the Inventory Freight Rate Request service operation. Using this online component, a user can request rate shopping, best way, or a specified carrier and receive an immediate response from the third-party freight system.

See "Understanding the Sales Order Entry Form" (PeopleSoft Order Management).

- The Delivery Management Workbench in PeopleSoft Inventory can launch the Inventory Freight Rate Request service operation (for freighting only) or launch the Inventory Freight Ship Request service operation (for freighting and manifesting). Using this online component, a user can request rate shopping, best way, or a specified carrier and receive an immediate response from the third-party freight system.

See [Using the Delivery Management Workbench](#).

- The Order Completion process in PeopleSoft Order Management can launch the Inventory Freight Request service operation. This process can create deliveries by grouping sales order demand lines and then send the batch of deliveries to the third-party freight system. This process provides an efficient way to request freight for a large number of sales orders. You always generate a non-manifesting freight request when making this request from the Order Completion process.

See "Running Order Completion/Repricing" (PeopleSoft Order Management).

- The Process Deliveries/Freight process in the PeopleSoft Order Management menu can launch the Inventory Freight Request service operation. This process page enables you to create deliveries and then send the deliveries to the third-party freight system. You always generate a non-manifesting

freight request when making this request from the Process Deliveries/Freight process within the Order Management menu.

See [Running the Process Deliveries/Freight Process](#).

- The Process Deliveries/Freight process in the PeopleSoft Inventory menu can launch the Inventory Freight Request service operation. This process page enables you to create deliveries and then send the deliveries to the third-party freight system. When making a freight request from the Process Deliveries/Freight process within the Inventory menu, you can generate a manifesting or non-manifesting freight request based on the External Manifest check box on the process page.

See [Running the Process Deliveries/Freight Process](#).

- The fulfillment engine shipping processes can launch the Inventory Freight Request service operation. These processes enable you to create deliveries and then send the deliveries to the third-party freight system. When making this request from the fulfillment engine shipping processes, you always generate a manifesting freight request.

See "Understanding the Fulfillment Engine" (PeopleSoft Inventory).

- The Shipping / Issues component in PeopleSoft Inventory can launch the Inventory Freight Ship Request service operation for freighting and manifesting. The Shipping / Issues component also provides a link to the Delivery Management Workbench.

See "Using the Shipping/Issues Component" (PeopleSoft Inventory).

Receiving Freight Data from the Third-Party Freight System

The external third-party freight system sends messages (transaction requests) with freight rates, carrier assignments, tracking numbers, and label URL references to the PeopleSoft system using the third-party freight EIPs (service operations) in the PeopleSoft Integration Broker. The following service operations are used to receive data:

- *Inventory Freight Rate Request:* This synchronous (two-way) service operation is used from the Order Entry Form and the Delivery Management Workbench to send a freight request transaction request and receive an immediate response from the third-party freight system.
- *Inventory Freight Response:* This asynchronous (one-way) service operation is used by the external third-party system to respond to the Inventory Freight Request service operation transaction request. In addition, the third-party freight system can use the Inventory Freight Response service operation by itself to initiate the data transfer (push) by passing freight amounts to PeopleSoft without first receiving an Inventory Freight Request transaction request. This data from an Inventory Freight Response transaction request is received into PeopleSoft using the Inbound Freight process (located within the Fulfillment Requests process page) which updates the delivery and demand tables (IN_DEMAND) in PeopleSoft Inventory.
- *Inventory Freight Ship Request:* This synchronous (two-way) service operation is used from the Delivery Management Workbench or the Shipping/Issues component to send a freight request message and receive an immediate response from the third-party freight system. In addition, this service operation enables you to request that the third-party freight system generate the manifest. The third-party freight system can be used to create, maintain, and print the shipping manifests. The response coming from the third-party system can send tracking numbers and label URL references

to be stored in the PeopleSoft shipping history tables. This service operation can only be initiated for shipped deliveries.

For more information on the setup of the third-party freight EIPs, see [Enabling the PeopleSoft EIPs for Third-Party Freight](#).

Inventory Freight Response transactions sent by an external third-party freight system are received into PeopleSoft using the following steps:

1. The PeopleSoft Integration Broker receives an inbound XML message into the INVENTORY_FREIGHT_RESPONSE queue. The InventoryFreightResponse handler, a PeopleTools application class, formats the incoming data and populates the staging tables. For each transaction request, the InventoryFreightResponse handler assigns a unique ID called the EIP_CTL_ID. Some validations are performed by the InventoryFreightResponse handler, if the inbound message fails these validations then an error is generated and the message is not inserted into the staging tables. For example, if the business unit is invalid then the transaction is not written to the staging tables.
2. Run the Fulfillment Requests process (IN_FUL_BCT) using the 0380 transaction code (Freight). The Fulfillment Requests process retrieves the transaction requests from the staging tables, processes them, and applies them to the PeopleSoft Inventory delivery and demand tables. You can run this process manually or schedule this process to run in the background on a regular basis. Keep in mind the following points about the incoming data:
 - If a response code other than zero (success) is returned from the freight system, then the transaction is written to the staging tables in an error status. The Fulfillment Request process does not process transactions in an error status. Use the Transaction Maintenance page to review the error.
 - If multiple shipment segments (or estimates for shipping services) are returned on a single Inventory Freight Response transaction, then the InventoryFreightResponse handler inserts all of these segments into the staging tables. It is important to note that only the first shipment segment is processed by the Fulfillment Request process. All other shipment segments for a single delivery are maintained strictly for viewing purposes.
3. If the transaction requests are successfully processed, then they are set to a status of complete. If the transaction requests are not processed successfully, they are given an error status, and the appropriate error message is provided. The Maintain Transactions component enables you to view and correct requests that contain errors. Once corrected, you can relaunch the Fulfillment Requests process. This is an optional step, you can choose to have the request errors canceled automatically, and then you could create another request.

Pages Used to Receive Freight Data from the Third-Party Freight System

<i>Page Name</i>	<i>Definition Name</i>	<i>Usage</i>
Asynchronous Services Page	IB_MONITOR_OVRVIEW	System administrators use the Service Operations Monitor to monitor asynchronous service operations information, node status, queue status, manage domains and more.

Page Name	Definition Name	Usage
<u>Synchronous Services Page</u>	AMM_SYNCMSGLIST	System administrators use the Service Operations Monitor to monitor synchronous service operations information, node status, queue status, manage domains and more.
<u>Fulfillment Requests Page</u>	BCT_INV_REQFUL	Establish run control parameters for the Fulfillment Requests process to retrieve the transaction requests from the staging tables, process them, and apply them to the PeopleSoft tables. The transaction code 0380 (Freight) processes freight rates, carrier assignments, tracking numbers, and label URL references received from the third-party freight system. One message can have multiple transactions. Each transaction is one delivery and is assigned a separate BCT CTL ID (batch control ID).
<u>Transaction Maintenance Page</u>	BCT_CTL_UPD	View all transaction requests in the transaction log (inbound staging tables) and access the detail pages that enable you to correct transaction errors. For data received from third-party freight systems, select Freight Request in the Transaction field and click the Search button.
<u>Transaction Maintenance- Freight Page</u>	BCT_INV_UPD_FRT	View data received from a third-party system for one delivery ID. Each EIP Control ID (BCT CTL ID) is a separate delivery. Using this page, you can view the status of an individual delivery and view any error messages found during the Fulfillment Requests process.
Transaction Maintenance- Freight: Shipments Page	BCT_FRT_SHP_SP	Displays the individual shipments within this transaction request. You can view or edit fields related to this shipment; such as, freight amount and scheduled arrival date.
Transaction Maintenance- Freight: Packages Page	BCT_FRT_PKG_SP	Displays the packages within the delivery. You can view or edit information about each package including freight amount, tracking number, shipping weight, and shipping volume.

Synchronous Services Page

Use the Synchronous Services page (AMM_SYNCMSGLIST) to system administrators use the Service Operations Monitor to monitor synchronous service operations information, node status, queue status, manage domains and more.

Navigation:

PeopleTools > Integration Broker > Service Operations Monitor > Monitoring > Synchronous Services.

This example illustrates the fields and controls on the The Service Operations Monitor page for synchronous services.

Use the Asynchronous Services page (IB_MONITOR_OVRVIEW) to system administrators use the Service Operations Monitor to monitor asynchronous service operations information, node status, queue status, manage domains and more.

Navigation:

PeopleTools > Integration Broker > Service Operations Monitor > Monitoring > Asynchronous Services.

This example illustrates the fields and controls on the The Service Operations Monitor page for Asynchronous services.

The screenshot shows the 'Monitor Overview' tab selected. It includes a search bar for 'Publish', a 'Time Period' section with 'From Date', 'To Date', 'From Time', and 'To Time' fields, and a 'Refresh' button. Below these are filter options for '*Queue Level' (set to 'Oper Instance') and '*Group By' (set to 'Queue'). There are also checkboxes for 'Archived' and 'User Level View'. The main area displays a table of queue statuses with columns for Queue Name, Queue Status, and various operational metrics.

Queue Name	Queue Status	Error	New	Started	Working	Done	Retry	Timeout	Edited	Canceled	Hold	Submit	Done/NoAck
EOEN_MSG_CHNL	Running	0	1	0	0	0	0	0	0	0	0	0	0
PSRF_REPORTING_FOLDERS	Running	0	101	0	0	0	0	0	0	0	0	0	0
PTSF_SES_FEEDS	Running	0	2	0	0	0	0	0	0	0	0	0	0
TREE_MAINT	Running	0	7	0	0	0	0	0	0	0	0	0	0
USER_PROFILE	Running	0	25	0	0	0	0	0	0	0	0	0	0

System administrators monitor asynchronous and synchronous service operations information, node status, queue status, manage domains and more.

For more information on the Service Operations Monitor, see the Using the Service Operations Monitor topic in *PeopleTools: Integration Broker*

Fulfillment Requests Page

Use the Fulfillment Requests page (BCT_INV_REQFUL) to establish run control parameters for the Fulfillment Requests process to retrieve the transaction requests from the staging tables, process them, and apply them to the PeopleSoft tables.

The transaction code 0380 (Freight) processes freight rates, carrier assignments, tracking numbers, and label URL references received from the third-party freight system. One message can have multiple transactions. Each transaction is one delivery and is assigned a separate BCT CTL ID (batch control ID).

Navigation:

SCM Integrations > Process Transactions > Inventory > Fulfillment Requests

This example illustrates the fields and controls on the Fulfillment Requests process page using the 0380 transaction code. You can find definitions for the fields and controls later on this page.

The Fulfillment Requests process retrieves the transaction requests from the staging tables, processes them, and applies them to the PeopleSoft Inventory delivery and demand tables.

Field or Control	Description
Transaction Code	Enter the transaction code 0380 (Freight) to launch the Inbound Freight application engine and retrieve freight information from the staging tables.
Freight Rollup Flag	<p>Determines which freight charges are picked up and applied to the delivery in the Freight Amount field of the IN_DELIVERY_FRT table. The options are:</p> <ul style="list-style-type: none"> <i>Delivery Freight:</i> The freight amount calculated at the delivery level by the external system should be stored at the delivery-level in PeopleSoft. This amount is used for billing and costing. <i>Rollup Packages/Containers:</i> (external system only) The freight amounts calculated by the external system at the shipping container and package levels should be summed and stored at the delivery-level in PeopleSoft. This total is used for billing and costing. <i>Default from Delivery:</i> or blank field: The system uses the Freight Rollup value already defined on the delivery. <p>See Receiving Freight Charges.</p>

Field or Control	Description
Maximum Retries	Enter the number of times to attempt the freight transaction before setting it to an error status. This option is used in environments that are posting both shipping and freight transactions for the same delivery. For a specific delivery, if the freight manifest transaction processes before the shipment transaction then the freight transaction will error. This option is used to prevent the freight transaction from going to an error status until the maximum number of retries.
Complete Delivery	Select this check box to set the status of the delivery to <i>Complete Delivery</i> which indicates that all fulfillment steps for the delivery are complete and all demand lines in the delivery are ready to be depleted using the Deplete On Hand Qtys process. If the PeopleSoft Inventory business unit is using deliveries, the Deplete On Hand Qtys process only pick ups demand lines that are on a delivery with the Complete Delivery status.
Commit Freight for Billing	Select this check box to indicate that the freight on this delivery is ready to be processed by PeopleSoft Billing and by PeopleSoft Cost Management.

Note: Post ship actions within the Post Ship Actions group box cannot be performed until all demand lines associated with a delivery have been shipped.

Transaction Maintenance Page

Use the Transaction Maintenance page (BCT_CTL_UPD) to view all transaction requests in the transaction log (inbound staging tables) and access the detail pages that enable you to correct transaction errors.

For data received from third-party freight systems, select Freight Request in the Transaction field and click the Search button.

Navigation:

SCM Integrations > Transaction Error Handling > Maintain Transactions

This example illustrates the fields and controls on the Transaction Maintenance page. You can find definitions for the fields and controls later on this page.

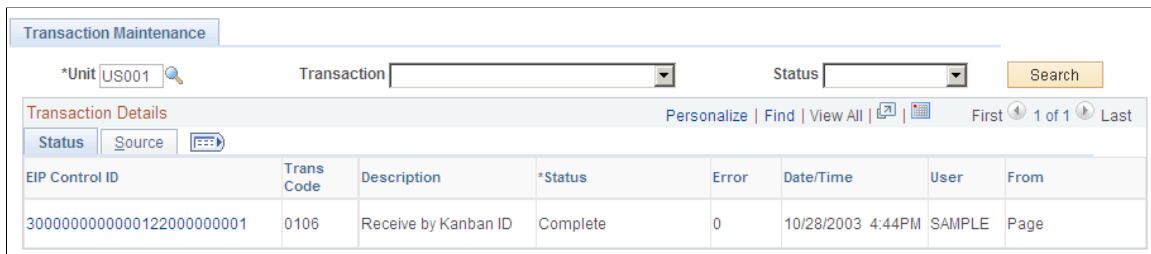

The Transaction Maintenance page displays transactions from the inbound staging tables and is used to view the status of the incoming transactions. If errors are found during the Fulfillment Request process, the transaction status in the transaction log is changed to *Error*, and rows are inserted into error tables for each error message.

Field or Control	Description
Unit	Select the Inventory business unit for your search.
Transaction	Select the type of transaction to be viewed in your search results. Leave the field blank to view all transaction types within an Inventory business unit. Use the value <i>Freight</i> to view transaction requests bringing freight data from a third-party freight system.
Status	Select the status of the transaction requests to be viewed in your search results. Leave the field blank to select all statuses. Your options are: <ul style="list-style-type: none"> • <i>New</i> • <i>In Process</i> • <i>Complete</i> • <i>Error</i> • <i>Reprocess</i>
Search	Click the search button to display results in the Transaction Details group box.
EIP Control ID	When displaying a Freight Request transaction, click this link to access the Transaction Maintenance- Freight page.
Trans Code and Description	Displays the transaction code and description for the transaction request.
Status	Displays the current status of the transaction request. You can edit this field and change the status. <p>The rules for changing a transaction status are:</p> <ul style="list-style-type: none"> • The statuses of <i>New</i>, <i>Error</i>, or <i>Reprocess</i> can be changed to the status of <i>Complete</i>. This cancels all lines in the transaction. • The <i>Complete</i>, <i>In Process</i>, and <i>Incomplete</i> statuses cannot be changed.
Error	Displays the number of errors within the transaction request.

See "Transaction Maintenance Page" (PeopleSoft Supply Chain Management Integration).

Transaction Maintenance- Freight Page

Use the Transaction Maintenance- Freight component to view and correct any errors. Once you have corrected the information and saved the component, the transaction request is ready to be reprocessed using the Fulfillment Requests process.

Top Level

Use the Transaction Maintenance- Freight page (BCT_INV_UPD_FRT) to view data received from a third-party system for one delivery ID.

Each EIP Control ID (BCT CTL ID) is a separate delivery. Using this page, you can view the status of an individual delivery and view any error messages found during the Fulfillment Requests process.

Navigation:

Click the EIP Control ID link on the Transaction Maintenance page.

This example illustrates the fields and controls on the Transaction Maintenance-Freight Request page. You can find definitions for the fields and controls later on this page.

The screenshot displays the Transaction Maintenance-Freight Request page. At the top, there is a 'Freight' tab. Below the tab, the following information is shown:

- Unit: US010
- EIP ID: 1013356570626309000000001
- Source
- Transaction: Freight
- Status: New
- Src Ref

The 'Transaction Details' section includes the following fields and controls:

- Sequence Number: 1
- Trans Code: 0380 Freight
- *Status: Open (dropdown menu)
- Business Unit: US010
- Delivery ID: 1110000087 (with search icon)
- Shipment Errors: 0
- All Records (dropdown menu)
- Freight Rollup Flag: Default from Delivery (dropdown menu)
- Manifest: Manifest
- Shipments: [Shipments](#)
- Response Code:
- Error Code: 0
- Transaction Source
- Source Reference
- Source Sequence

The 'Edit Details' section shows a table with the following columns: Field Name, Date/Time, and Message. A 'Message Detail' entry is visible in the table. A 'Return' button is located at the bottom left of the page.

Transaction Maintenance-Freight Request page displays top-level information of a freight request transaction. You can view the status of the entire transaction request and view any error messages found during the Fulfillment Requests process.

The Transaction Details group box displays the deliveries within this transaction request. There could be one or more deliveries within a transaction request.

Field or Control	Description
Status	<p>For the transaction request, this field displays the current status. The statuses are:</p> <ul style="list-style-type: none"> • Open • Error • Complete • Cancel
Freight Rollup Flag	<p>Determines which freight charges are picked up and applied to the delivery in the Freight Amount field of the IN_DELIVERY_FRT table. The options are:</p> <ul style="list-style-type: none"> • <i>Delivery</i>: The freight amount calculated at the delivery level by the internal or external system should be stored at the delivery-level in PeopleSoft. This amount is used for billing and costing. This option must be used for the internal PeopleSoft freight calculator. • <i>Rollup</i>: (external system only) The freight amounts calculated by the external system at the shipping container and package levels should be summed and stored at the delivery-level in PeopleSoft. This total is used for billing and costing. • <i>Default</i>: or blank field: The system uses the Freight Rollup value already defined on the delivery. <p>See Receiving Freight Charges.</p>
Manifest	<p>This check box is selected when a manifest action was received from the third-party freight provider system.</p>

Shipment Level

Use the Transaction Maintenance- Freight: Shipments page (BCT_FRT_SHP_SP) to displays the individual shipments within this transaction request.

You can view or edit fields related to this shipment; such as, freight amount and scheduled arrival date.

Navigation:

Click the Shipments link on the Transaction Maintenance- Freight page.

This example illustrates the fields and controls on the Transaction Maintenance- Freight: Shipments page.

The screenshot shows a web application window titled "Shipments". At the top, it displays summary information: Unit US010, EIP ID 1947625906182278835200001, Source Transaction Freight, Status New, and Src Ref. Below this is a "Transaction Details" section with a search bar and navigation controls (Find | View All, First, 1 of 1, Last). The details include: Sequence Number 2, Trans Code 0381 Freight Shipment Services, *Status Open, Business Unit US010, Delivery ID 1110000501, Package Errors 0, All, Carrier ID (input field), Ship Via (input field), Packages (link), Freight Service (input field), Service Descr (input field), Freight Amount (input field), Total Pieces (input field), Shipping Weight (input field), Pro Number (input field), Shipping Volume (input field), External Shipment (input field), Scheduled Date/Time (input field), and Scheduled Arrival (input field). Below the details is an "Error Code" section with an "Edit Errors" sub-section containing a table with columns "Field Name" and "Message". A "Message Detail" link is visible below the table. At the bottom of the window are "OK" and "Cancel" buttons.

Displays the individual shipments within a delivery. Using the shipment-level, you can view fields related to a shipment; such as, scheduled arrival date. You can edit fields related to the first shipment only.

Package Level

Use the Transaction Maintenance- Freight: Packages page (BCT_FRT_PKG_SP) to displays the packages within the delivery.

You can view or edit information about each package including freight amount, tracking number, shipping weight, and shipping volume.

Navigation:

Click the Packages link on the Transaction Maintenance- Freight: Shipments page.

This example illustrates the fields and controls on the Transaction Maintenance- Freight: Packages page.

Packages

Unit US010	EIP ID 10133565706263090000000001	Source
Transaction Freight	Status New	Src Ref

Transaction Details
Find | View All
First 1 of 1 Last

Sequence Number 3	Trans Code 0383 Freight Package	*Status Open
Business Unit US010	Delivery ID 1110000087	
Package ID <input type="text"/>	Ship Container Inquiry <input type="text"/>	
Freight Amount <input type="text"/>	Container Type <input type="text"/>	
Shipping Weight <input type="text"/>	External Packaging ID <input type="text"/>	
Shipping Volume <input type="text"/>	Reference Number <input type="text"/>	
Ship Length <input type="text"/>	Tracking Number <input type="text"/>	
Ship Height <input type="text"/>		
Ship Width <input type="text"/>		
Error Code		

Edit Errors
Find | View All
First 1 of 1 Last

Field Name	Message
Date/Time	

▶ Message Detail

The Transaction Details group box displays one or more packages within a shipment. Use the Transaction Details scroll bar to additional packages within the same shipment. Using this page, you can view or edit information about each package including freight amount, tracking number, package label URL references, shipping weight, and shipping volume.

Chapter 6

Pegging Supply and Demand

Understanding Pegging

Pegging links demand to incoming supply. You can create a peg chain between a supply transaction and a demand transaction from either side. Demand transactions can peg to supply transactions and, conversely, supply transactions can peg to demand transactions. A peg prevents the incoming supply from being reserved, or allocated to another demand transaction.

Sources of supply include:

- Requisitions and purchase orders from PeopleSoft Purchasing
- Incoming interunit transfers into the inventory business unit from another inventory business unit
- The primary outputs of Production IDs from PeopleSoft Manufacturing

Sources of demand include:

- Materials stock requests in PeopleSoft Inventory
- Outgoing interunit transfers from the inventory business unit to another inventory business unit
- Sales orders from PeopleSoft Order Management
- Work orders from PeopleSoft Maintenance Management

Note: You cannot create a peg to stock that has been received and putaway in the inventory business unit.

There are two types of pegs:

- A *soft peg* links an outgoing order to the quantity included in an incoming supply. A soft pegged supply can be pegged to one or many demands. A soft pegged demand can be pegged to one or many supply orders. When a soft peg is changed or canceled, the peg is changed but the other side of the peg (that is, the incoming supply or outgoing demand) is not changed. A notification is sent using the Message Dashboard. For example, a sales order for 10 units is soft pegged to an incoming purchase order with 2,000 units. Later, the customer service representative changes the sales order quantity from 10 units to 2 units. When the sales order is altered, the system changes the peg but the incoming supply (in this case the purchase order) is not changed. A notification is sent to the buyer (on the PO) informing them that a change in the demand pegged to the PO has taken place. Soft pegs are useful when items are in short supply and you want to peg higher priority customer orders to specific supply.
- A *hard peg* is created when a sales order (demand) creates a new purchase order, requisition, or interunit transfer to fulfill it. A hard pegged supply/demand can only be pegged to a single demand/supply. All other orders would be considered soft pegs and result in notifications only upon changes. When a hard peg is changed or canceled, not only is the peg changed, but also the incoming supply is changed. For example, a sales order for 10 units is hard pegged to an incoming purchase order with 10

units. If the sales order is changed to 4 units, then the purchase order is changed to 4 units. Hard pegs are useful for make-to-order items or special products.

Note: A change to a hard-pegged supply transaction does not update the demand transaction.

To create, change, or cancel a peg chain, you can:

- Access the Pegging Workbench where you can link demand to supply or supply to demand. The Pegging Workbench can be accessed directly through the menu or by a link located on other components in **PeopleSoft Inventory > Order Management > Manufacturing > Purchasing > and Maintenance Management**.
- Create pegs from the Alternate Sources of Supply page in PeopleSoft Order Management.
- Create pegs from the Maintain Requisitions or Maintain Purchase Orders components in PeopleSoft Purchasing for work orders with non-inventory items and description-only items.

Information about peg chains can be viewed and monitored using the:

- Pegging Inquiry page where you can view the pegging information without changing it.
- Pegging Exception report to review problems in pegging due to changes in dates, quantities, or canceled orders; for example, the supply date is later than the demand ship date.

Rules for Items

For *inventory items*, the following rules apply:

- Product kits cannot be pegged; however the kit components on a demand line can be pegged.
- Configured product kits cannot be pegged.
- VMI (vendor-managed inventory) items cannot be pegged.
- ATP (available to promise) items can be pegged from a work order from PeopleSoft Maintenance Management. ATP items cannot be pegged from material stock requests or sales orders; however, ATP items can be pegged to an transfer supply (interunit transfer).
- Only soft-reserve items can be pegged when working with material stock requests and sales orders. Work orders can use items that are not defined as soft-reserved.
- Return to vendor stock requests cannot be pegged.

You can only peg to *non-inventory items* for a sales order creating a direct ship purchase order or direct ship requisition and for a work order from PeopleSoft Maintenance Management. There will be peg chains in the pegging table for these items but you cannot maintain the pegs in the Pegging Workbench.

Understanding Peg Chains

The peg chain is maintained in the IN_PEGGING table. This table links the demand transaction to the supply transaction and includes the following fields:

- The **QTY_PEGGED** field, which stores the total pegged quantity between the demand and supply transactions. This quantity is in the standard unit of measure for the item.

- The *PEG_STATUS* field identifies the current state of the peg chain and includes the following values:
 - *Open*: (10) Indicates the line has a currently active peg.
 - *Completed*: (20) Indicates the peg chain is finished and the pegged supply has been received.
 - *Canceled*: (30) Indicates that either the pegged supply or pegged demand was canceled.
- The **QTY_RECEIVED** field, which stores the amount of the supply-side pegged quantity that has been received or completed. This quantity is in the standard unit of measure for the item.
- The **QTY_COMPLETE** field, which stores the amount of the supply-side pegged quantity that has been putaway into PeopleSoft Inventory. This quantity is in the standard unit of measure for the item.
- The **HARD_PEG** field is a yes/no field indicating a hard or soft peg.
- The **DMD_DTTM** field stores the schedule date of the demand transaction.
- The **SUP_DTTM** field stores the due date of the supply transaction.
- The **DMD_OPEN_QTY** field stores the order quantity of the demand transaction. This quantity is in the standard unit of measure for the item.
- The **SUP_OPEN_QTY** field stores the order quantity of the supply transaction. This quantity is in the standard unit of measure for the item.
- The **DEMAND_HASH** and **SUPPLY_HASH** fields identify the transactions that are pegged. The hash field can be converted to the order keys of the demand or supply transaction using the hash tables of the associated record. The hash tables and associated records are:
 - **IN_DEMAND_HASH** and **IN_DEMAND**: Demand fulfillment record in PeopleSoft Inventory.
 - **PO_HASH** and **PO_LINE_DISTRIB**: The purchase order distribution line record in PeopleSoft Purchasing.
 - **REQ_HASH** and **REQ_LN_DISTRIB**: The requisition distribution line record in PeopleSoft Purchasing.
 - **SF_OUTPUT_HASH** and **SF_OUTPUT_LIST**: The production ID line in PeopleSoft Manufacturing.
 - **WM_WO_PO_HASH** and **WM_WO_SCHED_PO**: For items to be ordered from PeopleSoft Purchasing, the work order task IDs resource line in PeopleSoft Maintenance Management.
 - **WM_WO_MAT_HASH** and **WM_WO_SCHED_MAT**: For items to be picked from PeopleSoft Inventory, the work order task IDs resource line in PeopleSoft Maintenance Management.

If a demand or supply date is changed, the system automatically updates the peg (including canceling the peg chain for canceled orders). If the peg is a hard peg and the user changes a demand date or quantity, the associated supply order itself is automatically changed as well. Optionally, notification can be sent to the relevant users (or user roles) that a change has taken place. Notifications are sent using the Message Dashboard. The setup for the Message Dashboard determines if the notification is logged on the dashboard, sent as an email and/or sent as a worklist entry in workflow.

Pegging in PeopleSoft Inventory

A material stock request in PeopleSoft Inventory can be used as the following order types for pegging:

- *Stock Request* (demand order type): material stock requests (MSR) shipping from an inventory business unit.
- *Transfer Demand* (demand order type): interunit transfers, a type of MSR, shipping from one inventory business unit to another inventory business unit.
- *Transfer Supply* (supply order type): interunit transfers, shipping from the sending inventory business unit is supply to the receiving inventory business unit.

Note: You can only peg a demand-side material stock request when the line is in an unfulfilled state and the item is a soft-reserve item.

You can access peg chains and create new peg chains by accessing the Pegging Workbench or view peg chains by accessing the Pegging Inquiry page from other PeopleSoft Inventory pages, including:

- Create/Update Stock Requests component
- Maintain Stock Requests component
- Shortage Workbench
- Stock Request inquiry page
- Fulfillment Status inquiry page
- Interunit Receipts page

Note: The link to the Pegging Workbench is only visible if the User Security page gives access to the user ID.

Pegging a Material Stock Request

You can peg a material stock request in PeopleSoft Inventory as the demand side of a peg. The stock request could be shipping to a customer, department, or another inventory business unit (demand-side interunit transfer).

This process flow diagram illustrates pegging material stock requests (demand) to an incoming interunit transfers (supply). The sequence of events in the process flow is explained below the diagram:

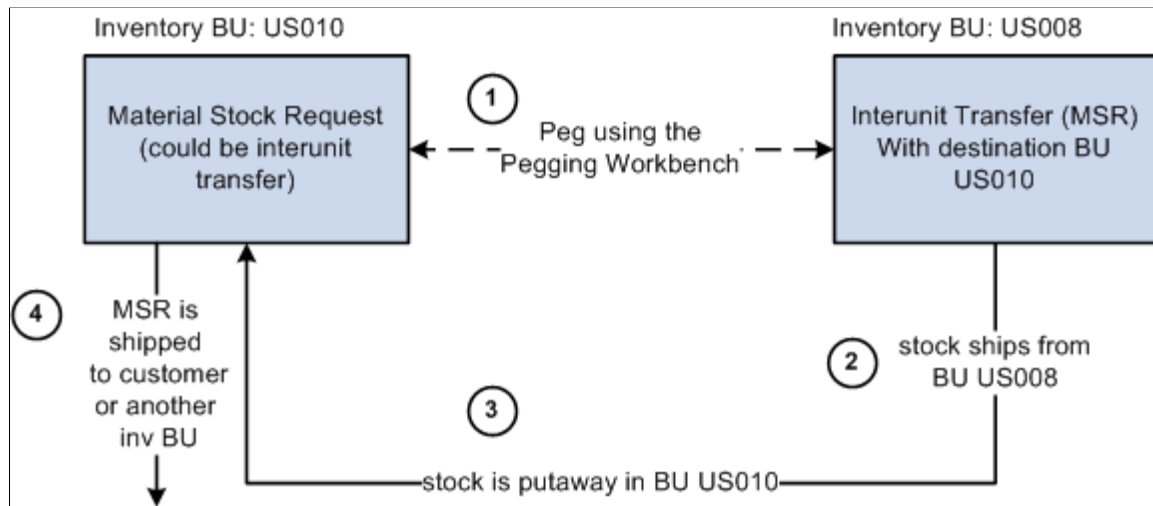

The sequence of events in the process flow when pegging an MSR to another MSR is:

1. Peg is created using the Pegging Workbench. A material stock request or an interunit transfer (demand-side) can be pegged to an interunit transfer (supply-side) with stock arriving in the business unit of the demand-side orders.
2. The supply-side interunit transfer is shipped from the sending business unit.
3. The supply-side interunit transfer is putaway in the destination business unit. During putaway, the stock is soft-reserved or optionally allocated to the outgoing material stock requests based on your setting in the pegging setup pages. In the IN_PEGGING table, if the pegged quantity (**QTY_PEGGED** field) is equal to the putaway pegged quantity (QTY_COMPLETE field) then the peg status in this table is updated to *complete*. If either the demand or supply order has no more open peg quantity, then the peg status on the order itself is also updated to *complete*.

If the notification framework has been defined for the Message Dashboard, then a notification is sent to the owner of the peg when putaway is complete.

4. The material stock request (demand-side) is fulfilled and shipped to the customer, department, or another inventory business unit.

This process flow diagram illustrates pegging material stock requests to a requisition or purchase order. The sequence of events in the process flow is explained below the diagram:

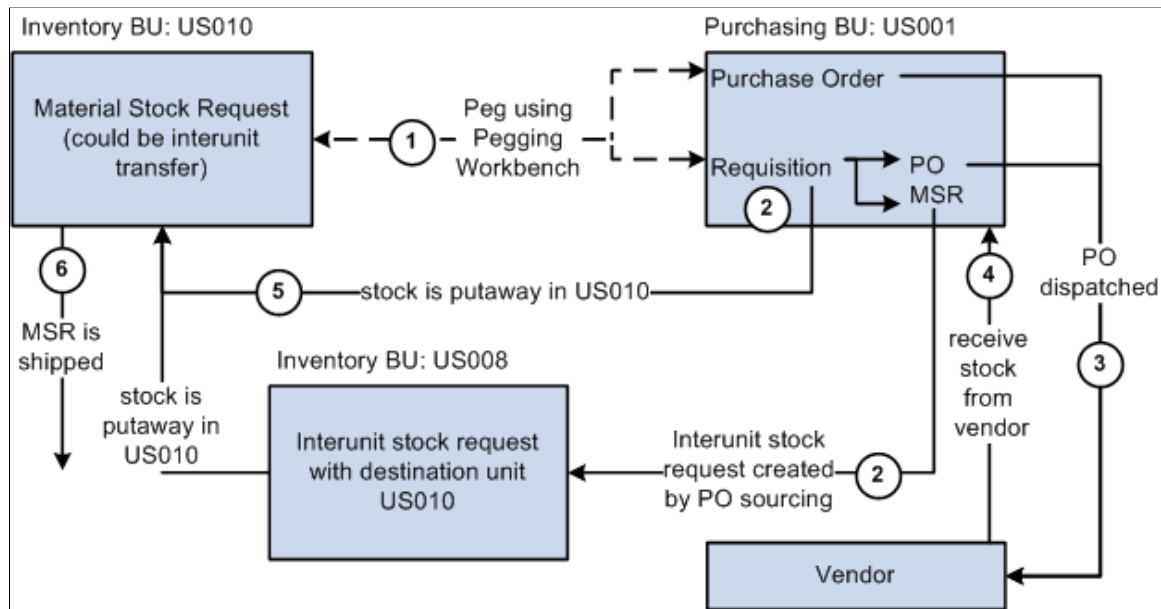

The sequence of events in the process flow when pegging an MSR to a requisition or purchase order is:

1. Peg is created using the Pegging Workbench. A material stock request can be pegged to a requisition or purchase order.
2. The requisition goes through the PO sourcing module and is sourced to an interunit stock request or a purchase order or both. The interunit stock request is created in the sending inventory business unit and is pegged to the MSR.
3. The purchase order is dispatched to the supplier.
4. The supplier ships the stock and it is received into the Purchasing business unit. If the notification framework has been defined for the Message Dashboard, then a notification is sent to the owner of the peg when stock is received into the Purchasing business unit.
5. The stock from the supplier or the sending inventory business unit is putaway in the inventory business unit. During putaway, the stock is soft-reserved or optionally allocated to the outgoing material stock requests based on your setting in the pegging setup pages. In the **IN_PEGGING** table, if the pegged quantity (**QTY_PEGGED** field) is equal to the putaway pegged quantity (**QTY_COMPLETE** field) then the peg status in this table is updated to *complete*. If either the demand or supply order has no more open peg quantity, then the peg status on the order itself is also updated to *complete*.

If the notification framework has been defined for the Message Dashboard, then a notification is sent to the owner of the peg when the stock completes putaway in the Inventory business unit.

6. The material stock request (demand-side) is fulfilled and shipped to the customer, department, or another inventory business unit.

This process flow diagram illustrates pegging an MSR to a production ID in PeopleSoft Manufacturing. The sequence of events in the process flow is explained below the diagram:

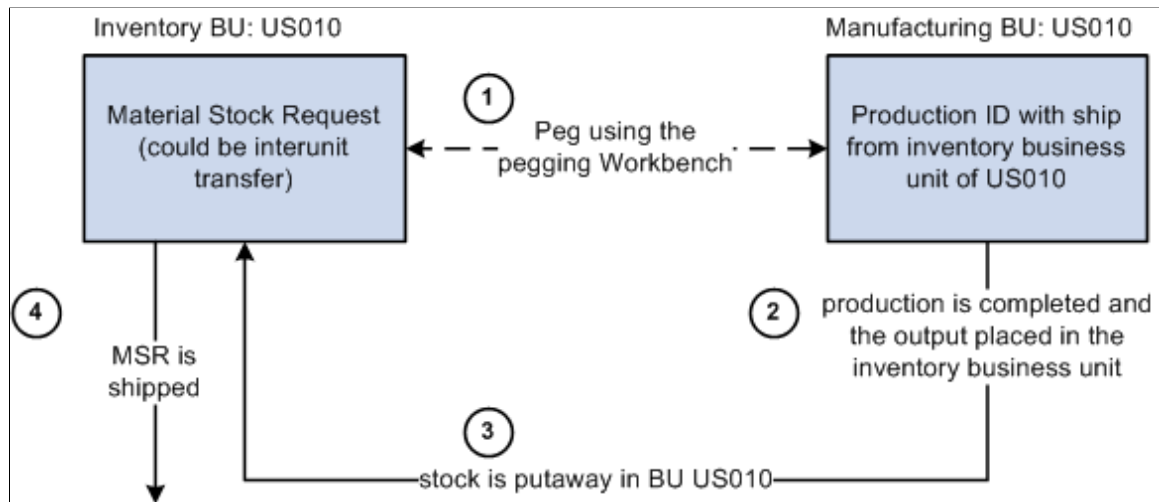

The sequence of events in the process flow when pegging an MSR to a production ID is:

1. Peg is created using the Pegging Workbench. A material stock request (demand) can be pegged to a production ID when the Manufacturing business unit is the same as the *Ship From* Inventory business unit. You can only peg to the primary output of a production ID.
2. The production is completed and the output placed in the inventory business unit.
3. During putaway, the stock is soft-reserved or optionally allocated to the outgoing material stock requests based on your setting in the pegging setup pages. Once the production order is closed the peg status is changed to *complete* on both the demand and supply transactions.

If the notification framework has been defined for the Message Dashboard, then a notification is sent to the owner of the peg when the stock completes putaway in the Inventory business unit.

4. The material stock request (demand-side) is fulfilled and shipped to the customer, department, or another inventory business unit.

Receiving Pegged Supply into PeopleSoft Inventory

Pegging links the stock coming into the PeopleSoft Inventory business unit to the outgoing orders. This peg prevents the incoming stock from being reserved or allocated to another order. For slow-moving items or customized orders, pegging enables you to keep inventory levels low and still deliver product efficiently to a customer. Pegging can also insure that customers get stock from the same lot or at a special cost.

Pegged supply can be received into a PeopleSoft Inventory business unit from an interunit transfer, a receipt from PeopleSoft Purchasing, or a completion from PeopleSoft Manufacturing. When the supply is received into the inventory business unit, it can be soft-reserved or hard-allocated to the demand line so that no other order can take the material. If the supply is received within the pegging lead days for the outgoing order (demand), then the stock can be placed in a default pegging putaway location so that it is easily found and shipped. In addition, the demand information is printed on the putaway plan.

When the pegged demand line is ready to be picked, the Order Release process attempts to pick from the default pegging putaway location first (unless the line is already allocated). If there is not enough stock

in the default location, the Order Release process picks the available stock and then picks the remaining quantity requested from the material storage locations selected by the standard picking method.

Load Staged Items Process

After the items slated for putaway have been inserted into the staging interface tables (STAGED_INF_INV and STGCOST_INF_INV), launch the Load Staged Items process to insert the items into the putaway staging tables (STAGED_ITEM_INV and STAGED_COST_INV). If the supply being putaway is pegged to a demand, then the Load Staged Items process associates the staged putaway to a specific demand and looks for a putaway location by:

1. Placing the stock in the material storage location specified on the putaway transaction or input by the user online.
2. If no location is specified on the putaway transaction or online, then the system determines if the pegged order (outgoing demand) is scheduled to ship within the pegging lead days window, if so the pegged supply quantity is received (putaway) into the default pegging location specified. If the pegged order is not within the pegging lead days window, the pegged supply quantity is received into the standard material storage location determined by the putaway processes.

If a default pegging putaway location is needed, the Load Staged Items process looks to the Default Putaway Locations page for a default pegging location defined by business unit and item ID. If none is found, the process looks to the Default Pegging Putaway Location Details page for a pegging location defined by inventory business unit.

One putaway (supply transaction) can be pegged to multiple demand transactions. If a partial receipt of the supply transaction is putaway, then the Load Stage Items process uses the Final Sort Option on the Setup Fulfillment component to determine how the incoming stock is applied to the demand transactions. For example, assume a purchase order with 100 units in total is pegged to one sales order (40 units pegged) and one material stock request (50 units pegged). A partial receipt of 30 units is received and putaway in the inventory business unit. The Load Staged Items process associates the staged putaway to a specific demand. In this case, the process determines how to associate the 30 units by using the Final Sort Option to prioritize the demand transactions.

Directed Putaway

If directed putaway is enabled for the inventory business unit, then the default pegging location is used for putaway of pegged supply following the same rules stated above for the Load Staged Items process. Capacity checking is ignored when placing stock in the default pegging location because it is assumed the shipment will occur in a short time frame. Directed putaway can be launched from a link on an online page. The following pages use default pegging locations during direct putaway:

- Interunit and RMA Receiving component. In addition, when receiving interunit transfers that are pegged supply, the InterUnit and RMA Receiving - Receipt Line page displays a link to the Pegging Inquiry component.
- Review Plan page
- Managing Receipts page in PeopleSoft eProcurement
- Maintain Receipts component in PeopleSoft Purchasing
- Record Completions and Scrap in PeopleSoft Manufacturing

Complete Putaway Process

The Complete Putaway process is the final stage in inventory putaway that updates the available quantity and inbound cost in the appropriate system tables. In addition, for pegged items, it can reserve or allocate the putaway quantity to an outgoing demand (materials stock request, interunit transfer, sales order, or work order). The Complete Putaway process performs a soft-reserve or hard-allocation based on your setting in the Pegging Setup page or the Pegging Item Setup page.

Once stock has been putaway in the inventory business unit, the Complete Putaway process:

1. Updates the putaway quantity (QTY_COMPLETE) in the IN_PEGGING record.
2. If all the pegged quantity has been received and putaway (QTY_COMPLETE=QTY_PEGGED), sets the peg status to *complete* in the IN_PEGGING record and in the supply and demand transactions.
3. If the notification framework has been defined for the Message Dashboard, sends a notification to the owner of the peg when putaway is complete.

See [Setting Up Notifications](#).

Reservations Processing

Pegged quantities can only exist in an *unfulfilled* demand line and are not moved to the *releasable* state until the peg is at least partially received. When the pegged supply is received and putaway in the inventory business unit, the peg status is changed to *complete*; enabling the demand line to be picked up by the Reserve Materials process and moved downstream. Keep in mind that the formerly-pegged quantity is reserved or allocated by the Complete Putaway process when the supply is putaway. Partial receipts do not set the peg status to *complete*.

When a demand line has both pegged and unpegged quantities, then the reservations process only attempts to reserve the unpegged portion of a demand line. For example, if a demand line has a total quantity of 10 units, and 4 are pegged, then the Reserve Materials process attempts to reserve the 6 unpegged units based on the reservation rules. If the unpegged portion of a demand line can be reserved and the peg portion is not yet complete, then the pegged portion is backordered and unpegged portion is reserved and set to releasable. The backorder rules determine if the pegged portion should be backordered or canceled. If a backorder is created, then the peg chain is updated to peg the backorder line to the incoming supply. When the supply comes in, the backorder line is fulfilled.

Picking and Shipping

The Order Release process sets the demand lines to the *released* fulfillment state for picking and generates the pick plan. For demand lines with a pegged quantity that was reserved during the Complete Putaway process, the Order Release process can now allocate stock from a specific material storage location. Allocation is optional. If you choose to create an allocation, the Order Release process attempts to find stock to allocate to a pegged quantity in:

1. The default pegging location defined on the Default Putaway Locations page for the inventory business unit and item ID combination.
2. If no location is specified on the Default Putaway Locations page or no stock is available in the location, then the system looks to the Default Pegging Putaway Location Details page to determine if a default pegging location has been specified for the inventory business unit.

3. If there is no default pegging location or no stock available in the location, then the system uses the picking method specified on the Order Release process page.

Keep in mind that pegged quantities that were allocated during the Complete Putaway process will keep that allocation when released for picking.

The system can ship order from the unfulfilled state using the Fulfillment Workbench, Front End Shipping process page, Shipping Request process page, the Front-End Shipping transaction, or the Shipping Transaction. These processes do not pick up and ship from the unfulfilled state when the demand line is fully or partially pegged (that is, the peg status is not complete).

Pegging in PeopleSoft Order Management

A sales order in PeopleSoft Order Management can be pegged as demand to the following supply order type; interunit transfers (supply-side) in PeopleSoft Inventory, production IDs from PeopleSoft Manufacturing, and requisitions or purchase orders from PeopleSoft Purchasing. Sales orders can use soft-pegs or hard-pegs. A peg for a sales order can be created using:

- The Alternate Sources of Supply page in PeopleSoft Order Management.

The Alternate Sources of Supply page enables you to create pegs, cancel pegs, change peg quantities, and view existing pegs. When needed, this page provides a link to the Pegging Workbench.

- The direct ship feature by selecting the Direct Ship from Supplier check box on the Order Entry Form in PeopleSoft Order Management. This check box is located in the Order Line Entry group box under the Ship Options 1 tab.
- The Requisition Loader (PO_REQLOAD) process or the Production Request (CPPIPRDN) process for a configured item on a sales order.

You can create new pegs and change existing peg chains for sales orders by using the Alternate Sources of Supply page in PeopleSoft Order Management. If the sales order schedule is pegged and has more than one demand line in the *unfulfilled* state, then the Alternate Sources of Supply page displays the **Change Quantity** link to take you to the Pegging Workbench.

Note: The link to the Pegging Workbench is only visible if the User Security page gives access to the user ID.

You can view peg chains for sales orders using the Sales Order Supply Source Detail page in PeopleSoft Order Management.

This process flow diagram illustrates pegging a sales order to a production ID. The sequence of events in the process flow is explained below the diagram:

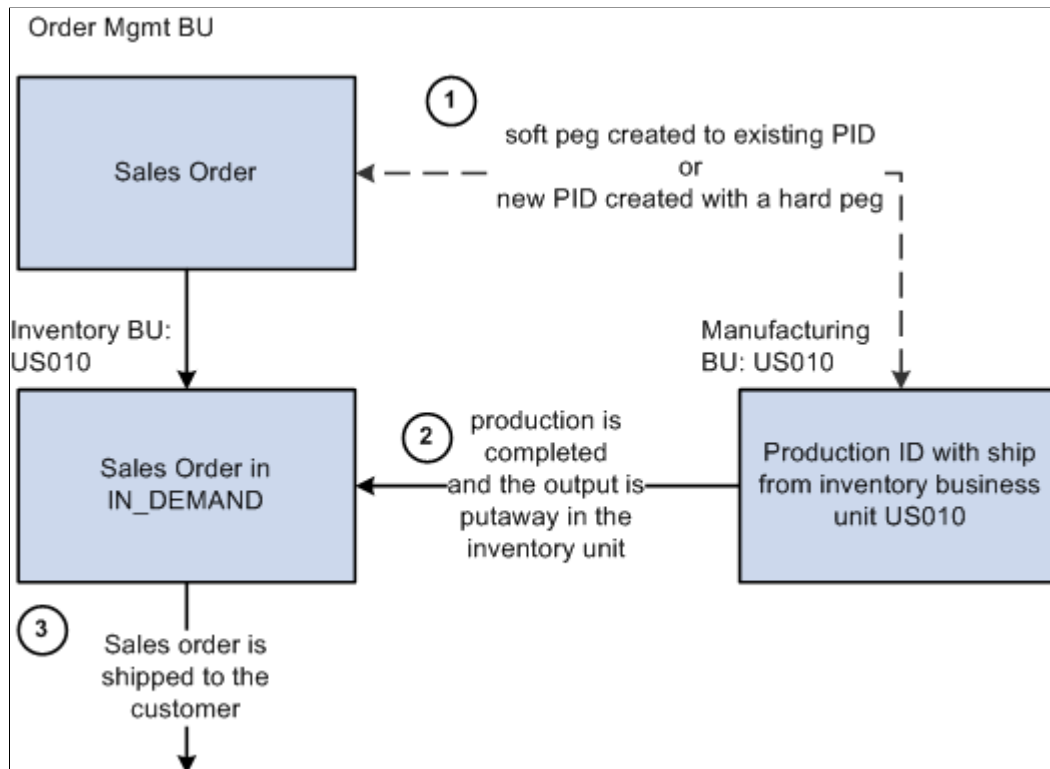

In this example, the PeopleSoft Manufacturing business unit of the production ID matches the *Ship From* Inventory business unit on the sales order; therefore, there is no interunit transfer.

Note: You can only peg to the primary output of a production ID.

The sequence of events in the process flow to peg a sales order to a production ID is:

1. Peg a sales order by using the Alternate Sources of Supply page in PeopleSoft Order Management to:
 - Create a *soft peg* between the sales order and an existing production ID.
 - Create a new production ID to fulfill the sales order. This is a *hard peg* between the sales order and production ID. The production ID is created when the sales order is saved. The Alternate Sources of Supply page uses the lead time fields located on the Define Business Unit Item - Manufacturing: General page to determine if the item can be manufactured in time to meet the scheduled shipment date. If the item can be manufactured in time, then a new production ID can be used as an alternate source.

When the sales order is saved it is inserted into the IN_DEMAND table in PeopleSoft Inventory.

2. The production is completed and the output placed in the inventory business unit. During putaway, the stock is soft-reserved or optionally allocated to the sales order. The peg status is changed to *complete* in the IN_PEGGING record and in the supply and demand transactions if either:
 - The production order is closed.
 - All the pegged quantity has been received and putaway (QTY_COMPLETE=QTY_PEGGED).

If the notification framework has been defined for the Message Dashboard, then a notification is sent to the owner of the peg when the stock completes putaway in the Inventory business unit.

3. The sales order is fulfilled in PeopleSoft Inventory and shipped to the customer.

This process flow diagram illustrates pegging a sales order to a production ID in PeopleSoft Manufacturing when the *ship from* inventory business unit is different between the sales order and the production ID. In other words, the stock is shipped to the customer from a different warehouse or distribution center than the manufacturing finished goods warehouse. The sequence of events in the process flow is explained below the diagram:

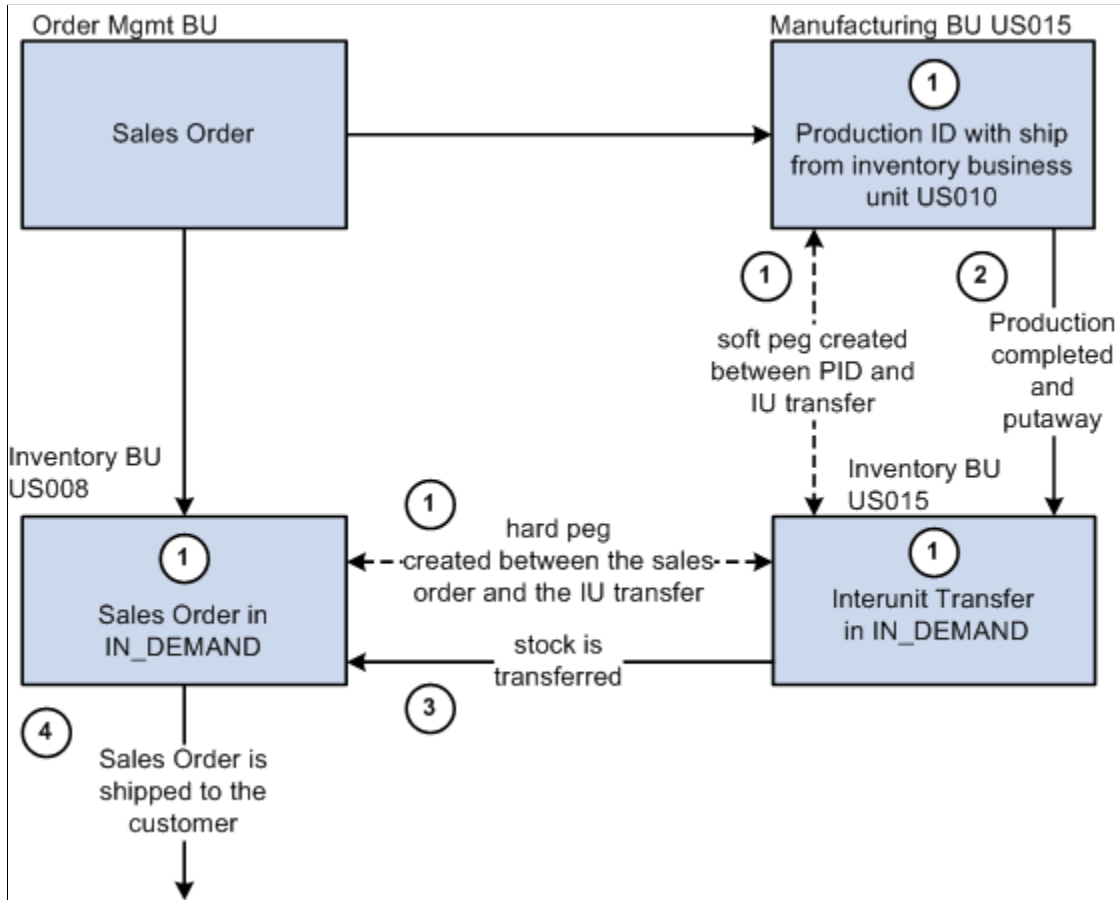

The sequence of events in the process flow to peg a sales order to a production ID when the *ship from* inventory business units are different between the demand and supply transactions is:

1. Use the Alternate Sources of Supply page in PeopleSoft Order Management to create and peg to a new production ID. When the sales order is saved, the PeopleSoft system:
 - Inserts the sales order into the IN_DEMAND table in PeopleSoft Inventory.
 - Creates a new production ID. The Alternate Sources of Supply page uses the lead time fields located on the Define Business Unit Item - Manufacturing: General page to determine if the item can be manufactured in time to meet the scheduled shipment date. If the item can be manufactured in time, then a new production ID can be used as an alternate source.

- Creates an interunit transfer (material stock request) to move the finished stock from the production IDs *ship from* inventory business unit to the sales order's *ship from* inventory business unit. This stock request is placed in the IN_DEMAND table in PeopleSoft Inventory.
 - Creates two pegs. One peg between the production ID and the interunit transfer and another peg between the interunit transfer and the sales order. These pegs are stored in IN_PEGGING and its related tables.
2. The production is completed and the output placed in the inventory business unit with the same name as the manufacturing business unit; this is the production IDs *ship from* inventory business unit. During putaway, the stock is reserved or allocated to the outgoing interunit transfer. The status of the first peg is changed to *complete* if either:
 - The production order is closed.
 - All the pegged quantity has been received and putaway (QTY_COMPLETE=QTY_PEGGED).
 3. The interunit transfer is used to ship the stock from the sending business unit to the destination business unit. When the stock is putaway in the sales order's *ship from* inventory business unit, the stock is reserved or allocated to the outgoing sales order. The status of the second peg is changed to *complete* in the IN_PEGGING record.
 4. The sales order is fulfilled and shipped to the customer.

Note: If the notification framework has been defined for the Message Dashboard, then a notification is sent to the owner of the peg when the stock completes putaway in the inventory business unit.

This process flow diagram illustrates pegging a sales order to an interunit transfer (supply). The sequence of events in the process flow is explained below the diagram:

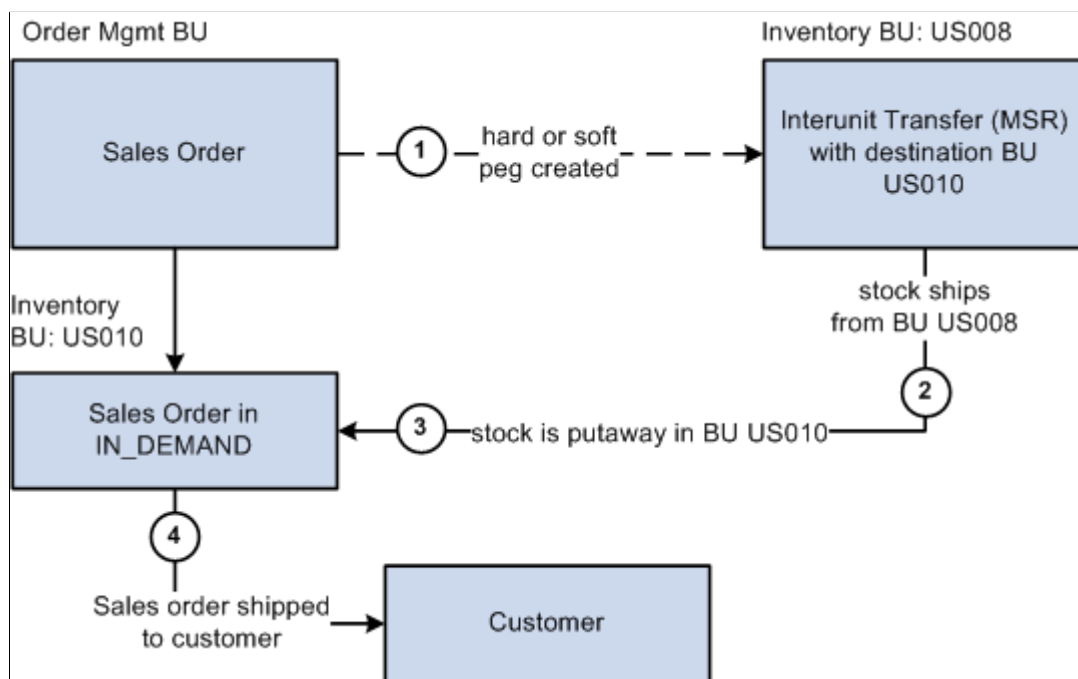

The sequence of events in the process flow to peg a sales order to an interunit transfer is:

1. Peg a sales order by using the Alternate Sources of Supply page to:
 - Create a *soft peg* between the sales order and an existing interunit transfer.
 - Create a new interunit transfer to fulfill the sales order. This is a *hard peg* between the sales order and interunit transfer. The interunit transfer (MSR) is created when the sales order is saved.

When the sales order is saved it is inserted into the IN_DEMAND table in PeopleSoft Inventory.

2. The supply-side interunit transfer is shipped from the sending business unit.
3. The supply-side interunit transfer is putaway in the destination business unit. During putaway, the stock is soft-reserved or optionally allocated to the outgoing sales order based on your setting in the pegging setup pages. In the IN_PEGGING table, if the pegged quantity (**QTY_PEGGED** field) is equal to the putaway pegged quantity (QTY_COMPLETE field) then the peg status in this table is updated to *complete*. If either the demand or supply order has no more open peg quantity, then the peg status on the order itself is also updated to *complete*.

If the notification framework has been defined for the Message Dashboard, then a notification is sent to the owner of the peg when the stock completes putaway in the inventory business unit.

4. The sales order is fulfilled and shipped to the customer.

This process flow diagram illustrates pegging a sales order to a requisition or purchase order. The sequence of events in the process flow is explained below the diagram:

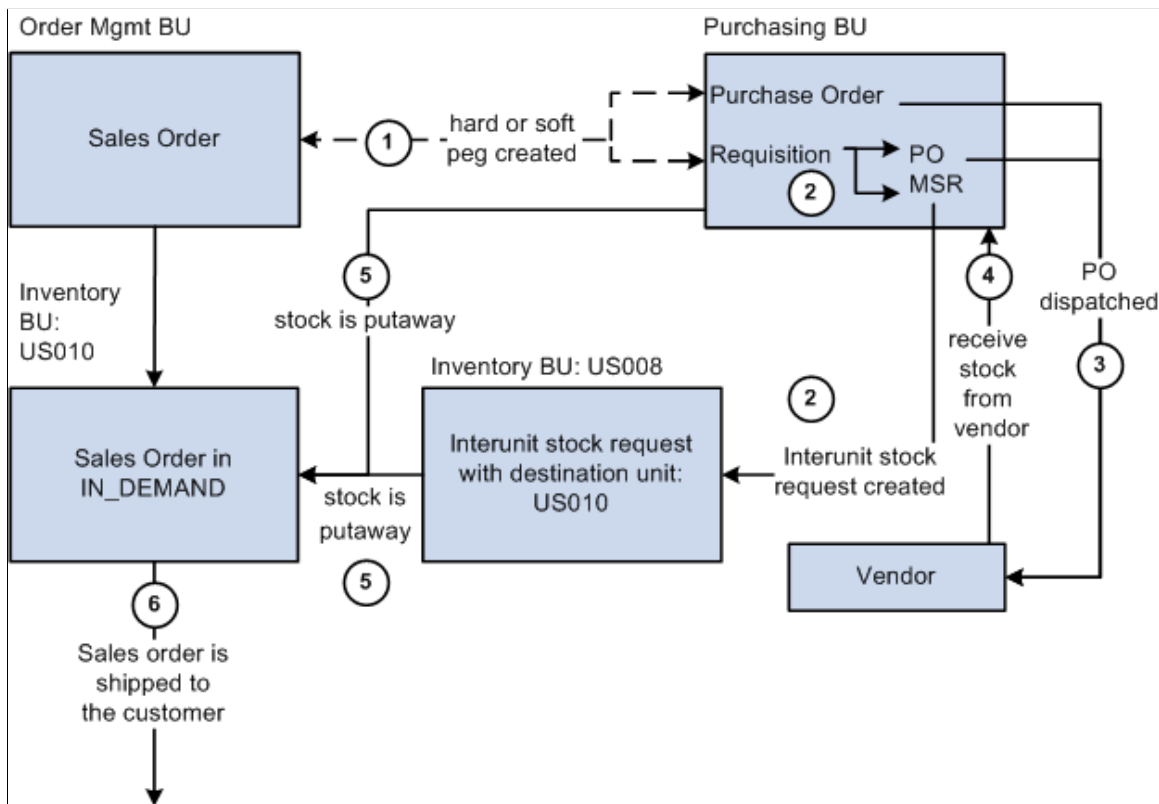

The sequence of events in the process flow when pegging a sales order to a requisition or purchase order is:

1. Peg a sales order by using the Alternate Sources of Supply page to:
 - Create a *soft peg* between the sales order and an existing requisition or purchase order.
 - Create a new requisition or purchase order to fulfill the sales order. This is a *hard peg*. The purchase order is created when the sales order is saved. The requisition is created by the Requisition Loader process.

When the sales order is saved it is inserted into the IN_DEMAND table in PeopleSoft Inventory.

2. If a requisition was created, it goes through the sourcing processes in PeopleSoft Purchasing and is sourced to an interunit stock request or a purchase order or both. The interunit stock request is created in the sending inventory business unit.
3. If a purchase order was created, it is dispatched to the vendor.
4. The supplier ships the stock and it is received into the purchasing business unit. If the notification framework has been defined for the Message Dashboard, then a notification is sent to the owner of the peg when stock is received into the purchasing business unit.
5. The stock from the supplier or the sending inventory business unit (or both) is putaway in the destination inventory business unit. During putaway, the stock is soft-reserved or optionally allocated to the outgoing sales order based on your setting in the pegging setup pages. In the IN_PEGGING table, if the pegged quantity (QTY_PEGGED field) is equal to the putaway pegged quantity (QTY_COMPLETE field) then the peg status in this table is updated to *complete*. If either the demand or supply order has no more open peg quantity, then the peg status on the order itself is also updated to *complete*.

If the notification framework has been defined for the Message Dashboard, then a notification is sent to the owner of the peg when the stock completes putaway in the inventory business unit.

6. The sales order is fulfilled and shipped to the customer.

This process flow diagram illustrates hard pegging a direct ship from supplier sales order to a requisition or purchase order. The sequence of events in the process flow is explained below the diagram:

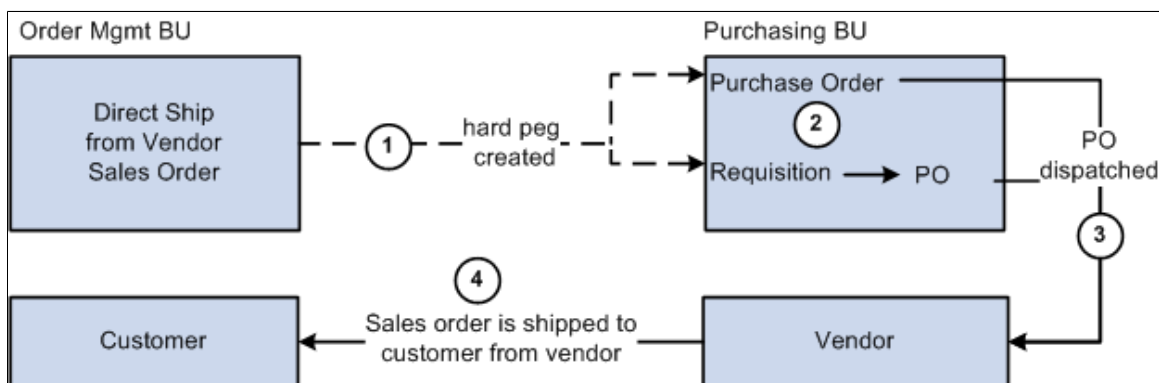

The sequence of events in the process flow for a direct ship from supplier sales order is:

1. Use the Alternate Sources of Supply page to create a new requisition or purchase order to fulfill the sales order. This is a *hard peg*. The purchase order is created when the sales order is saved. The requisition is created by the Requisition Loader process.

2. If a requisition was created, it goes through the sourcing processes in PeopleSoft Purchasing and is sourced to a purchase order.
3. The purchase order is dispatched to the supplier.
4. The supplier ships the stock directly to the customer.

This process flow diagram illustrates pegging a sales order with a configured product to a requisition in PeopleSoft Purchasing. The sequence of events in the process flow is explained below the diagram:

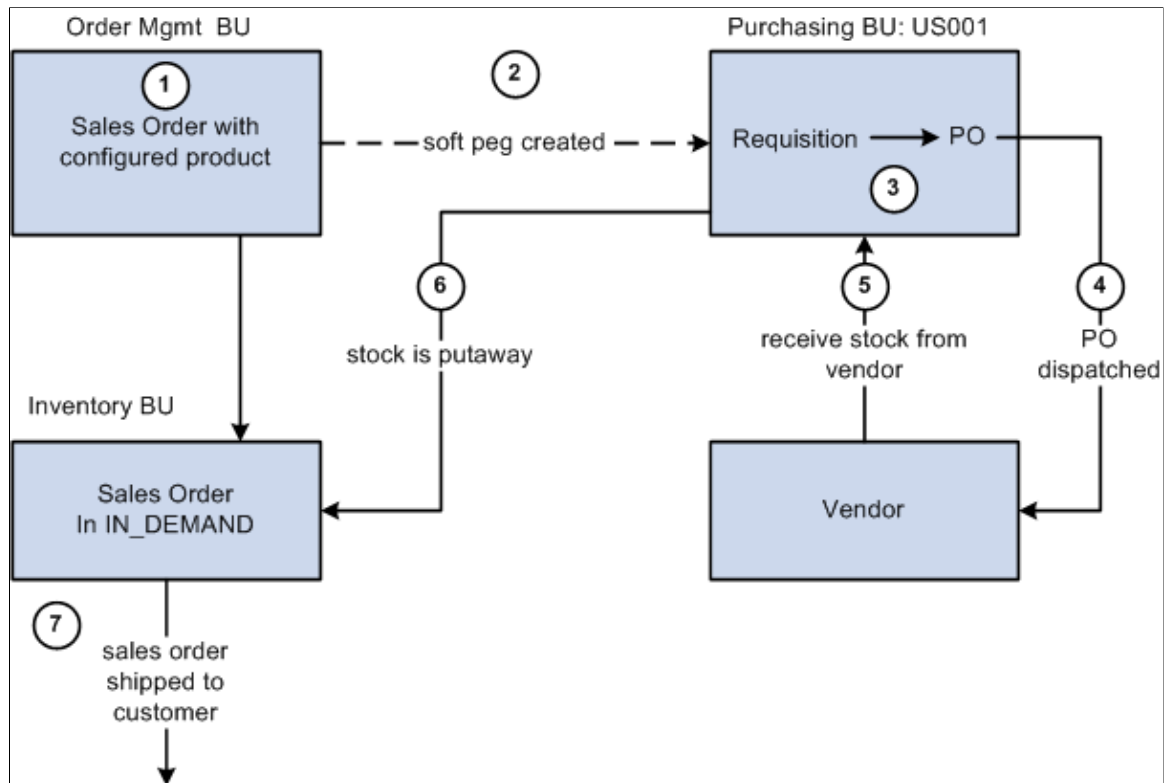

The sequence of events in the process flow for a configured product sourced from PeopleSoft Purchasing is:

1. A sales order with a configured product is created and saved. The demand line contains a configuration code generated by your PeopleSoft Product Configurator setup. This configuration code uniquely identifies the exact configuration for this product. The configured item is also lot-controlled. When the sales order is saved, it is inserted into the IN_DEMAND table in PeopleSoft Inventory.
2. The Requisition Loader process in PeopleSoft Purchasing, creates a requisition to fulfill the sales order. This requisition contains the configuration code. The Requisition Loader process also creates a soft peg between the sales order and the requisition. This soft peg is stored in IN_PEGGING and its related tables.
3. The requisition goes through the sourcing processes in PeopleSoft Purchasing and is sourced to a purchase order.
4. The purchase order is dispatched to the supplier.

5. The supplier ships the stock and it is received into the purchasing business unit. If the notification framework has been defined for the Message Dashboard, then a notification is sent to the owner of the peg when stock is received into the purchasing business unit.
6. The stock from the supplier is putaway in the inventory business unit. During putaway, the stock is lot-allocated to the outgoing sales order. Lot allocation reserves the incoming stock to the sales order at the business unit, item, lot, and storage location levels. In the IN_PEGGING table, if the pegged quantity (*QTY_PEGGED* field) is equal to the putaway pegged quantity (*QTY_COMPLETE* field) then the peg status in this table is updated to *complete*. If either the demand or supply order has no more open peg quantity, then the peg status on the order itself is also updated to *complete*.

If the notification framework has been defined for the Message Dashboard, then a notification is sent to the owner of the peg when the stock completes putaway in the inventory business unit.

7. The sales order is fulfilled and shipped to the customer.

This process flow diagram illustrates pegging a sales order with a configured product to a production ID in PeopleSoft Manufacturing when the *ship from* inventory business unit is the same on the sales order and the production ID. In other words, the stock is shipped to the customer from the manufacturing finished goods warehouse. The sequence of events in the process flow is explained below the diagram:

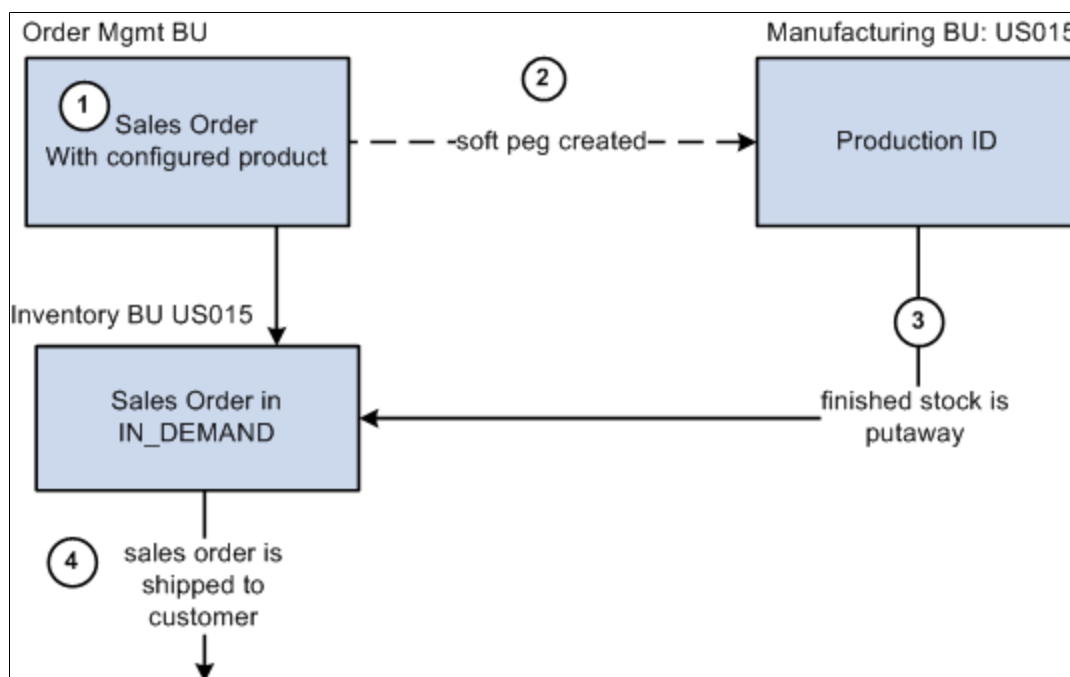

The sequence of events in the process flow for a sales order with a configured product to a production ID when the *ship from* inventory business unit is the same on both transactions is:

1. A sales order with a configured product is created and saved. The demand line contains a configuration code generated by your PeopleSoft Product Configurator setup. This configuration code uniquely identifies the exact configuration for this product. The configured item is also lot-controlled. When the sales order is saved, it is inserted into the IN_DEMAND table in PeopleSoft Inventory.
2. The Production Request process in PeopleSoft Product Configurator, creates a production ID to fulfill the sales order. This production ID in PeopleSoft Manufacturing contains the configuration code. The Production Request process also creates a soft peg between the sales order and the production ID. This soft peg is stored in IN_PEGGING and its related tables.

3. The production is completed and the output placed in the inventory business unit. During putaway, the stock is lot-allocated to the outgoing sales order. Lot allocation reserves the incoming stock to the sales order at the business-unit, item, lot, and storage location levels. The peg status is changed to *complete* in the IN_PEGGING record and in the supply and demand transactions if either:
 - The production order is closed.
 - All the pegged quantity has been received and putaway (QTY_COMPLETE=QTY_PEGGED).

If the notification framework has been defined for the Message Dashboard, then a notification is sent to the owner of the peg when the stock completes putaway in the inventory business unit.

4. The sales order is fulfilled and shipped to the customer.

This process flow diagram illustrates pegging a sales order with a configured product to a production ID in PeopleSoft Manufacturing when the *ship from* inventory business unit is different between the sales order and the production ID. In other words, the stock is shipped to the customer from a different warehouse or distribution center than the manufacturing finished goods warehouse. The sequence of events in the process flow is explained below the diagram:

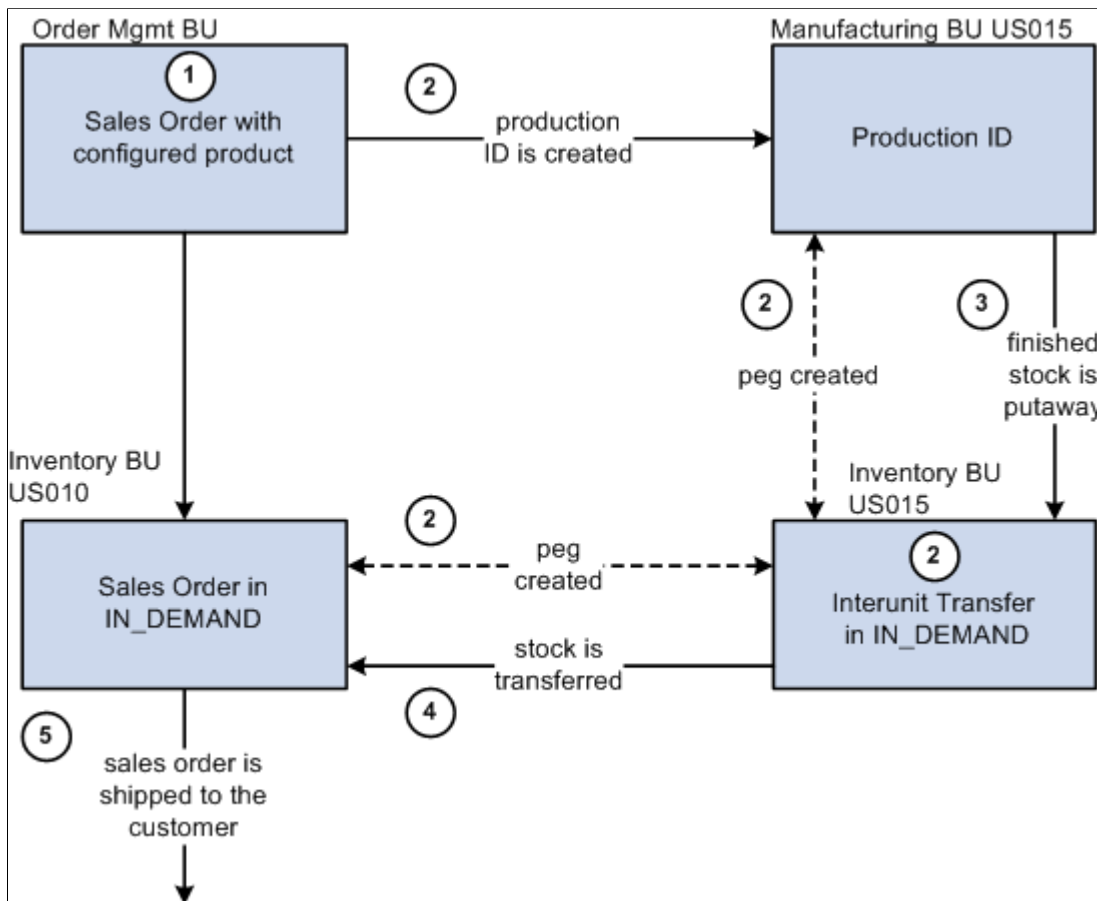

The sequence of events in the process flow for a sales order with a configured product to a production ID when the *ship from* inventory business units are different between the demand and supply transactions is:

1. A sales order with a configured product is created and saved. The demand line contains a configuration code generated by your PeopleSoft Product Configurator setup. This configuration code uniquely identifies the exact configuration for this product. The configured item is also lot-controlled.

When the sales order is saved, it is inserted into the IN_DEMAND table in PeopleSoft Inventory for the *ship from* inventory business unit on the sales order.

2. The Production Request process in PeopleSoft Product Configurator:
 - a. Creates a production ID to fulfill the sales order. This production ID in PeopleSoft Manufacturing contains the configuration code.
 - b. Creates an interunit transfer (material stock request) to move the finished stock from the production IDs *ship from* inventory business unit to the sales order's *ship from* inventory business unit. This stock request is placed in the IN_DEMAND table in PeopleSoft Inventory.
 - c. Creates two soft pegs. One peg between the production ID and the interunit transfer and another peg between the interunit transfer and the sales order. These soft pegs are stored in IN_PEGGING and its related tables.
3. The production is completed and the output placed in the inventory business unit with the same name as the manufacturing business unit; this is the production IDs *ship from* inventory business unit. During putaway, the stock is lot-allocated to the outgoing interunit transfer. Lot allocation reserves the incoming stock to the interunit transfer at the business-unit, item, lot, and storage location levels. The peg status is changed to *complete* if either:
 - The production order is closed.
 - All the pegged quantity has been received and putaway (QTY_COMPLETE=QTY_PEGGED).If the notification framework has been defined for the Message Dashboard, then a notification is sent to the owner of the peg when the stock completes putaway in the inventory business unit.
4. The interunit transfer is used to ship the stock from the sending business unit to the destination business unit. When the stock is putaway in the sales order's *ship from* inventory business unit, the stock is lot-allocated to the outgoing sales order. Lot allocation reserves the incoming stock to the sales order at the business-unit, item, lot, and storage location levels. The peg status is changed to *complete* in the IN_PEGGING record.
5. The sales order is fulfilled and shipped to the customer.

Related Links

"Understanding Alternate Sources of Supply" (PeopleSoft Order Management)

Pegging in PeopleSoft Maintenance Management

A work order in PeopleSoft Maintenance Management can be pegged as demand to an interunit transfers (supply-side) in PeopleSoft Inventory and requisitions or purchase orders from PeopleSoft Purchasing. Work orders can only use soft pegs. Pegged supply received and putaway in an inventory business unit can be reserved or allocated to the work order. If you are working with a non-inventory item ID or description-only item, then the method for pegging a work order differs from an order using an inventory ID.

A peg for a work order can be created using the:

- (inventory items only) Pegging Workbench.

The workbench displays work order tasks with inventory items to be pegged to. In addition, you can peg a requisition or purchase order to a work order task that you created on the workbench using the **Add Work Order Material** link.

- (inventory items only) Work Order-Schedules page in PeopleSoft Maintenance Management.
- Add/Update Requisitions component in PeopleSoft Purchasing.
- Add/Update POs component in PeopleSoft Purchasing.
- Add/Update Express POs component in PeopleSoft Purchasing.
- Create Requisitions component in PeopleSoft eProcurement.

You can access peg chains and create new peg chains by accessing the Pegging Workbench or view peg chains by accessing the Pegging Inquiry page from the Work Order - Schedules page in PeopleSoft Maintenance Management.

Note: The link to the Pegging Workbench is only visible if the User Security page gives access to the user ID.

Pegging a Work Order with an Inventory Item ID

This process flow diagram illustrates pegging a work order with an inventory item ID to an incoming interunit transfers. The sequence of events in the process flow is explained below the diagram:

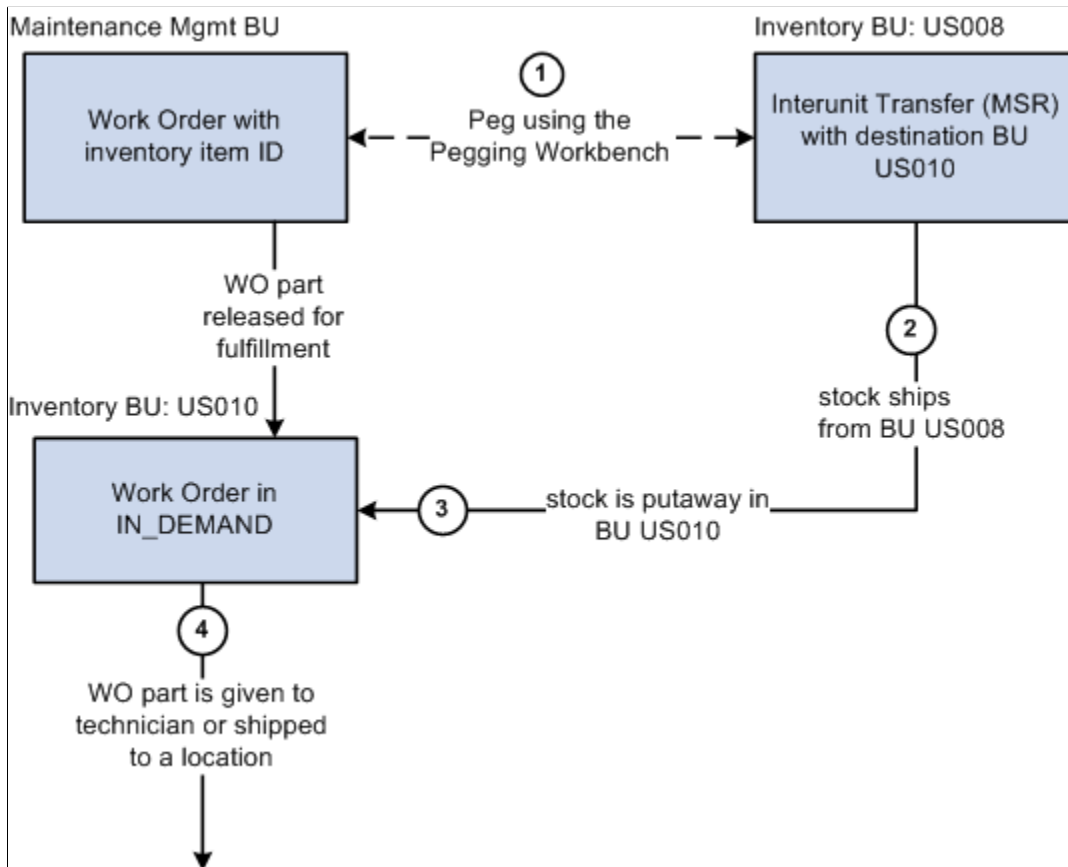

The sequence of events in the process flow when pegging a work order with an inventory item ID to an incoming interunit transfers is:

1. Peg is created using the Pegging Workbench. When a work order part is pegged, it is placed in the IN_DEMAND table for fulfillment, if it is not already there. The interunit transfer's destination business unit must match the work order's inventory business unit.
2. The supply-side interunit transfer is shipped from the sending business unit.
3. The supply-side interunit transfer is putaway in the destination business unit. During putaway, the stock can be soft-reserved or allocated. In the IN_PEGGING table, if the pegged quantity (QTY_PEGGED field) is equal to the putaway pegged quantity (QTY_COMPLETE field) then the peg status in this table is updated to *complete*. If either the demand or supply order has no more open peg quantity, then the peg status on the order itself is also updated to *complete*.

If the notification framework has been defined for the Message Dashboard, then a notification is sent to the owner of the peg when the stock completes putaway in the Inventory business unit.

4. The work order is fulfilled in PeopleSoft Inventory using the picking or issue features for work orders in the Fulfill Work Orders menu. The work order part is given to a technician or delivered to a location.

This process flow diagram illustrates pegging a work order with an inventory item ID to a requisition or purchase order. The sequence of events in the process flow is explained below the diagram:

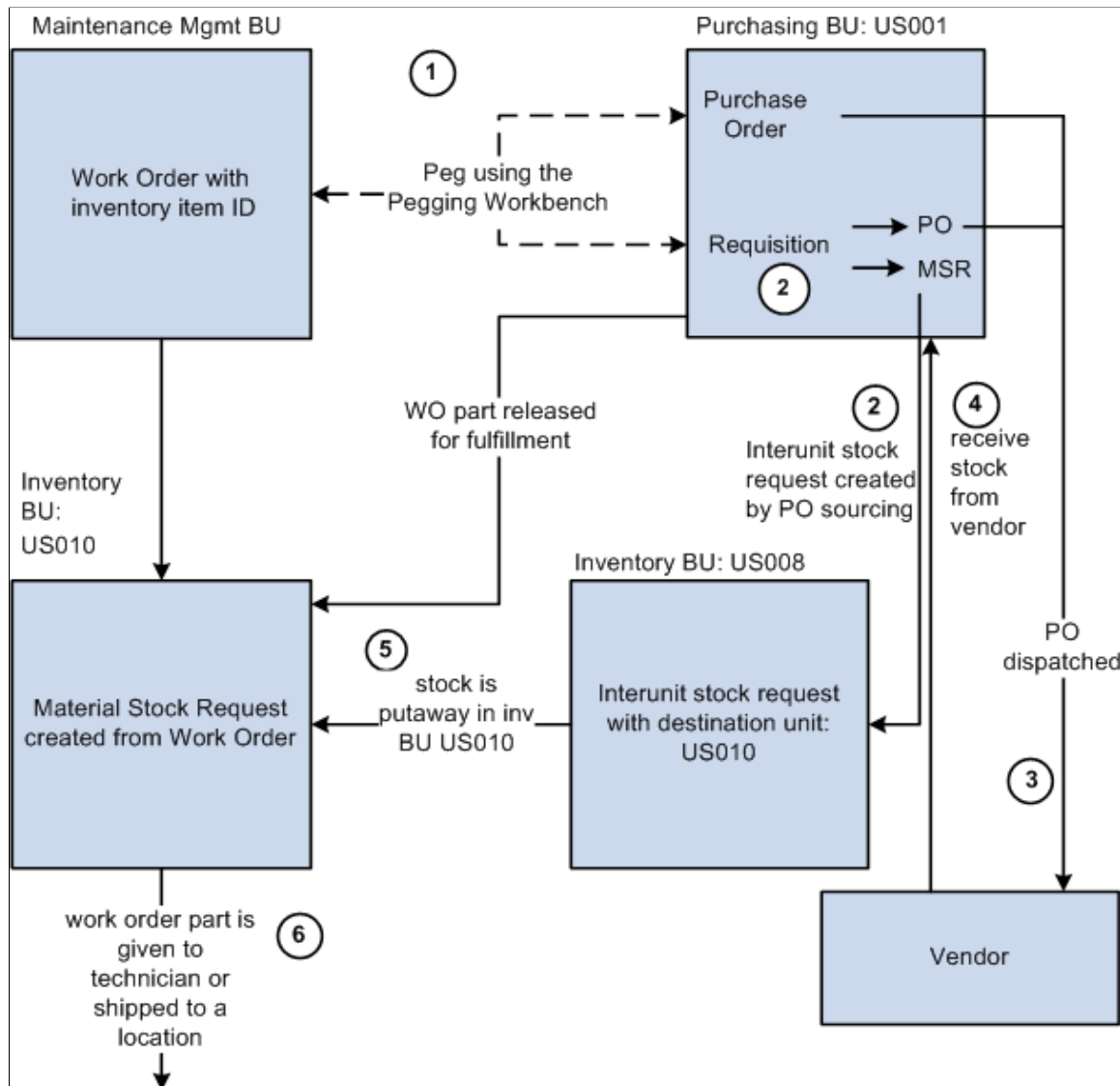

The sequence of events in the process flow when pegging a work order with an inventory item ID to a requisition or purchase order is:

1. Peg is created using the Pegging Workbench. When a work order part is pegged, it is placed in the IN_DEMAND table for fulfillment, if it is not already there. A work order is pegged to a requisition or purchase order.
2. The requisition goes through the PO sourcing module and is sourced to an interunit stock request or a purchase order or both. The interunit stock request is created in the sending inventory business unit.
3. The purchase order is dispatched to the supplier.
4. The supplier ships the stock and it is received into the Purchasing business unit. If the notification framework has been defined for the Message Dashboard, then a notification is sent to the owner of the peg when stock is received into the Purchasing business unit.

- The stock from the supplier or the sending inventory business unit is putaway in the destination inventory business unit. During putaway, the stock can be soft-reserved or allocated. In the IN_PEGGING table, if the pegged quantity (QTY_PEGGED field) is equal to the putaway pegged quantity (QTY_COMPLETE field) then the peg status in this table is updated to *complete*. If either the demand or supply order has no more open peg quantity, then the peg status on the order itself is also updated to *complete*.

If the notification framework has been defined for the Message Dashboard, then a notification is sent to the owner of the peg when the stock completes putaway in the Inventory business unit.

- The work order part is fulfilled in PeopleSoft Inventory using the picking or issue features for work orders in the Fulfill Work Orders menu. The work order part is given to a technician or delivered to a location.

Pegging a Work Order with a Non-Inventory Item

When using a non-inventory item ID or a description-only item on a work order line, you cannot peg to a materials stock request (interunit transfer, supply-side) or a production ID. You can peg to a requisition or purchase order. You can create the peg from the PeopleSoft Maintenance Management side or the PeopleSoft Purchasing side. The Pegging Workbench cannot be used to peg a non-inventory item ID or a description-only item. The Pegging Inquiry component can be used to view peg chains to non-inventory item ID or a description-only items.

This process flow diagram illustrates pegging, from PeopleSoft Maintenance Management, a work order that is using a non-inventory item ID or a description-only item. The sequence of events in the process flow is explained below the diagram:

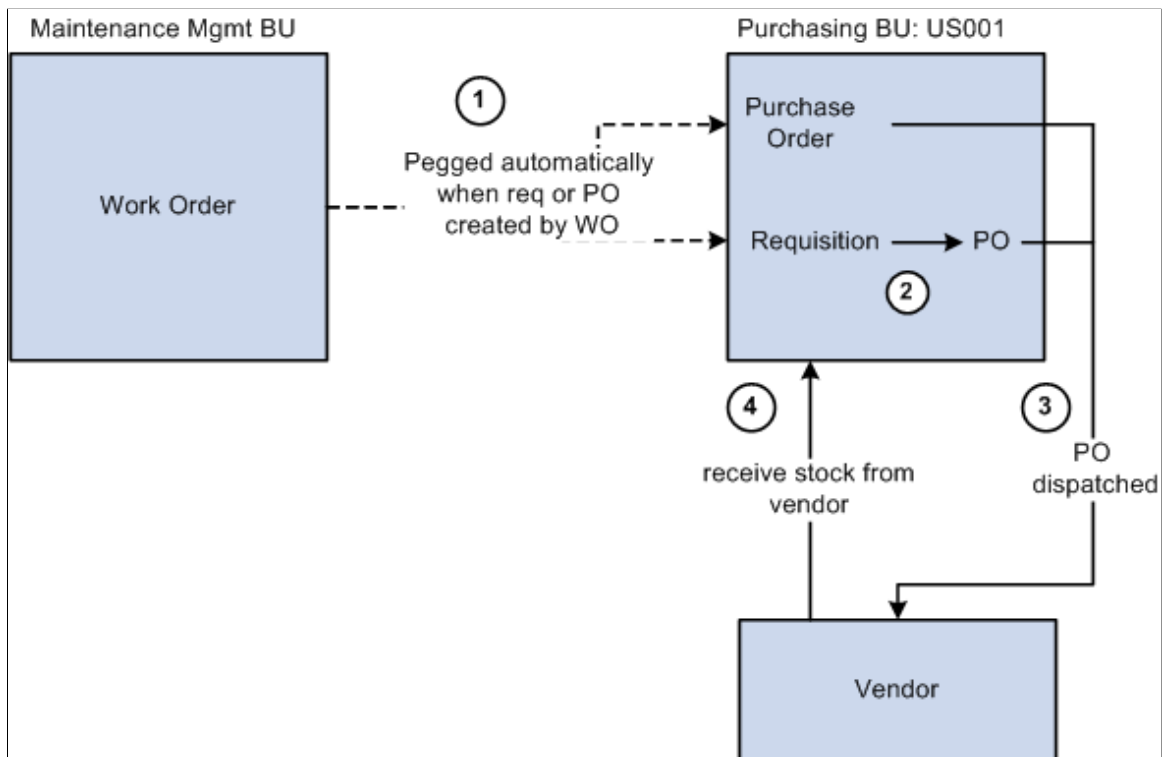

The sequence of events in the process flow is:

1. Using the Work Order - Schedules page, select the **Purchase/On-Hand** link, add a non-inventory item or description-only item, and then:
 - Click the **Load Requisition** button to place the work order line in a staging table where the Requisition Loader process will retrieve it and create a requisition in PeopleSoft Purchasing.
 - Click the **Load Purchase Order** button to place the work order line in a staging table where the Create Purchase Order process will retrieve it and create a purchase order in PeopleSoft Purchasing.
2. Use the sourcing module in PeopleSoft Purchasing to build a purchase order from the requisition. The requisition cannot be placed on a material stock request since there is no inventory item ID.
3. The purchase order is dispatched to the supplier.
4. If receiving is required, then the parts are received into the purchasing business unit. If receiving is not required, then the peg status is updated to *complete* when the purchase order is closed.

This process flow diagram illustrates pegging, from PeopleSoft Purchasing, a work order that using a non-inventory item ID or a description-only item. The sequence of events in the process flow is explained below the diagram:

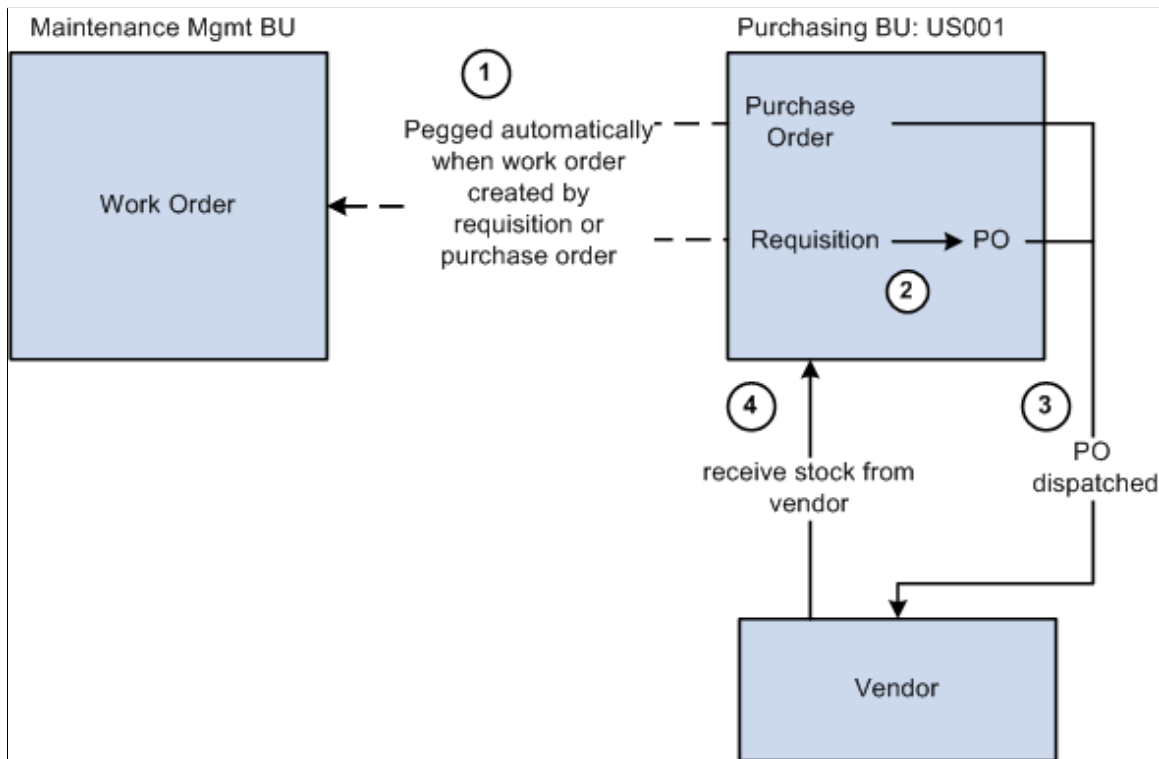

The sequence of events in the process flow when pegging from PeopleSoft Purchasing to a work order is:

1. Create a requisition or purchase order line:
 - In the Add/Update Requisitions component in PeopleSoft Purchasing, add a non-inventory item ID or a description-only item, select the Schedule button, select the Maintenance WO tab. Enter the Maintenance WO business unit, work order, task number, resource type, and resource line number. The work order ID and task must already exist in PeopleSoft Maintenance Management,

however the resource line number can be added here if needed. If the item does not exist on the work order and you want to add it, then leave the resource line number at zero. When the requisition is saved, a peg is automatically created between the requisition line and the work order.

- In the Add/Update Purchase Order component in PeopleSoft Purchasing, add a non-inventory item ID or a description-only item, select the Schedule button, select the Maintenance WO tab. Enter the Maintenance WO business unit, work order, task number, resource type, and resource line number. The work order ID and task must already exist in PeopleSoft Maintenance Management, however the resource line number can be added here if needed. If the item does not exist on the work order and you want to add it, then leave the resource line number at zero. When the purchase order is saved, a peg is automatically created between the purchase order line and the work order.
2. For a requisition, use the sourcing module in PeopleSoft Purchasing to source the requisition into a purchase order. The requisition cannot be placed on a material stock request since there is no inventory item ID.
 3. The purchase order is dispatched to the supplier.
 4. If receiving is required, then the parts are received into the purchasing business unit. If receiving is not required, then the peg status is updated to *complete* when the purchase order is closed.

Pegging in PeopleSoft Purchasing

A requisitions or purchase orders from PeopleSoft Purchasing can be pegged as supply to any demand order type: stock requests and transfer demand in PeopleSoft Inventory, sales orders in PeopleSoft Order Management, and work orders in PeopleSoft Maintenance Management.

A peg to a requisition or purchase order can be created using the:

- Pegging Workbench. With the workbench, you can create a soft peg to any demand order type.
- The schedule level of the Maintain Purchase Order component.
- The schedule level of the Maintain Requisitions component.
- The distribution level of the Express Purchase Order page.

You can access peg chains and create new peg chains by accessing the Pegging Workbench or view peg chains by accessing the Pegging Inquiry page from PeopleSoft Purchasing, including:

- The schedule level of the Maintain Purchase Order component.
- The schedule level of the Maintain Requisitions component.
- The Maintain Receipts - Receiving page.

Note: The link to the Pegging Workbench is only visible if the User Security page gives access to the user ID.

To view process flow diagrams about pegging requisitions and purchase orders, see the demand-side sections in this topic about pegging to PeopleSoft Inventory, Order Management, and Maintenance Management.

Related Links

[Pegging in PeopleSoft Inventory](#)

[Pegging in PeopleSoft Order Management](#)

[Pegging in PeopleSoft Maintenance Management](#)

Pegging in PeopleSoft Manufacturing

A production ID from PeopleSoft Manufacturing can be pegged as supply to stock requests and transfer demand in PeopleSoft Inventory and to sales orders in PeopleSoft Order Management. The following rules apply when pegging production:

- You can peg to a production ID but not a production schedule.
- You can only peg to the primary output of a production ID, not co-products or by-products.
- Once a production ID has been pegged, you cannot split it.

You can access peg chains and create new peg chains by accessing the Pegging Workbench or view peg chains by accessing the Pegging Inquiry page from the Maintain PIDs - Production ID Outputs page in PeopleSoft Manufacturing. In addition, you can access the Pegging Inquiry page from:

- Record Completions and Scrap component
- The PID/Schedule inquiry component
- The Review Dispatch List inquiry component

Note: The link to the Pegging Workbench is only visible if the User Security page gives access to the user ID.

Pegging chains are also visible on the Production report, Print Production documents and Dispatch List report.

To view process flow diagrams about pegging production IDs, see the demand-side sections in this topic about pegging to PeopleSoft Inventory and PeopleSoft Order Management.

Related Links

[Pegging in PeopleSoft Inventory](#)

[Pegging in PeopleSoft Order Management](#)

Setting Up Pegging

Pegging is set up at the Business-unit level, Item level, User level, Material storage location level, and Notification framework.

Pages Used to Set Up Pegging

Page Name	Definition Name	Usage
<u>Pegging Setup Page</u>	IN_PEG_SETUP	Define pegging attributes for the PeopleSoft Inventory business unit.
<u>Pegging Item Setup Page</u>	IN_PEG_IT_SETUP	Define pegging attributes for the item and business-unit combination. This page only needs to be used if the item varies from the business-unit level setup.
<u>User Security Page</u>	IN_PEG_USER_SEC	Based on the User ID, select the type of supply and demand that the user can work with.
Default Putaway Locations Page	DEFAULT_LOC_INV	Define a default material storage location to place pegged supply quantities when received into the inventory business unit. This pegging location is defined for the inventory business unit and item ID combination. You can establish material storage locations for both owned and non-owned stock putaways. The system uses this location if no material storage location is specified on the putaway transaction.
Default Pegging Putaway Location Details Page	DFLT_PEG_LOC_INV	Define a default material storage location to place pegged supply quantities when received into the inventory business unit. This pegging location is defined for the inventory business unit level. Both an owned and non-owned material storage location can be defined for a business unit. The system uses this location if no material storage location is specified on the Default Putaway Locations page.
Setup Fulfillment - Shipping Page	OF_SETUP6_INV	At the business-unit level, define the default pegging location as the picking material storage location for pegged orders.
Setup Item Fulfillment - Shipping Options Page	OF_SETUP_IT2_INV	At the item level, define the default pegging location as the picking material storage location for pegged orders.

Pegging Setup Page

To set up pegging attributes at the inventory business-unit level, use the Setup Pegging by Business Unit (IN_PEG_SETUP_GBL) component.

Use the Pegging Setup page (IN_PEG_SETUP) to define pegging attributes for the PeopleSoft Inventory business unit.

Navigation:

Inventory > Order Pegging > Business Unit Setup

This example illustrates the fields and controls on the Pegging Setup page. You can find definitions for the fields and controls later on this page.

Pegging Setup

Business Unit US010

Putaway

Peg Location Lead Days

Allocate Hard Pegs Allocate Soft Pegs

Workbench Detail Date Range

Starts days before the header scheduled date

To days after the header scheduled date

Field or Control	Description
Unit	Enter the Inventory business unit.
Peg Location Lead Days	Enter the number of lead days for pegged items in this inventory business unit. When the putaway processes receive pegged supply quantities, the peg location lead days are used to determine where to place the stock. The system adds the peg location lead days to today's date and compares the result to the scheduled ship date of the outgoing pegged demand order. If the order is within the lead days window, then the pegged supply quantity is received (putaway) into the pegged material storage location specified. If the order is not within the lead days window, the pegged supply quantity is received into the standard material storage location determined by the putaway processes.
Allocate Hard Pegs	<p>Select to allocate any hard-pegged receipts to the outgoing demand line at the time of putaway. A hard allocation reserves stock at a specific material storage location within the inventory business unit to satisfy an outgoing order line.</p> <p>Deselect this check box to reserve any hard-pegged receipts to the outgoing demand line at the time of putaway. A soft reservation reserves stock at the inventory business unit level to satisfy an outgoing order line. The specific material storage location for picking and shipping the stock is not reserved.</p>

Field or Control	Description
Allocate Soft Pegs	<p>Select to allocate any soft-pegged receipts to the outgoing demand line at the time of putaway. A hard allocation reserves stock at a specific material storage location within the inventory business unit to satisfy an outgoing order line</p> <p>Deselect this check box to reserve any soft-pegged receipts to the outgoing demand line at the time of putaway. A soft reservation reserves stock at the inventory business unit level to satisfy an outgoing order line. The specific material storage location for picking and shipping the stock is not reserved.</p>

Workbench Detail Date Range

Enter values to determine the time window displayed on the Pegging Workbench; this is used to limit the number of rows returned in the workbench search. These values only apply to unpegged supply or demand transactions.

Field or Control	Description
Starts	Enter the number of days prior to the demand line's scheduled shipment date or prior to the supply line's receipt date that should be displayed. The system subtracts the <i>Start days</i> from the demand or supply date and selects any supply/demand to be received/shipped within this window.
To	Enter the number of days past the demand line's scheduled shipment date or past the supply line's receipt date that should be displayed. The system adds the <i>To days</i> to the demand or supply date and selects any supply/demand to be received/shipped within this window.

Pegging Item Setup Page

To set up pegging attributes at the item level, use the Pegging Attributes by Item (IN_PEG_IT_SETUP_GBL) component.

Use the Pegging Item Setup page (IN_PEG_IT_SETUP) to define pegging attributes for the item and business-unit combination.

This page only needs to be used if the item varies from the business-unit level setup.

Navigation:

Inventory > Order Pegging > Item Setup

This example illustrates the fields and controls on the Pegging Item Setup page.

Pegging Item Setup

Business Unit US001

Item ID AM1000 **Laptop Computer**

Putaway

Peg Location Lead Days

Allocate Hard Pegs **Allocate Soft Pegs**

Workbench Detail Date Range

Starts **days before the header scheduled date**

To **days after the header scheduled date**

Define pegging attributes for a particular item ID to override the same attributes at the business-unit level.

For field definitions, see the *Defining Pegging Attributes for the Inventory Business Unit* section above.

See [Pegging Setup Page](#).

User Security Page

To set up user security for pegging, use the Pegging User Security (IN_PEG_USER_SEC_GBL) component.

Use the User Security page (IN_PEG_USER_SEC) to based on the User ID, select the type of supply and demand that the user can work with.

Navigation:

Inventory > Order Pegging > Pegging User Security

This example illustrates the fields and controls on the User Security page. You can find definitions for the fields and controls later on this page.

User Security

User ID VP1 Default Operator

Demand Order Type

<input checked="" type="checkbox"/> Sales Orders	<input checked="" type="checkbox"/> Stock Requests
<input checked="" type="checkbox"/> Work Orders	<input checked="" type="checkbox"/> Transfer Demand

Supply Order Type

<input checked="" type="checkbox"/> Purchase Orders	<input checked="" type="checkbox"/> Requisitions
<input checked="" type="checkbox"/> Production	<input checked="" type="checkbox"/> Transfer Supply

Peg QTY Putaway/Sourced

<input type="checkbox"/> Allow Change	<input checked="" type="checkbox"/> Deny Below Order Complete
---------------------------------------	---

This page enables you to set up pegging security by user. The user must be defined within the User Security page in order to peg demand or supply.

For each component where pegging is enabled, the system checks the user ID security setup. If the relevant order type is selected, then the system displays the link within that component. For example, if the user is in the Order Entry Form in PeopleSoft Order Management, the link **Peg to Demand** is available only if the Sales Orders check box has been selected for the user on the User Security page. In addition, once the link is taken, the Pegging Workbench filters the supply or demand based on the check boxes selected on the User Security page. For example, if a user can peg to all supply order types but production, then only purchase orders, requisitions, and interunit transfers would be available to peg to in the Pegging Workbench.

Demand Order Type

Select the demand side for pegging.

<i>Field or Control</i>	<i>Description</i>
Sales Orders	Select to enable this user ID to peg sales orders from PeopleSoft Order Management.
Stock Requests	Select to enable this user ID to peg stock requests in PeopleSoft Inventory.

Field or Control	Description
Work Orders	Select to enable this user ID to peg work orders from PeopleSoft Maintenance Management.
Transfer Demand	Select to enable this user ID to peg the outgoing interunit stock requests. Interunit stock requests in PeopleSoft Inventory are used to transfer stock from one inventory business unit to another.

Supply Order Type

Select the supply side for pegging.

Field or Control	Description
Purchase Orders	Select to enable this user ID to peg to purchase orders in PeopleSoft Purchasing.
Requisitions	Select to enable this user ID to peg to requisitions in PeopleSoft Purchasing.
Production	Select to enable this user ID to peg to production IDs in PeopleSoft Manufacturing.
Transfer Supply	Select to enable this user ID to peg to interunit stock requests as incoming supply. Interunit stock requests in PeopleSoft Inventory are used to transfer stock from one inventory business unit to another.

Peg QTY Putaway/Sourced

System administrators determine which users can use the Pegging Workbench to correct input errors or reverse a peg completion. Use caution and limit the number of users who have this ability. For more information about correcting peg quantities, see the "Changing Peg Chains" section of this topic.

Field or Control	Description
Allow Change	Select this check box to enable the user to change the Peg Qty Putaway/Sourced field on the Pegging Workbench.

<i>Field or Control</i>	<i>Description</i>
Deny Below Order Complete	Select this check box to prevent the user from reducing the quantity in the Peg Putaway/Source field below the quantity that has already been completed on the supply transaction or demand transaction. This check box is only available if you have selected the Allow Change check box. This feature prevents the user from creating open pegged quantity that is linked to completed quantity, for example, opening peg quantity that is linked to quantity that has already been putaway.

See [Changing Peg Chains](#).

Setting Up the Putaway Location for Pegged Supply

When pegged supply arrives at the Inventory business unit for putaway, the system must decide where to place the stock. A separate material storage location can be defined to prevent pegged supply from combining with incoming supply available to fulfill other orders. You can establish default pegging locations for the putaway of both owned and non-owned stock.

Note: When choosing a default pegging location, the system prevents you from selecting a materials storage location that is defined as non-open, non-nettable, WIP, or cross-docked.

If the pegged order (outgoing demand) is scheduled to ship within the pegging lead days window, then the pegged supply quantity is received (putaway) into the default pegging location specified. If the pegged order is not within the pegging lead days window, the pegged supply quantity is received into the standard material storage location determined by the putaway processes.

When pegged supply is received into PeopleSoft Inventory, the putaway processes:

1. Places the stock in the material storage location specified on the putaway transaction.
2. If no location is specified on the putaway transaction, then the system looks to the Default Putaway Locations page to determine if a default pegging location has been specified for the inventory business unit and item ID combination.
3. If no location is specified on the Default Putaway Locations page, then the system looks to the Default Pegging Putaway Location Details page to determine if a default pegging location has been specified for the inventory business unit.

For demand lines with a pegged quantity that was reserved during the Complete Putaway process, the Order Release process can now allocate stock from a specific material storage location. If you choose to create an allocation, the Order Release process attempts to find stock to allocate to a pegged quantity in:

1. The default pegging location defined on the Default Putaway Locations page for the inventory business unit and item ID combination.
2. If no location is specified on the Default Putaway Locations page or no stock is available in the location, then the system looks to the Default Pegging Putaway Location Details page to determine if a default pegging location has been specified for the inventory business unit.

- If there is no default pegging location or no stock available in the location, then the system uses the picking method specified on the Order Release process page.

Keep in mind that pegged quantities that were allocated during the Complete Putaway process will keep that allocation when released for picking.

Related Links

"Default Putaway Locations Page" (PeopleSoft Inventory)

"Default Pegging Putaway Location Details Page" (PeopleSoft Inventory)

Setting Up Notifications

Both soft and hard pegs can send Message Dashboard notifications to interested parties when:

- Pegged supply is received into the purchasing business unit.
- Pegged supply completes putaway into the inventory business unit.
- The pegged orders are changed or canceled.

This is a critical step to monitoring your peg chains in your environment. To use Message Dashboard notifications, you must set up the system-level registry and the business-unit level registry for pegging notifications.

The Message Dashboard is a central place to view all information related to messages, warnings and errors that occur from batch or online processes. A user receives notification of a message through an email, a worklist, or XML format. The notification method contains a link to the message dashboard, so that the user can quickly view the message detail, and take action. The message dashboard provides potential actions, which make the decision making process easier for the user, or may redirect the user to other components within the system.

For pegging notifications using the Message Registry, the following process names do not use the user role or user ID defined in the BU-Level Notifications page or the System-Level Notifications page. Instead, these process names use the *owner* of the transaction, as follows:

Process Name	User Notified
OM_PEGGING	The customer service representative (CSR) located on the sales order.
WM_PEGGING	The lead person located on the work order.
PO_PEGGING	The buyer located on the purchase order.
REQ_PEGGING	The requester located on the requisition. If no requester is listed, then the system uses the user ID or user role listed on the BU-Level Notifications page or the System-Level Notifications page.

IN_PEGGING and PRDN_PEGGING process names use the user ID or user role defined on the BU-Level Notifications page or the System-Level Notifications page.

For all of the above pegging notifications:

- An online pegging notification sends an email and a worklist entry.
- A batch pegging notification sends a batch email and no worklist entry.

Pegging Notifications in PeopleSoft Manufacturing

The pegging notifications for production IDs in PeopleSoft Manufacturing have an additional setting on the MFG Business Unit Options page. The **Compl and Close Peg Qty Change** group box controls how often notifications are sent to a production ID. This group box controls how often pegging notifications are sent to a user or group of users when changes are made on a production ID. PeopleSoft Manufacturing has a number of common circumstances that could cause excessive pegging notifications to be generated. For example, normal scrap activity during the completions process could result in quantity reduction notifications. Completing serial controlled items would generate a receipt notification for every serialized item. The close process generates close notifications for every order closed. PeopleSoft Manufacturing offers three options for controlling the number of pegging notifications generated during the completions and close processes:

- *Notify at Compl and Close*: Enables all normal pegging notifications including order quantity changes and closing of production.
- *Notify at Close*: Enables normal notifications in the production close process and prevents order quantity change notifications during completions.
- *No Notify at Compl or Close*: Suppresses close notifications during the close process and suppresses quantity change notifications during completions.

Pegging Notification Process Flow

The following diagram illustrates the process flow for notifications from online pegging processes. The online process creates a message, which is automatically sent to the Message Dashboard. If notifications are enabled in the message at the business-unit level registry or the system-level registry, then the system notifies the appropriate person using an email or a worklist entry where a link is provided to take the individual to the message detail page of the Message Dashboard:

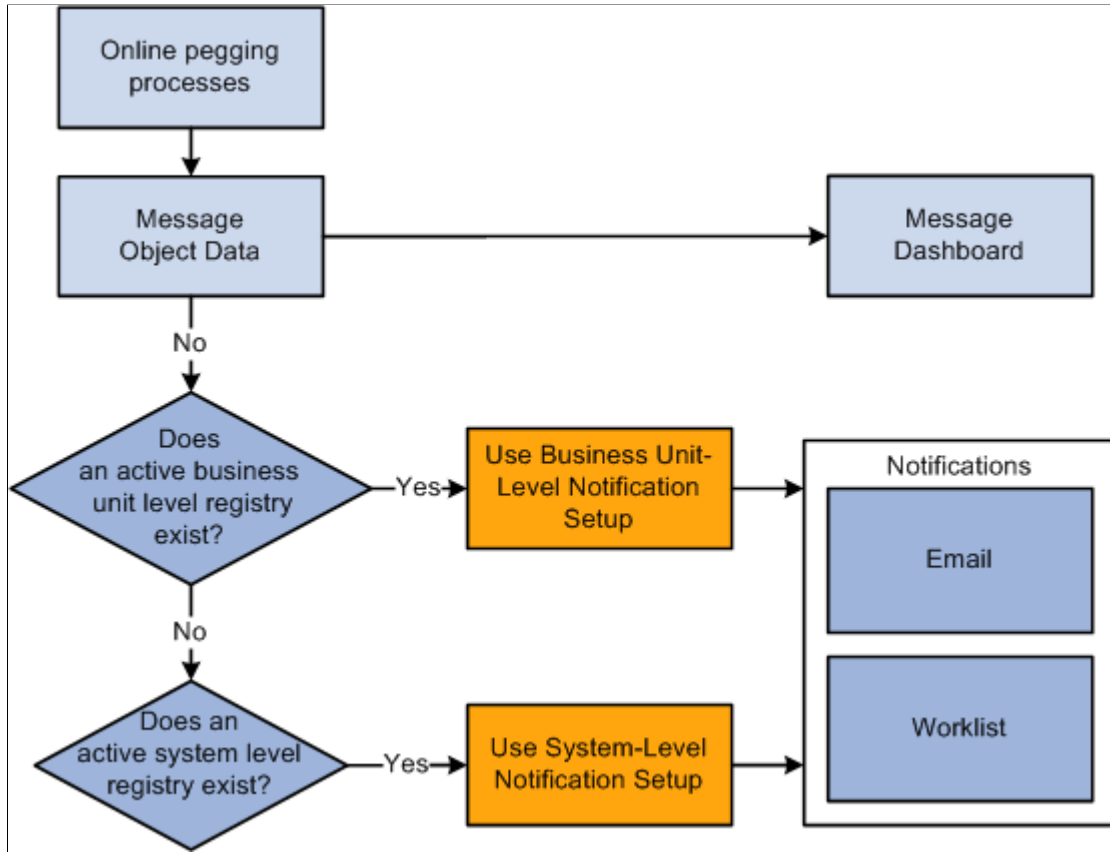

See the product documentation for *PeopleSoft Events and Notifications Framework*

Using the Pegging Workbench

The Pegging Workbench is used to create, change, or remove pegs. The workbench enables you to link a specific quantity from a demand to incoming supply. For example, 10 units of a soft-reserved item on an order's demand line can be pegged to 10 units on a purchase order line that contains 50 units. One demand line can be pegged to one or more supply-side lines. For example, 10 units of a soft-reserved item on an order's demand line can be pegged to 4 units on one purchase order and 6 units on another purchase order. In addition, you can peg the supply side to the demand side. One supply-side line can peg to one or more demand lines; for example, starting with a purchase order line with 50 units and pegging to a sales order that needs 10 units and then pegging to an MSR that needs 30 units.

The demand and supply lines that can be viewed and pegged using the Pegging Workbench are limited your pegging setup. Users can only access demand order types and supply order types defined for them in the User Security page. The Pegging Setup page and the Pegging Item Setup page can limit the time window of the Pegging Workbench for each user based on business unit or item. For example, a user may

be limited to the supply order type of purchase orders due within the next week. The pegging setup also has the additional benefit of limiting the number of supply or demand lines displayed on the Pegging Workbench, rather than showing all open demand and supply.

Note: A user cannot access the Pegging Workbench unless they have been defined on the User Security page.

The workbench can be accessed from several different pages throughout PeopleSoft.

In order to be displayed on the Pegging Workbench:

- All orders must have some amount of open quantity. In other words, they cannot have been fully completed.
- Material stock requests from PeopleSoft Inventory must be in the *unfulfilled* state, approved, and for soft-reserved items; including; interunit demand.
- Sales orders from PeopleSoft Order Management must be in the *unfulfilled* state, approved, and for soft-reserved items.
- Purchase orders from PeopleSoft Purchasing must have a distribution line status of *open* and the Inventory Business Unit field cannot be blank.
- Requisitions from PeopleSoft Purchasing must have a value in the Inventory Business Unit field.
- Production IDs from PeopleSoft Manufacturing must be in any status before *pending complete*. No production schedules can be pegged. Only the primary output of a production ID can be pegged; you cannot peg co-products or by-products.
- Transfer supply from PeopleSoft Inventory must be approved and in any state other than *pending* or *canceled*.

The Pegging Workbench does not display:

- Non-inventory items.
- Product kits; however, the kit component demand lines are displayed.
- Configured product kits.
- VMI (supplier managed inventory) items.
- Sales orders that are pegged to a *direct ship* purchase order or requisition.

Pages Used for the Pegging Workbench

Page Name	Definition Name	Usage
<u>Search - Pegging Workbench Page</u>	IN_PEG_SEARCH	Enter the search criteria for demand or supply to use on the Pegging Workbench.

Page Name	Definition Name	Usage
<u>Pegging Workbench Page</u>	IN_PEG_DETAIL	For an order, view the possible sources of supply or demand. Apply, change, or remove pegs to the order.
Work Order Material Page	IN_PEG_WO_ADD_SP	Add a work order resource to an existing work order task and create an automatic peg to it from a requisition or purchase order.

Search - Pegging Workbench Page

Use the Search - Pegging Workbench page (IN_PEG_SEARCH) to enter the search criteria for demand or supply to use on the Pegging Workbench.

Navigation:

Inventory > Order Pegging > Order Pegging Workbench

This example illustrates the fields and controls on the Search - Pegging Workbench page. You can find definitions for the fields and controls later on this page.

Search

Pegging Workbench

Enter search criteria and push the Search button. Click on a hyperlink to go to pegging details.

*Order Type <input type="text" value="Sales Order"/>	OM Unit <input type="text" value="US001"/>
Inventory Unit <input type="text"/>	Kit ID <input type="text"/>
Item ID <input type="text" value="10009"/>	Order Line <input type="text"/>
Order No <input type="text"/>	Demand Line <input type="text"/>
Schedule <input type="text"/>	From Date <input type="text" value="03/08/2000"/>
To Date <input type="text" value="03/06/2013"/>	Customer <input type="text"/>
Customer PO <input type="text"/>	Ship To <input type="text"/>
	Buy Agree ID <input type="text"/>

Search Personalize | Find | View All | First 1-5 of 5 Last

Order	Non-Inventory Items								
Inventory Business Unit	Item ID	Order Information**	Line**	Schedule Date	Kit ID	Order Quantity	QTY Pegged	Total QTY Reserved	QTY Received
US010	10009	US001/CEN0004	OM/1/1/1	08/02/00	Parent ID	12	0	0	0
US010	10009	US001/CEN0006	OM/4/1/2	08/02/00	Parent ID	12	0	0	0
US010	10009	US001/WES0001	OM/5/1/1	08/02/00	Parent ID	12	0	0	0
US011	10009	US001/DWS0004	OM/3/1/1	08/04/00	Parent ID	12	0	0	0
US011	10009	US001/DWS0005	OM/5/1/1	08/04/00	Parent ID	12	0	0	0

**Note: Order Information = Source Business Unit / Order Number
**Line Information = Source / Order Line / Schedule Line / Demand Line

Field or Control	Description
Order Type	<p>Select an order type to determine the demand or supply for pegging. The order type selected determines the search criteria fields displayed. Order types are:</p> <ul style="list-style-type: none"> • <i>Production:</i> (supply-side) Select to peg production IDs in PeopleSoft Manufacturing. This selection opens up the following search criteria fields: Production ID, Area (production area), Status (production status), and Type (production type). • <i>Purchase:</i> (supply-side) Select to peg purchase orders in PeopleSoft Purchasing. This selection opens up the following search criteria fields: PO Unit (PeopleSoft Purchasing business unit), Order No. (purchase order number), Order Line, Schedule, Distribution Line, Supplier ID, Supplier Location, Supplier Name, and Buyer. • <i>Requisition:</i> (supply-side) Select to peg requisitions in PeopleSoft Purchasing. This selection opens up the following search criteria fields: PO Unit (PeopleSoft Purchasing business unit), Order No. (requisition order number), Order Line, Schedule, Distribution Line, Supplier ID, Supplier Location, Supplier Name, Status (of the requisition), and Requester. • <i>Sales Order:</i> (demand-side) Select to peg sales orders in PeopleSoft Order Management. This selection opens up the following search criteria fields: OM Unit (order management business unit), Order No. (sales order number), Order Line, Schedule, Demand Line, Customer (Sold To customer), Ship To, Customer PO, Buy Agree ID (buying agreement ID). • <i>Stock Request:</i> (demand-side) Select to peg material stock requests in PeopleSoft Inventory. This selection opens up the following search criteria fields: Order No. (MSR order number), Order Line, Schedule, Demand Line, Customer, Ship To, Location, and Carrier ID. • <i>Transfer Demand:</i> (demand-side) Select to peg outgoing interunit stock requests shipping from the current inventory business unit to another inventory business unit. This selection opens up the following search criteria fields: Source Unit (originating inventory business unit), Destination Unit (receiving inventory business unit), Order No. (MSR order number), Order Line, Schedule, Demand Line, Location, and Carrier ID. • <i>Transfer Supply:</i> (supply-side) Select to peg incoming interunit stock requests that will be received into the current inventory business unit. This selection opens up the following search criteria fields: Destination Unit (receiving inventory business unit), Source Unit (originating inventory business unit), Order No. (MSR order number), Order Line, Schedule, Demand Line, Location, and Carrier ID. • <i>WO Inventory:</i> (demand-side) Select to peg work orders in PeopleSoft Maintenance Management. This selection

Field or Control	Description
	opens up the following search criteria fields: Work Order Unit (PeopleSoft Maintenance Management business unit), Work Order ID, Task Number, Line, Work Type, Service Group, and Shop.
Include Closed Orders	Select this check box to access pegs that have been completed. This check box only displays for users that have been granted the ability to change the Peg QTY Putaway/Sourced field using the pegging User Security page. For more information about correcting pegs, see the "Changing Peg Chains" section of this topic. See Changing Peg Chains .
Inventory Unit	Select the inventory business unit for pegging.
Item ID	Select an item ID for pegging.
Kit ID	Select a product kit ID to search for lines containing kit components. You cannot select configured product kits. This field displays for the following order types: <ul style="list-style-type: none"> • Sales Order • Stock Request • Transfer Demand • Transfer Supply

Field or Control	Description
From Date and To Date	Enter the date range for the scheduled shipment, arrival, or due dates.
Search	Select to activate the search based on your search criteria. Search results are displays at the bottom of the page in the Search group box.

Search

This group box displays a list of the lines (supply- or demand-side) that meet the search criteria entered above. Use this group box to select the line to peg. If the search results only return one row, the system takes you directly to the Details Pegging Workbench page.

Pegging Workbench Page

Use the Details - Pegging Workbench page (IN_PEG_DETAIL) to for an order, view the possible sources of supply or demand.

Apply, change, or remove pegs to the order.

Navigation:

Inventory > Order Pegging > Workbench. Select a row from the search results.

This example illustrates the fields and controls on the Details - Pegging Workbench page.

Details

Pegging Workbench

Enter peg quantities and push the Save button.

Order Type Sales Order Inventory Unit US010
 Unit US001 Order No CEN1131
 Order Line 1 Schedule 1 Demand Line 1
 Item ID 10010
 Schedule Date 01/13/2014 QTY Order 2.0000 EA
 From Date 01/08/2014 Total QTY Reserved
 To Date 01/18/2014 Pegged Quantity 2.0000
 Peg Remaining 0.0000

Hide Other Fully Pegged Orders

Return to Search

Details Personalize | Find | View All | | | First 1 of 1 Last

Order Type	Order Information	Line	Schedule Date	Hard Peg	QTY Available Remaining	QTY Pegged	Open QTY Pegged
Purchase	US001/0000000253	1/1/1	01/13/2014	<input checked="" type="checkbox"/>	10.0000	2.0000	<input type="text" value="2.0000"/>

This example illustrates the fields and controls on the Quantity tab of the Details - Pegging Workbench page. You can find definitions for the fields and controls later on this page.

Details Personalize | Find | View All | | | First 1 of 1 Last

Order Type	Order Information	Line	Pegged QTY Received	Pegged QTY Putaway/Sourced	Total QTY Putaway/Sourced
Purchase	US001/0000000253	1/1/1	0.0000	0.0000	0.0000

The top part of this page displays information about the line (demand or supply) that you selected for pegging on the Search - Pegging Workbench page.

Field or Control	Description
Unit and Item ID	<p>Displays the inventory business unit and item ID of the line that you selected for pegging. The available orders to peg to that are displayed in the Details group box are filtered based on the inventory business unit and the item ID. For example, if a sales order with the item ID 10001 and inventory business unit US010 is displayed, then the Details group box will only display requisitions, purchase orders, production IDs, or incoming interunit stock requests (transfer supply) with the item ID 10001 and the destination inventory business unit US010. The same is true when pegging supply to demand. For example, if a purchase order with the item ID 10001 and inventory business unit US010 is displayed, then the Details group box will only display sales orders, stock requests, work orders, and transfer demand with the item ID 10001 and the destination inventory business unit US010.</p>
Kit ID	<p>If the line you have selected for pegging is part of a product kit, then this field displays the product kit ID. Select the product kit link to access the Kit Display page where you can view more information about the kit and all of the components.</p> <p>See "Kit Display Page" (PeopleSoft Inventory).</p>
From Date and To Date	<p>Displays the date range for the lines displayed in the Details group box. The initial date range is based on the Workbench Detail Date Range entered on the Pegging Item Setup page or the Pegging Setup page. You can change the dates to refine the displayed lines for pegging.</p>
Hide Other Fully Pegged Orders	<p>Select to remove fully pegged supply or demand from the displayed lines in the Details group box. The page will only list orders that have some unpegged quantity available; enabling you to focus on available quantities. For example, if a purchase order is fully pegged to one stock request, then it does not appear in the Details group box for any other stock requests if this box is checked. If you deselect the check box, then orders that are fully pegged to orders other than the header order appear in the Details group box, but they cannot be pegged. By viewing fully pegged orders with the item ID needed, you can identify orders that you might want to un-peg in order to get quantities for the current peg.</p>
QTY Order	<p>Displays the total quantity on the order. This includes quantities that were not pegged as well as pegged quantities.</p>
Pegged Quantity	<p>Displays the pegged quantity for the supply transaction or the demand transaction.</p>
Peg Remaining	<p>Displays the current quantity that can be pegged. The quantity is calculated as follows: QTY Order less Qty Reserved less Pegged Quantity plus Peg Completed Quantity.</p>

Field or Control	Description
Add Work Order Material	Use this link to access the Work Order Material page where you can add business unit, Work Order ID, and Task Number to add a work order part to an existing work order and create an automatic peg. This link only displays if you are pegging a requisition or purchase order.

Details

The **Details** group box displays the available orders that can be pegged to. If the top part of this page displays information about a demand line, then the Details section displays the supply (requisitions, purchase orders, production IDs, and transfer supply) available for pegging. If the top part of this page displays information about a supply-side line, then the Details section displays the demand (sales orders, stock requests, work orders, and transfer demand) available for pegging. Keep in mind that the demand and supply that can be viewed and pegged using the Pegging Workbench are limited by user ID on the User Security page.

If there was already quantity pegged to the demand or supply displayed on the top part of this page, then the system displays these pegged lines first and enables you to change the pegged quantity against that line or zero the quantity out to break the peg chain.

Field or Control	Description
Order Information	Displays the source business unit and order number. Select the line link to access an inquiry page with additional information about this order.
Line	Displays the order line, schedule line, and distribution (or demand) line.
Hard Peg	Indicates if the row has hard-pegged demand or supply. Hard pegs indicate that the existing peg has a one to one relationship between a demand line and a supply-side line. If you attempt to peg additional demand or supply quantities to this row, the system display a warning message that this action will change the peg to a soft peg. If you continue with the change, then the peg chain will be changed to a soft peg.
QTY Available Remaining	Displays the item quantity that is available to be pegged.
QTY Pegged	Displays the total pegged quantity of this line. Completions are not subtracted from this quantity.

Field or Control	Description
Open Qty Pegged	<p>Displays the total peg quantity less any completions. To create a peg, enter a quantity in this field to be pegged against the line that is displayed at the top of this page and then click the Save button. This creates the peg chains for the demand and supply. To break (remove) a peg, enter zero in this field and then click the Save button.</p>
Pegged QTY Received	<p>Displays the pegged quantity that has already been received or completed.</p> <hr/> <p>Note: This displayed quantity is not decrease for returned materials on RTV transactions.</p> <hr/>
Pegged QTY Putaway/Sourced	<p>Displays the pegged quantity that has already been putaway into a PeopleSoft Inventory business unit. If this is a requisition, then this field displays the quantity that has already been sourced to a purchase order or material stock request.</p> <p>This field is changeable if you have selected the Allow Change check box on the pegging User Security page. The ability to change this field helps you correct input errors or reverse completed pegs. For example, you would want to reduce this quantity if the receipt was entered in error or the incorrect quantity was received. Reducing this field automatically increases the Open QTY Pegged field by the same amount, thus reestablishing the peg between the purchase order (or production ID) and the demand-side transaction.</p> <p>If the Deny Below Order Complete check box is selected on the pegging User Security page, then you cannot reduce the amount in this field below the quantity that has been putaway in the PeopleSoft Inventory business unit. Since the pegging records are tied to the supply and demand transactions, you must first update these transactions. For more information about correcting pegs, see "Changing Peg Chains" section of this topic.</p> <hr/> <p>Note: The Pegged QTY Putaway/Sourced field is never changeable for a requisition.</p> <hr/> <p>See Changing Peg Chains.</p>

Field or Control	Description
Total QTY Putaway/Sourced	(supply-side only) Displays the total quantity of this line that has already been putaway into a PeopleSoft Inventory business unit. If this is a requisition, then this field displays the total quantity that has already been sourced to a purchase order or material stock request.

Note: All quantity fields use the standard unit of measure for the item ID.

Changing Peg Chains

From the Pegging Workbench and the transaction pages where pegs can be changed, a user can alter a peg chain by changing quantities, dates, items, or canceling orders. When a change is made by a user, the system calls the centralized peg chain update function to update the peg chain in the IN_PEGGING record and create any necessary notifications to the Message Dashboard. For hard pegs, the system also alters the supply-side transaction to conform to the change.

The notifications sent to the Message Dashboard are:

- For sales orders, sent to the sales order owner.
- For purchase orders, sent to the buyer.
- For all other order types, sent to the user defined in the System-Level Notifications page or the BU-Level Notifications page.

Note: For hard pegs, a supply-side transaction is only automatically updated when a change is made to the sales order.

The peg chain update function is called when the following changes occur:

- Changing the quantity, UOM, or schedule date of a demand or supply-side transaction. This includes sales orders with configured items.
- Canceling a demand or supply-side transaction.
- Changing the item ID or business unit on demand or supply-side transaction. This breaks the peg chain.

Changing Pegs After Receipt and Putaway of Supply

When the you receive supply that has been pegged, several updates occur:

1. For a pegged purchase order, you add or update the receipt in PeopleSoft Purchasing.
2. The stock is putaway into the PeopleSoft Inventory business unit using PeopleSoft processes that are launched manually or in the background.

3. In PeopleSoft Inventory, the received stock is automatically reserved and possibly allocated to the order (demand-side transaction).
4. The quantity complete on the peg record is automatically updated. If the peg quantity is fully satisfied, the peg status is changed to complete. The status is updated on the pegging record as well as the supply and demand records.

Once the above steps are complete, you may need to cancel the receipt of new stock due to user-error or returned goods. To reverse this putaway, the information needs to be updated on the supply transaction and the demand transaction as well as the pegging records.

To reverse the putaway of a receipt from PeopleSoft Purchasing, use the following steps:

1. If the incorrect receipt is discovered after the quantity has been putaway into PeopleSoft Inventory, then use Shortage Workbench to reduce the Planned Released Base quantity, using the action of Accept Override Quantity. This action removes the reservation and allocation of the quantity to the pegged order (demand-side transaction).
2. In PeopleSoft Purchasing, use the Maintain Receipts - Receiving page to cancel the receipt. Based on this cancellation, PeopleSoft processes decrease the quantity balance in the PeopleSoft Inventory business unit by reversing the original putaway transaction.
3. On the Details - Pegging Workbench page, change the Pegged QTY Putaway/Sourced field to reverse the receipt. This field can be edited if you have selected the Allow Change check box on the pegging User Security page. Reducing this field automatically increases the Open QTY Pegged field by the same amount, thus reestablishing the peg between the purchase order and the demand-side transaction.
4. When new stock is received for the pegged purchase order, create a new receipt. You might also choose to change the peg to use a different purchase order.

To reverse the putaway of a production ID, use the following steps:

1. Use Shortage Workbench to reduce the Planned Released Base quantity, using the action of Accept Override Quantity. This action removes the reservation and allocation of the quantity to the pegged order (demand-side transaction).
2. In PeopleSoft Manufacturing, use the Record Completions/Scrap page to record the negative completion and then run the putaway processes in PeopleSoft Inventory to decrease the quantity balance in the inventory business unit.
3. On the Details - Pegging Workbench page, change the Pegged QTY Putaway/Sourced field to reverse the putaway. Reducing this field automatically increases the Open QTY Pegged field by the same amount, thus reestablishing the peg between the production ID and the demand-side transaction.

Note: You cannot change the Pegged QTY Putaway/Sourced quantity field pegged to a requisition.

Monitoring Peg Chains

Use the Pegging Inquiry component and the Pegging Exception report to monitor pegs within your system.

Pages Used to Monitor Pegs

<i>Page Name</i>	<i>Definition Name</i>	<i>Usage</i>
<u>Search - Pegging Inquiry Page</u>	IN_PEG_SEARCH	Enter search criteria and select the demand or supply to review.
<u>Details - Pegging Inquiry Page</u>	IN_PEG_DETAIL	For an demand line or supply-side line, view all existing peg chains, including complete or canceled pegs. If there are any additional pegs against the lines displayed in the Details section, you can select the linked quantity to open another window and view the other peg chains.
<u>Pegging Exception Report Page</u>	IN_PEG_REP	Enter parameters and run the Pegging Exception Report (INS9095) process.

Search - Pegging Inquiry Page

Use the Search - Pegging Inquiry page (IN_PEG_SEARCH) to enter search criteria and select the demand or supply to review.

Navigation:

Inventory > Order Pegging > Pegged Order Inquiry

This example illustrates the fields and controls on the Search - Pegging Inquiry page. You can find definitions for the fields and controls later on this page.

Search

Pegging Inquiry

Enter search criteria and push the Search button. Click on a hyperlink to go to pegging details.

*Order Type <input type="text" value="Sales Order"/>	<input type="checkbox"/> Include Closed/Canceled Orders
Inventory Unit <input type="text"/>	OM Unit <input type="text" value="US001"/>
Item ID <input type="text"/>	Kit ID <input type="text"/>
Order No <input type="text" value="CEN1131"/>	Order Line <input type="text"/>
Schedule <input type="text"/>	Demand Line <input type="text"/>
From Date <input type="text"/>	To Date <input type="text"/>
Customer <input type="text"/>	Ship To <input type="text"/>
Customer PO <input type="text"/>	Buy Agree ID <input type="text"/>
Order Status <input type="text"/>	<input type="button" value="Search"/>

This page uses the same fields as the Search - Pegging Workbench page plus a few additional options.

Field or Control	Description
Order Type	<p>Select an order type for the peg chains to be viewed. The order type selected determines the search criteria fields displayed. This page includes all the order types that are used by the Search Pegging Workbench page plus one more option:</p> <p><i>WO Non-Inventory:</i> (demand-side) Select to view peg chains that link work orders in PeopleSoft Maintenance Management to non-inventory items on a requisition or purchase order in PeopleSoft Purchasing. This selection opens up the following search criteria fields: Work Order Unit (PeopleSoft Maintenance Management business unit), Work Order ID, Task Number, Line, Work Type, Service Group, and Shop.</p> <p>In addition, this page enables you to view sales orders with configured items that were pegged using the PeopleSoft Product Configurator setup. These pegs can be viewed but not changed.</p>
Include Closed/Canceled Orders	Select to search for orders with a closed or canceled status.

Related Links

[Search - Pegging Workbench Page](#)

Details - Pegging Inquiry Page

Use the Details - Pegging Inquiry page (IN_PEG_DETAIL) to for an demand line or supply-side line, view all existing peg chains, including complete or canceled pegs.

If there are any additional pegs against the lines displayed in the Details section, you can select the linked quantity to open another window and view the other peg chains.

Navigation:

Inventory > Order Pegging > Pegged Order Inquiry

Enter search criteria and select a line.

This example illustrates the fields and controls on the Details - Pegging Inquiry page. You can find definitions for the fields and controls later on this page.

Details

Pegging Inquiry

Order Type Sales Order	Inventory Unit US010	
Unit US001	Order No CEN1131	
Order Line 1	Schedule 1	Demand Line 1
Item ID 10010		
Schedule Date 01/13/2014		
	QTY Order 2.0000	EA
	Total QTY Reserved	
	Pegged Quantity 2.0000	
	Peg Remaining 0.0000	

[Return to Search](#)

Details Personalize | Find | View All | First 1 of 1 Last

Order	Quantity								
Order Type	Order Information	Line	Schedule Date	Peg Status	Hard Peg	QTY Available Remaining	QTY Pegged	Open QTY Pegged	
Purchase	US001/0000000253	1/1/1	01/13/2014	Open	<input checked="" type="checkbox"/>	10.0000	2.0000	2.0000	

This page uses the same fields as the Details - Pegging Workbench page, plus:

Field or Control	Description
Peg Status	<p>The PEG_STATUS field is located on the demand and supply-side transaction line and includes the following values:</p> <ul style="list-style-type: none"> • <i>Open (10)</i>: Indicates that the line has a currently active peg. • <i>Completed (20)</i>: Indicates that the pegged supply has been received and putaway into the PeopleSoft Inventory business unit. • <i>Canceled (30)</i>: Indicates that the peg chain was broken.

Related Links

[Pegging Workbench Page](#)

Pegging Exception Report Page

Use the Pegging Exception Report page (IN_PEG_REP) to enter parameters and run the Pegging Exception Report (INS9095) process.

Navigation:

Inventory > Order Pegging > Pegging Exception Report

This example illustrates the fields and controls on the Pegging Exception Report process page. You can find definitions for the fields and controls later on this page.

Pegging Exception Report

Run Control ID 1
Report Manager
Process Monitor
Run

Language English ▼

Process Request Parameters
Find | View All
First ◀ 1 of 1 ▶ Last

*Request ID PEGREPORT
+ -

Inventory Exceptions
 Non - Inventory Exceptions

Unit US001 🔍
Demand Unit

Report Options

Supply Date after Demand Date
 Previously Canceled Pegs
 Pegs with Available Quantity

Data Exceptions

[Return to Inventory](#)

<i>Field or Control</i>	<i>Description</i>
Inventory Exceptions	Select to include inventory items in the pegging exception report.
Unit	Enter the PeopleSoft Inventory business unit for inventory item pegging exceptions.
Non-Inventory Exceptions	Select to include non-inventory items used in work orders in the pegging exception report.
Demand Unit	Enter the business unit for PeopleSoft Maintenance Management.

Report Options

Select to produce the following reports:

<i>Field or Control</i>	<i>Description</i>
Supply Date after Demand Date	Select to produce a report of peg chains whose supply date is after the demand date; that is, the supply will come in too late to satisfy the demand.

Field or Control	Description
Data Exceptions	Select to produce a report of: <ul style="list-style-type: none"> • Peg chains where the supply or demand quantity is less than the pegged quantity. • Peg chains where the inventory business unit of the demand does not match the supply. • Incorrect pegged status, where orders have pegs but the peg status on the line is turned off and vice versa. • Canceled transactions with open pegs, where a transaction which has been canceled still has pegs remaining against it.
Previously Canceled Pegs	Select this check box to produce a report of peg chains where the supply or demand has been canceled. The system breaks the peg chain automatically when this happens.
Pegs with Available Quantity	Select this check box to produce a report of peg chains where open peg quantity exists and there is available quantity for the item currently in the inventory business unit that could be used to fulfill the demand line.

Implementing the Oracle Search Framework Search Engine

Understanding the Search Framework Search Engine

The Oracle Search Framework search engine enables requesters to search using synonyms and match cases. Also, you have the option to define price range and model as search fields. The Search Framework search engine can be used to access items from the PeopleSoft Item Master table or other item sources, including express catalog items. Once the items are indexed into the Search Framework collection, they can be searched and browsed for PeopleSoft eProcurement.

The Search Framework search engine consists of these components:

Term	Definition
Search Collection	<p>A collection is a language-specific directory or folder that contains multiple subdirectories. These subdirectories contain various kinds of files used by the Search Framework search engine during indexing and searching.</p> <hr/> <p>Note: These files are created based on a snapshot of the data in the specified record or field.</p> <hr/>
Search Field	<p>A field indexed into a search collection can be searched using word searching or comparison searching. For example, if you wanted to search on items priced less than \$20.00 USD, <i>Price</i> must be in the index as a field. The value indexed in an Search Framework field can be returned to an application using the Search Framework results framework.</p>
Zone	<p>A zone contains a group of words that are identified by a set of XML-like open and closed tags. For example, <DESCR> long sleeve shirt </DESCR>. A zone is indexed into the search collection for searching purposes only. Information indexed in a zone can't be returned to the calling application. Comparison searching cannot be done in a zone. Searching within a zone proceeds faster than when using fields.</p>
Data Object	<p>Defines the record relationships.</p>
Data Object Set	<p>A set of data objects that are related to each other with level and parent-child information.</p>

A collection is a group of fields that you set up that is used by the Search Framework search engine to index and assist users in their search for items. You define the fields for a requester to utilize in their search for items.

You can use either batch updates and rebuild, or incremental updates, to build search index collections. Searches are then performed against this collection. Items loaded from a CUP process can be indexed directly into the collection by selecting the **Index Items** check box, or by selecting PV_CUP_ITEMS as the data source on the Build eProcurement Search Collection page.

The search collection is built using the PeopleSoft Application Engine eProcurement Search Indexing process (PV_IDX_DATA), which is accessible from the Build Search Collection page. This process extracts data from the item catalog tables and writes a few intermediate text files: BIF files and DAT files. These files are indexed into the Search Framework collection, which is comprised of multiple file folders.

To implement the Search Framework search engine, use the Search Framework Search Indexing and the Maintain Search Framework Information components.

Note: These PeopleSoft applications utilize the Search Framework search engine: PeopleSoft eProcurement, PeopleSoft Order Management, and PeopleSoft Contracts. While much of the discussion in this topic relate to PeopleSoft eProcurement, you can apply the same concepts to the other applications.

See the product documentation for

PeopleTools: Search Technology

"Understanding Financials and Supply Chain Search" (Application Fundamentals)

Working with the Printable Documents Framework

Understanding the Printable Documents Framework

This section discusses:

- The Printable Documents Framework.
- The Printable Document Object.
- The Printable Document Object methods and properties.

The Printable Documents Framework

The Printable Documents Framework enables the creation of a real-time, printable document within the context of any online transaction. This printable version functionality is a common web feature that removes non-printable content from a web page (such as images, frames, buttons) for ease of printing. This framework removes the need to schedule a job to produce simple, straightforward transactional reports for printing. This printable version functionality supports these transactions:

- Counter sale goods receipt.
- Counter sale pick plan.
- Deposit refund.
- Cash drawer receipt.

If you want to add printable version functionality to any other online transaction in the system, you can leverage the Printable Document Object to assist you with this type of configuration.

Note: To view the goods receipt, pick plan, deposit receipts, and cash drawer receipts, you will need to grant full security access to the Web Libraries on your permission list for the iscripts located in the web library `WEBLIB_SCM_UTIL`. These iscripts are `HTMLAREA.FieldFormula.IScript_isPrintReady` and `HTMLAREA.FieldFormula.IScript_PrintDoc`.

See [Understanding BI Publisher Picking Plan and Goods Receipts Reports](#).

The Style Repository within the Printable Document Framework provides the ability to define the stylesheet to use with the Printable Document Framework reports. In addition, this repository allows you to customize the stylesheets and override a given stylesheet for reports at the business-unit level so that a different look and feel can be created for reports for each business unit.

Note: The Printable Document Style component is shipped as system data and should be updated by the developers adding reports to the Printable Document Framework. You populate the Printable Document Style By Business Unit component if you want to change the default stylesheet by business unit for a report within the Printable Document Framework.

The Printable Document Object

If you want to add printable version functionality to any other online transaction in the system, then you can leverage the Printable Document Object to assist you with this type of configuration.

To leverage the Printable Document Object within PeopleTools:

1. Add a translate value to the **SCM_REP_TYPE** field for your report.

This field is a CHAR(4) that contains the list of the valid SCM Reports for use with the SCM Printable Document Framework. These values are shipped for this field:

- *BICR* (Billing Cash Receipt)
- *BIDR* (Billing Deposit Receipt)
- *OMGR* (Order Management Goods Receipt)
- *OMPK* (Order Management Pick Plan)

2. Once you have added the translate value, you have these two options:

- Add the SAC_RPT_SUB subpage to your page at Level0.

This subpage contains an HTMLArea (DERIVED_HTML.HTMLAREA) that does not display any information to the user. Instead, this HTMLArea is used to pop up or print your printable document in the background by the Printable Document Framework.

- If you already have a HTMLArea on your page, you can omit the delivered subpage and simply assign the values returned by the PrintableDocument object properties showHTML or printHTML to the HTMLArea on your page.

3. Add PeopleCode to the page to create and display (or directly print) the printable document.

Note: This PeopleCode can be behind FieldChange on a pushbutton or link, behind RowInit, or anywhere that you can to initiate the Printable Document logic. This code is used for either launching a pop-up window that displays your printable document (showHTML) or for sending your printable document directly to a print dialog (printHTML).

Your PeopleCode must instantiate the PrintableDocument object (SCM_UTILITES:PrintableDocument) to generate a report. This PrintableDocument object accepts a rowset, an XML document, or a HTML string as valid data sources in order to generate a report. If you choose the rowset or XML document data source, then you must populate the XSLDocument property in order to translate the data into HTML for display. This XSLDocument can be populated directly or you can use the Print Document Framework Style Repository using the SetStyle() method to retrieve the report stylesheet. If the report data is already in HTML format, then no translation is needed and the XSLDocument property does not need to be set.

This figure illustrates the Printable Document Object Class:

This example illustrates the fields and controls on the Printable Document Object Class. You can find definitions for the fields and controls later on this page.

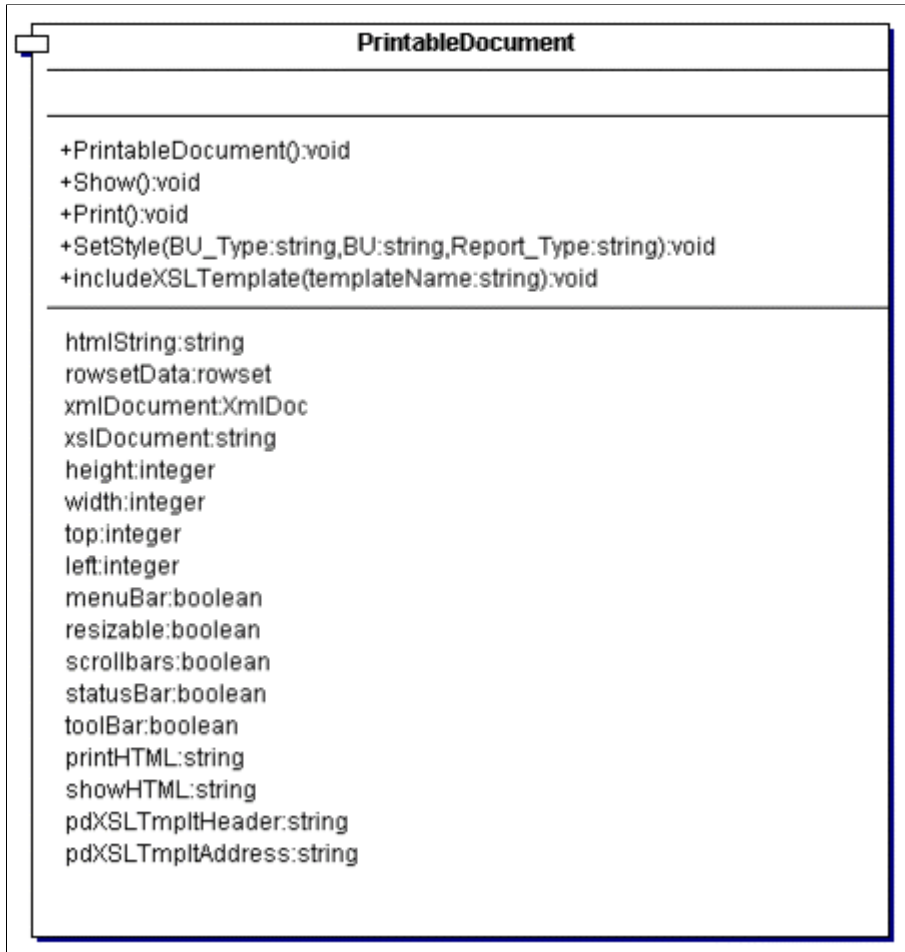

A sample PeopleCode instantiation of the Printable Document Object class might be:

```

/*Import the Printable Document*/
import SCM_Uutilities:PrintableDocument;

/*Instantiate the PrintableDocument Object*/
Local SCM_UTILITIES:PrintableDocument &pDoc;

/*Add code to create a local rowset withthe data needed for printing*/
Local Rowset &rs;
...
&pDoc.RowsetData=&rs;

/*Set the stylesheet*/
&pDoc.SetStyle("OM", "US001", "OMGR");

/*Show the Printable Document*/
&pDoc.Show();
  
```

Printable Document Object Methods and Properties

This section provides an overview of the methods and properties available for use with the Printable Document Object.

Methods

The Printable Document object has these methods that you can call:

Method	Use	Additional Information
Show ()	Use this method to display your report as a pop-up document.	Just before launching the pop-up window, you can set various display properties on the PrintableDocument object to control the size and placement of the pop-up menu. You can also control what additional elements appear in the pop-up menu. For example, you can turn the toolbar, menu, and scroll bars on or off. Any attributes that are not set are provided by default from the client's browser environment.
Print ()	Use this method to send your report to a print dialog.	While the Show() method may be used to display pure XML in a pop-up window for the user to then manually print, the Print() method throws an exception if there is no XSL document to transform the XML. This occurs because JavaScript can only invoke its print() and close() methods on a window that contains HTML. Attempts to print or close a window with only XML fail, and thus the user is presented with a small, confusing, orphaned window.
SetStyle(&BU_Type, &BU, &Report_Type)	Use this method to set the XSLDocument property based on the Printable Document Framework Repository.	<p>&BU_Type: <i>OM</i> for Order Management or <i>AR</i> for Accounts Receivable.</p> <p>&BU: an <i>OM</i> or "<i>AR</i>" Business Unit</p> <p>&Report_Type: a valid translate value on the SCM_REP_TYPE field</p>

Method	Use	Additional Information
includeXSLTemplate(&templateName as string)	Use this method to include XSL templates stored in HTML objects into an existing XSLDocument.	<p>Several templates are shipped with the product.</p> <p>Include these templates by passing to the includeXSLTemplate() method any PrintableDocument properties having names beginning with "pdXSLTmpl." It is not recommended that you directly pass in the HTML object names of these standard templates, as some require the inclusion of other templates to work properly. Using the pdXSLTmpl properties ensures that any other required templates are included as well.</p>

Properties

This table lists the properties available for use with the Printable Document Object:

Property	Use	Examples, Additional Parameters
rowsetData	Use this property to set the datasource for your report using a rowset.	<p>Example for setting the pop-up window attributes:</p> <pre>&pDoc.Height=400; &pDoc.Width=600; &pDoc.MenuBar=False; &pDoc.StatusBar=True; &pDoc.Resizeable=True;</pre>
XMLDocument	Use this property to set the datasource for a report using a XMLDoc or fetch the XMLDoc result from your rowsetData (convert a rowset to XML)	
XSLDocument	Use this property to set the XSL Stylesheet or to fetch the XSL Stylesheet generated by the SetStyle() method.	
HTMLString	Use this property to set the HTMLString for display or fetch the HTMLString generated from the XMLDocument and XSLDocument.	

Property	Use	Examples, Additional Parameters
printHTML	Use this property if you already have an HTMLArea on the page, and can use it instead of including the delivered sub-page.	
showHTML	Use this property if you already have an HTMLArea on the page, and can use it instead of including the delivered subpage.	
pdXSLTmpltHeader	This is a delivered template for document headers. It puts the company logo in the upper left corner of the page, company address in the upper right, and document title centered and below the other two.	Parameters (any parameters omitted will not appear in the address block): name — Piece of the address block address1 — Piece of the address block address2 — Piece of the address block address3 — Piece of the address block city — Piece of the address block state — Piece of the address block postal — Piece of the address block reportTitle — The title for the report
pdXSLTmpltAddress	This is a delivered template for address blocks.	Parameters (any parameters omitted will not appear in the address block): msgStr — A label for the address block name — Piece of the address block address1 — Piece of the address block address2 — Piece of the address block address3 — Piece of the address block city — Piece of the address block state — Piece of the address block postal — Piece of the address block

Using the Printable Documents Framework

The Style Repository within the Printable Documents Framework provides the ability to define the stylesheet to use with the Printable Documents Framework reports. In addition, this repository allows you to customize the stylesheets and override a given stylesheet for reports at the business-unit level so that a different look-and-feel can be created for reports for each business unit.

Note: The Printable Document Style component will be shipped as system data and should be updated by the developers adding reports to the Printable Document Framework. You will populate the Printable Document Style By Business Unit component if you want to change the default stylesheet by Business Unit for a report within the Printable Document Framework.

The Printable Document Framework supports the following meta-HTML variables within your XSL Stylesheet (Content Name):

- **%REPORT_LOGO** - This meta-variable is replaced with the image entered in the **Report Logo** field at run time.
- **%Bind(:1)** thru **%Bind(:4)** - These meta-variables are replaced with the context entered in the **Sub Content Name** fields at run time.

Pages Used for the Printable Documents Framework

<i>Page Name</i>	<i>Definition Name</i>	<i>Usage</i>
Printable Document Style Page	SAC_RPT_XSLT	Define the default style sheet to be used for printable documents.
Printable Document Style By BU Page	SAC_RPT_XSLT_BU	Define override style sheets to be used when printing documents for a given business unit.

Understanding Business Intelligence Publisher for Picking Plan and Goods Receipts reports

Understanding BI Publisher Picking Plan and Goods Receipts Reports

This section provides an overview of Business Intelligence (BI) Publisher Plan and Goods Receipts reports structure.

Understanding BI Publisher Picking Plan and Goods Receipts Structure

BI Publisher is part of the Oracle technology stack. It enables you to create and customize reports using templates. These templates are maintainable using standard desktop applications such as Microsoft Word, Microsoft Excel, and Adobe Acrobat. It is fairly simple to create and maintain these templates because these applications are familiar tools. The BI Publisher engine takes XML data as input, combines it with the report template, and translates it to produce the report output. The report output can be HTML, PDF, RTF, or XLS. However, the output format is limited to PDF when the output type is Printer.

Note: Order Management generates the Picking Plan and Goods Receipts reports as PDF files.

See the product documentation for *PeopleTools: BI Publisher for PeopleSoft*

Two templates are delivered with PeopleSoft Order Management for printing Picking Plan and Good Receipts using BI Publisher. These templates are RTF templates that were created using Microsoft Word and the BI Publisher Template Builder, which is a plug-in to Microsoft Word.

Setting Up BI Publisher Picking Plan and Goods Receipts Reports

Each template delivered by PeopleSoft Order Management has a data source associated to it. A data source defines how the XML data will be generated. Two data sources are delivered for producing the Picking Plan and Goods receipts respectively: OM_7000_PCK_PLN and OM_7000_GOODS_RECEIPT.

The data source type for Picking Plan is query and the one for Good Receipts is XML file. A XML file will be generated and will serve as the input to the PeopleTools APIs for BI Publisher.

This table shows all of the elements that are delivered in the BI Publisher Goods Receipts and Picking Plan solution

Report Definition	Data Source	Template
OM_GDSRCPT_M	OM_7000_GOODS_RECEIPT	OM_GDSRCPT_MAIN_ENG.rtf
OM_PCK_PLAN	OM_PCK_PLAN	OM_PICK_PLAN_ENG.rtf

The OM_GDSRCPT_M report definition contains two sub-templates. The table below shows the elements for these sub-templates.

Report Definition	Sub-Template Definition	Template
OM_GDSRCPT_M	OM_GDS_RCPT	OM_GDS_RCPT_ENF.rtf
OM_GDSRCPT_M	OM_BACK_ORD	OM_PICK_PLAN_ENG.rtf