PeopleSoft FSCM 9.2: PeopleSoft Engineering

September 2022

PeopleSoft FSCM 9.2: PeopleSoft Engineering
Copyright © 1988, 2022, Oracle and/or its affiliates.

This software and related documentation are provided under a license agreement containing restrictions on use and disclosure and are protected by intellectual property laws. Except as expressly permitted in your license agreement or allowed by law, you may not use, copy, reproduce, translate, broadcast, modify, license, transmit, distribute, exhibit, perform, publish, or display any part, in any form, or by any means. Reverse engineering, disassembly, or decompilation of this software, unless required by law for interoperability, is prohibited.

The information contained herein is subject to change without notice and is not warranted to be error-free. If you find any errors, please report them to us in writing.

If this is software, software documentation, data (as defined in the Federal Acquisition Regulation), or related documentation that is delivered to the U.S. Government or anyone licensing it on behalf of the U.S. Government, then the following notice is applicable:

U.S. GOVERNMENT END USERS: Oracle programs (including any operating system, integrated software, any programs embedded, installed, or activated on delivered hardware, and modifications of such programs) and Oracle computer documentation or other Oracle data delivered to or accessed by U.S. Government end users are "commercial computer software," "commercial computer software documentation," or "limited rights data" pursuant to the applicable Federal Acquisition Regulation and agency-specific supplemental regulations. As such, the use, reproduction, duplication, release, display, disclosure, modification, preparation of derivative works, and/or adaptation of i) Oracle programs (including any operating system, integrated software, any programs embedded, installed, or activated on delivered hardware, and modifications of such programs), ii) Oracle computer documentation and/or iii) other Oracle data, is subject to the rights and limitations specified in the license contained in the applicable contract. The terms governing the U.S. Government's use of Oracle cloud services are defined by the applicable contract for such services. No other rights are granted to the U.S. Government.

This software or hardware is developed for general use in a variety of information management applications. It is not developed or intended for use in any inherently dangerous applications, including applications that may create a risk of personal injury. If you use this software or hardware in dangerous applications, then you shall be responsible to take all appropriate fail-safe, backup, redundancy, and other measures to ensure its safe use. Oracle Corporation and its affiliates disclaim any liability for any damages caused by use of this software or hardware in dangerous applications.

Oracle®, Java, and MySQL are registered trademarks of Oracle and/or its affiliates. Other names may be trademarks of their respective owners.

Intel and Intel Inside are trademarks or registered trademarks of Intel Corporation. All SPARC trademarks are used under license and are trademarks or registered trademarks of SPARC International, Inc. AMD, Epyc, and the AMD logo are trademarks or registered trademarks of Advanced Micro Devices. UNIX is a registered trademark of The Open Group.

This software or hardware and documentation may provide access to or information about content, products, and services from third parties. Oracle Corporation and its affiliates are not responsible for and expressly disclaim all warranties of any kind with respect to third-party content, products, and services unless otherwise set forth in an applicable agreement between you and Oracle. Oracle Corporation and its affiliates will not be responsible for any loss, costs, or damages incurred due to your access to or use of third-party content, products, or services, except as set forth in an applicable agreement between you and Oracle.

Documentation Accessibility

For information about Oracle's commitment to accessibility, visit the Oracle Accessibility Program website at <https://docs.oracle.com/pls/topic/lookup?ctx=acc&id=docacc>.

Access to Oracle Support

Oracle customers that have purchased support have access to electronic support through My Oracle Support. For information, visit <https://docs.oracle.com/pls/topic/lookup?ctx=acc&id=info> or visit <https://docs.oracle.com/pls/topic/lookup?ctx=acc&id=trs> if you are hearing impaired.

Contents

Preface: Preface.....	ix
Understanding the PeopleSoft Online Help and PeopleBooks.....	ix
Hosted PeopleSoft Online Help.....	ix
Locally Installed Help.....	ix
Downloadable PeopleBook PDF Files.....	ix
Common Help Documentation.....	ix
Field and Control Definitions.....	x
Typographical Conventions.....	x
ISO Country and Currency Codes.....	x
Region and Industry Identifiers.....	xi
Translations and Embedded Help.....	xi
Using and Managing the PeopleSoft Online Help.....	xii
PeopleSoft FSCM Related Links.....	xii
Contact Us.....	xii
Follow Us.....	xii
Chapter 1: Getting Started with PeopleSoft Engineering.....	15
PeopleSoft Engineering Integrations.....	15
PeopleSoft Engineering Implementation.....	16
Common Elements Used in PeopleSoft Engineering.....	17
Chapter 2: PeopleSoft Engineering Overview.....	19
Examining the PeopleSoft Engineering Product Strategy.....	19
Reviewing Traditional MRPII Systems.....	19
Increasing Engineering Process Participation.....	19
Responding to Requirements.....	20
Managing Change.....	20
Working with an Independent Engineering Workbench.....	21
Using the Robust ECR and ECO Functionality.....	22
Introducing ECR Features.....	22
Understanding ECO Features.....	22
Managing PeopleSoft Engineering Documents.....	24
Generating and Examining Item Costs Within PeopleSoft Engineering.....	25
Exchanging Data Between PeopleSoft Engineering and PeopleSoft Manufacturing.....	25
Making BOM Mass Changes Using Mass Maintenance.....	25
Importing BOMs from External Sources.....	26
Displaying PeopleSoft Engineering Inquiries.....	26
Communicating BOM and Engineering Changes to Suppliers.....	27
Listing PeopleSoft Engineering Reports.....	27
Putting It All Together.....	27
Chapter 3: Structuring PeopleSoft Engineering.....	29
Setting Up PeopleSoft Engineering Tables.....	29
Setting Engineering Options.....	29
Page Used to Set Engineering Options.....	29
Engineering Options Page.....	29
Configuring Your Document Management System.....	31
Prerequisites.....	32
Defining Engineering Codes.....	32

Pages Used to Define Engineering Codes.....	33
Defining ECO Approval Types.....	33
Page Used to Define ECO Approval Type.....	34
ECO Approval Types Page.....	34
Chapter 4: Maintaining Engineering Bills of Material.....	37
Understanding PeopleSoft Engineering Bills of Material.....	37
Prerequisites.....	37
Common Elements Used in Maintaining Engineering Bills of Material.....	38
Prerequisites.....	39
Defining Items for Use in PeopleSoft Engineering.....	39
Maintaining BOMs by Revisions or Effectivity Dates.....	40
Maintaining Revisions.....	40
Verifying EBOMs Online and Defining Component Revision Settings.....	40
Multiple Output BOM Considerations.....	40
Assigning Associated Primary BOMs.....	42
Defining Engineering Copy and Delete Options.....	42
Using Document Management.....	42
Maintaining Engineering Bills of Material.....	43
Pages Used to Maintain Engineering Bills of Material.....	43
Engineering BOMs - Summary Page.....	45
Engineering BOMs - Header: Assembly Attachments Page.....	51
Engineering BOMs - Header: Outputs Page.....	52
Engineering BOMs - Header: Supplier Access List Page.....	58
Engineering BOMs - Components: Component Details Page.....	59
Engineering BOMs - Components: Attachments Page.....	64
Engineering BOMs - Components: Substitutes Page.....	65
Copying and Transferring EBOMs.....	66
Pages Used to Copy and Transfer EBOMs.....	66
Copying Engineering BOMs Page.....	67
Copy Engineering BOM Detail Page.....	69
Copy Outputs Page.....	72
Transferring EBOMs.....	72
Deleting EBOMs.....	72
Page Used to Delete EBOMs.....	73
Delete EBOMs Page.....	73
Checking the EBOM Verification Status.....	74
Pages Used to Check the EBOM Verification Status.....	74
EBOM Looping Verification Page.....	74
Delete Verification Details Page.....	76
EBOM Verification Status Page.....	77
BOM Verification Detail Page.....	78
Chapter 5: Making Mass Engineering Bill of Material Changes.....	81
Understanding Mass BOM Changes.....	81
Mass BOM Changes.....	81
Example Scenarios for Mass BOM Changes.....	81
Defining Engineering BOM MMCs.....	84
Pages Used to Define BOM MMCs.....	84
Understanding Engineering BOM MMCs.....	86
Prerequisites.....	87
BOM Mass Maintenance Codes - Search Page.....	87
Assembly/Component Matches Page.....	89

Reference Designators - Search Page.....	90
Component Substitutes - Search Page.....	90
BOM Mass Maintenance Codes - Change Page.....	91
Component Dimensions - Change Page.....	94
Reference Designators - Change Page.....	95
Component Substitutes - Change Page.....	95
BOM Mass Maintenance Codes - Add Page.....	97
Component Substitutes - Add Page.....	99
Making BOM Mass Changes and Creating Automatic Revisions.....	99
Pages Used to Make BOM Mass Changes and Create Automatic Revisions.....	100
Understanding BOM Mass Changes and Automatic Revisions.....	100
Common Elements Used in This Section.....	102
Apply Mass Changes by ECO Page.....	103
Mass Maint Code Options Page.....	105
Assembly Item Options Page.....	106
Select Assemblies by Items Where Used Page.....	106
Mass Maintenance Exceptions Page.....	109
Viewing and Correcting BOM Messages Using Staged BOMs.....	110
Pages Used to View and Correct BOM Messages Using Staged BOMs.....	111
Update Staged EBOM Details - BOM Status Page.....	111
Update Staged EBOM Details - Summary Page.....	113
Update Staged EBOM Details - Header: Outputs Page.....	113
Processing Staged EBOMs.....	114
Page Used to Process Staged EBOMs.....	114
Process Staged EBOMs Page.....	114
Chapter 6: Displaying Engineering Bills of Material.....	117
Displaying Engineering BOM Structures.....	117
Pages Used to Display Engineering BOM Structures.....	117
Common Elements Used in This Section.....	117
Review EBOM Information - Summary Page.....	118
Review EBOM Information - Component Substitutes page.....	120
Engineering BOM inquiry - Header: Outputs Page.....	120
Engineering BOM inquiry - Comp Detail: Component Details Page.....	121
Displaying Summarized Engineering BOMs.....	122
Pages Used to Display Summarized Engineering BOMs.....	122
EBOM Summarized Page.....	122
EBOM Summarized Outputs Page.....	124
Displaying Engineering BOM Costs.....	125
Pages Used to Display Engineering BOM Costs.....	125
Understanding Engineering BOM Costs.....	125
Costed EBOMs Page.....	126
Output Costs Page.....	131
Component Detail Costs Page.....	132
Comparing Engineering BOMs.....	133
Pages Used to Compare Engineering BOMs.....	133
Common Element Used in This Section.....	134
Compare EBOMs - BOM Selections Page.....	135
BOM Selections - Component Details Page.....	136
BOM Selections - Component Details: Substitutes Page.....	137
BOM Selections - Assembly Header: Outputs Page.....	137
Viewing Item Where-Used Information.....	138

Pages Used to View Item Where-Used Information.....	138
Item Where Used Page.....	138
Viewing BOM and Routing Transfer and Copy Data.....	140
Chapter 7: Structuring Engineering Routings.....	141
Understanding Engineering Routings.....	141
Prerequisites.....	141
Common Elements Used in This topic.....	142
PeopleSoft Engineering Routings.....	143
Maintaining PeopleSoft Engineering Routings.....	143
Pages Used to Maintain Engineering Routings.....	143
Understanding PeopleSoft Engineering Routing Maintenance.....	144
Common Elements Used in This Section.....	145
Define Engineering Routings - Summary Page.....	145
Define Engineering Routings - Header: Description Page.....	147
Define Engineering Routings - Header: Attachments Page.....	148
Define Engineering Routings - Operations: Resources Page.....	149
Define Engineering Routings - Operations: Scheduling Page.....	151
Define Engineering Routings - Operations: Times Page.....	153
Define Engineering Routings - Operations: Conv Cost Codes Page.....	156
Define Engineering Routings - Operations: Attachments Page.....	157
Defining Master Routings.....	158
Pages Used to Define Master Routings.....	158
Copying and Transferring Engineering Routings.....	158
Pages Used to Copy and Transfer Engineering Routings.....	159
Copy Routing Page.....	159
Copy Routing Detail Page.....	161
Routing Transfer/Copy Audit Page.....	162
Deleting Engineering Routings.....	163
Page Used to Delete Engineering Routings.....	163
Delete Engineering Routings Page.....	163
Comparing Engineering Routings.....	164
Pages Used to Compare Engineering Routings.....	164
Common Elements Used in This Section.....	165
Routing Comparison - Rtg Selections Page.....	165
Routing Comparison - Header: Details Page.....	166
Routing Comparison - Operations: Details Page.....	167
Routing Comparison - Operations: Resources Page.....	168
Routing Comparison - Operations: Times Page.....	169
Chapter 8: Costing Items That Reside Within PeopleSoft Engineering.....	171
Using PeopleSoft Cost Management Functionality to Cost Items Within PeopleSoft Engineering.....	171
Calculating Item Costs for Items Within PeopleSoft Engineering.....	171
Chapter 9: Creating Engineering Change Requests (ECRs).....	173
Understanding PeopleSoft Engineering ECRs.....	173
Prerequisites.....	173
Creating and Maintaining ECRs.....	174
Pages Used to Create and Maintain ECRs.....	174
Common Element Used in This Section.....	175
Maintain ECRs - Header: Header Page.....	175
Maintain ECRs - Header: Reason/Action Page.....	179
Maintain ECRs - Header: Attachments Page.....	180

Chapter 10: Creating Engineering Change Orders (ECOs)	181
Understanding PeopleSoft Engineering ECOs.....	181
Prerequisites.....	181
Creating and Maintaining ECOs.....	182
Pages Used to Create and Maintain ECOs.....	182
Common Elements Used in This Section.....	184
Maintain ECOs - Header: Header Page.....	186
Maintain ECOs - Header: Reason/Action Page.....	192
Maintain ECOs - Header - Attachments Page.....	193
Maintain ECOs - Items Affected: Status Page.....	194
Maintain ECOs - Workflow Page.....	195
Maintain ECOs - Approval Page.....	197
Chapter 11: Processing ECRs and ECOs	199
Understanding ECR and ECO Processing.....	199
Prerequisites.....	200
Approving and Converting ECRs.....	201
Page Used to Approve and Convert ECRs.....	201
Approve/Convert ECRs Page.....	201
Promoting ECO Activities.....	203
Page Used to Promote ECO Activities.....	203
Promote ECO Activity Page.....	203
Approving ECOs.....	204
Page Used to Approve ECOs.....	204
Approve ECO Page.....	204
Viewing Approved, Denied, and Recycled ECO Activities.....	206
Page Used to View Approved, Denied, and Recycled ECO Activities.....	206
ECO Workflow Approval Page.....	206
Transferring BOMs and Routings.....	207
Pages Used to Transfer BOMs and Routings.....	207
Transfer Selection Page.....	208
ECO Selection Page.....	210
Assembly Selection Page.....	214
BOM Exception Page.....	215
Routing Exception Page.....	216
Making Mass BOM Changes by ECO and Automatically Creating New Item Revisions by ECO.....	216
Chapter 12: Managing Documents	217
Understanding Document Management in PeopleSoft Engineering.....	217
Prerequisites.....	217
Examining the Embedded Document Management System.....	218
Document User Types.....	218
Adding New Documents or New Versions of Existing Documents to the Vault.....	219
Associating Documents to Pages and Copying Document Associations.....	219
Managing Documents in PeopleSoft Engineering.....	220
Pages Used to Manage Documents in PeopleSoft Engineering.....	220
Component Options Page.....	220
Signing In to the Documentum Doabase.....	222
Query Page.....	222
Search Results Page.....	223
Copy Document Associations Page.....	224
Disassociating Documents from Pages.....	224

Viewing, Editing, Checking In and Out, and Fixing Documents.....	224
Modifying Page Objects and PeopleCode.....	227
Printing Documents.....	227
Chapter 13: Managing BOMs and Engineering Changes for Suppliers.....	229
Understanding BOMs and Engineering Changes for Suppliers.....	229
Prerequisites.....	229
Capabilities to Share PeopleSoft Engineering Information.....	230
Attachments and Email Capability.....	231
Functionality Reflected in PeopleSoft Manufacturing and PeopleSoft Engineering.....	232
Common Elements Used in Managing BOMs and Engineering Change Orders for Suppliers.....	232
Viewing BOMs.....	233
Pages Used to View Supplier-Related BOMs.....	233
Select Supplier Page.....	233
Select Bill of Material Page.....	234
Filter Options Page.....	234
Bill of Material Page.....	234
Component Detail Page.....	235
Viewing, Adding, or Updating ECRs.....	236
Pages Used to View, Add, or Update Supplier-Related ECRs.....	236
Select Supplier Page.....	236
Select Change Request Page.....	236
Filter Options Page.....	237
Change Request Detail Page.....	238
Engineering Change Request - Item Affected Detail Page.....	239
Viewing ECOs/Workflow.....	239
Pages Used to View Supplier-Related ECOs/Workflow.....	240
Select Supplier Page.....	240
Select Change Order Page.....	241
Change Order Detail Page.....	241
Engineering Change Order - Item Affected Detail Page.....	242
Chapter 14: Delivered Workflows for PeopleSoft Engineering.....	245
Appendix: Delivered Workflows for PeopleSoft Engineering.....	245
Delivered Workflows for PeopleSoft Engineering.....	245
Chapter 15: PeopleSoft Engineering Reports.....	249
Appendix: PeopleSoft Engineering Standard Reports.....	249
PeopleSoft Engineering Standard Reports: General Description.....	249
PeopleSoft Engineering Reports: A to Z.....	251
EGS1000 - ECO Report.....	251
ENS1000 - BOM Report.....	252
ENS1001 - Routing Report.....	253
ENS1002 - Compare Routings Report.....	253
ENS1003 - Master Routing Where Used Report.....	254
ENS1005 - Compare BOMs Report.....	255
ENS1010 - BOM Cost Report.....	257
ENS2000 - Item Where Used Report.....	258

Preface

Understanding the PeopleSoft Online Help and PeopleBooks

The PeopleSoft Online Help is a website that enables you to view all help content for PeopleSoft applications and PeopleTools. The help provides standard navigation and full-text searching, as well as context-sensitive online help for PeopleSoft users.

Hosted PeopleSoft Online Help

You can access the hosted PeopleSoft Online Help on the [Oracle Help Center](#). The hosted PeopleSoft Online Help is updated on a regular schedule, ensuring that you have access to the most current documentation. This reduces the need to view separate documentation posts for application maintenance on My Oracle Support. The hosted PeopleSoft Online Help is available in English only.

To configure the context-sensitive help for your PeopleSoft applications to use the Oracle Help Center, see [Configuring Context-Sensitive Help Using the Hosted Online Help Website](#).

Locally Installed Help

If you're setting up an on-premise PeopleSoft environment, and your organization has firewall restrictions that prevent you from using the hosted PeopleSoft Online Help, you can install the online help locally. See [Configuring Context-Sensitive Help Using a Locally Installed Online Help Website](#).

Downloadable PeopleBook PDF Files

You can access downloadable PDF versions of the help content in the traditional PeopleBook format on the [Oracle Help Center](#). The content in the PeopleBook PDFs is the same as the content in the PeopleSoft Online Help, but it has a different structure and it does not include the interactive navigation features that are available in the online help.

Common Help Documentation

Common help documentation contains information that applies to multiple applications. The two main types of common help are:

- Application Fundamentals
- Using PeopleSoft Applications

Most product families provide a set of application fundamentals help topics that discuss essential information about the setup and design of your system. This information applies to many or all applications in the PeopleSoft product family. Whether you are implementing a single application, some combination of applications within the product family, or the entire product family, you should be familiar with the contents of the appropriate application fundamentals help. They provide the starting points for fundamental implementation tasks.

In addition, the *PeopleTools: Applications User's Guide* introduces you to the various elements of the PeopleSoft Pure Internet Architecture. It also explains how to use the navigational hierarchy, components, and pages to perform basic functions as you navigate through the system. While your application or implementation may differ, the topics in this user's guide provide general information about using PeopleSoft applications.

Field and Control Definitions

PeopleSoft documentation includes definitions for most fields and controls that appear on application pages. These definitions describe how to use a field or control, where populated values come from, the effects of selecting certain values, and so on. If a field or control is not defined, then it either requires no additional explanation or is documented in a common elements section earlier in the documentation. For example, the Date field rarely requires additional explanation and may not be defined in the documentation for some pages.

Typographical Conventions

The following table describes the typographical conventions that are used in the online help.

<i>Typographical Convention</i>	<i>Description</i>
Key+Key	Indicates a key combination action. For example, a plus sign (+) between keys means that you must hold down the first key while you press the second key. For Alt+W , hold down the Alt key while you press the W key.
... (ellipses)	Indicate that the preceding item or series can be repeated any number of times in PeopleCode syntax.
{ } (curly braces)	Indicate a choice between two options in PeopleCode syntax. Options are separated by a pipe ().
[] (square brackets)	Indicate optional items in PeopleCode syntax.
& (ampersand)	When placed before a parameter in PeopleCode syntax, an ampersand indicates that the parameter is an already instantiated object. Ampersands also precede all PeopleCode variables.
⇒	This continuation character has been inserted at the end of a line of code that has been wrapped at the page margin. The code should be viewed or entered as a single, continuous line of code without the continuation character.

ISO Country and Currency Codes

PeopleSoft Online Help topics use International Organization for Standardization (ISO) country and currency codes to identify country-specific information and monetary amounts.

ISO country codes may appear as country identifiers, and ISO currency codes may appear as currency identifiers in your PeopleSoft documentation. Reference to an ISO country code in your documentation does not imply that your application includes every ISO country code. The following example is a country-specific heading: "(FRA) Hiring an Employee."

The PeopleSoft Currency Code table (CURRENCY_CD_TBL) contains sample currency code data. The Currency Code table is based on ISO Standard 4217, "Codes for the representation of currencies," and also relies on ISO country codes in the Country table (COUNTRY_TBL). The navigation to the pages where you maintain currency code and country information depends on which PeopleSoft applications you are using. To access the pages for maintaining the Currency Code and Country tables, consult the online help for your applications for more information.

Region and Industry Identifiers

Information that applies only to a specific region or industry is preceded by a standard identifier in parentheses. This identifier typically appears at the beginning of a section heading, but it may also appear at the beginning of a note or other text.

Example of a region-specific heading: "(Latin America) Setting Up Depreciation"

Region Identifiers

Regions are identified by the region name. The following region identifiers may appear in the PeopleSoft Online Help:

- Asia Pacific
- Europe
- Latin America
- North America

Industry Identifiers

Industries are identified by the industry name or by an abbreviation for that industry. The following industry identifiers may appear in the PeopleSoft Online Help:

- USF (U.S. Federal)
- E&G (Education and Government)

Translations and Embedded Help

PeopleSoft 9.2 software applications include translated embedded help. With the 9.2 release, PeopleSoft aligns with the other Oracle applications by focusing our translation efforts on embedded help. We are not planning to translate our traditional online help and PeopleBooks documentation. Instead we offer very direct translated help at crucial spots within our application through our embedded help widgets. Additionally, we have a one-to-one mapping of application and help translations, meaning that the software and embedded help translation footprint is identical—something we were never able to accomplish in the past.

Using and Managing the PeopleSoft Online Help

Select About This Help in the left navigation panel on any page in the PeopleSoft Online Help to see information on the following topics:

- Using the PeopleSoft Online Help.
- Managing hosted Online Help.
- Managing locally installed PeopleSoft Online Help.

PeopleSoft FSCM Related Links

[Oracle Help Center](#)

[Hosted Online Help](#)

[PeopleSoft Information Portal](#)

[My Oracle Support](#)

Financial and Supply Chain Management information for Search Framework search engine can be found in PeopleSoft Application Fundamentals documentation. For application specific information, see the "Understanding Search Pages within Components " (Application Fundamentals) topic.

[PeopleSoft Training from Oracle University](#)

[PeopleSoft Video Feature Overviews on YouTube](#)

[PeopleSoft Business Process Maps \(Microsoft Visio format\)](#)

[PeopleSoft Spotlight Series](#)

Contact Us

Send your suggestions to pssoft-infodev_us@oracle.com.

Please include the applications update image or PeopleTools release that you're using.

Follow Us

<i>Icon</i>	<i>Link</i>
	<u>YouTube</u>

Icon	Link
	Twitter@PeopleSoft_Info.
	PeopleSoft Blogs
	LinkedIn

Chapter 1

Getting Started with PeopleSoft Engineering

PeopleSoft Engineering Integrations

PeopleSoft Engineering integrates with these PeopleSoft products:

- PeopleSoft Manufacturing
- PeopleSoft Cost Management
- PeopleSoft Inventory

PeopleSoft Manufacturing

You can take advantage of the integration between PeopleSoft Engineering and PeopleSoft Manufacturing to:

- Maintain both engineering bills of material and manufacturing BOMs.
- Maintain both engineering and manufacturing routings.
- Transfer BOMs and Routings between PeopleSoft Engineering and PeopleSoft Manufacturing.
- Maintain document versions associated with component lists and operation lists used in the production process.
- Make mass changes to manufacturing BOMs using ECOs.
- View engineering change orders (ECOs).

PeopleSoft Cost Management

PeopleSoft Cost Management uses PeopleSoft Engineering data to calculate the cost of an item based on an engineering BOM (EBOM) and an engineering routing. Using PeopleSoft Cost Management, you define engineering versions and calculate the effects of engineering changes on existing items. In addition, you can also use an engineering version for cost estimates.

PeopleSoft Inventory

PeopleSoft Engineering accesses items in PeopleSoft Inventory to enable you to specify EBOM components that are still pending (pre-approved) in PeopleSoft Inventory. This enables you to complete item initialization and approval independent of EBOM maintenance.

If a co-product can be manufactured on multiple BOMs, you define within PeopleSoft Inventory an associated primary BOM that determines which BOM is used to explode the item to lower levels.

See also the product documentation for:

- *PeopleSoft Manufacturing*
- *PeopleSoft Cost Management*
- *PeopleSoft Inventory*

PeopleSoft Engineering Implementation

PeopleSoft Setup Manager enables you to generate a list of setup tasks for your organization based on the features that you are implementing. The setup tasks include the components that you must set up, listed in the order in which you must enter data into the component tables, and links to the corresponding product documentation.

PeopleSoft Engineering also provides component interfaces to help you load data from your existing system into PeopleSoft Engineering tables. Use the Excel to Component Interface utility with the component interfaces to populate the tables.

This table lists all of the components that have component interfaces:

Component	Component Interface	Reference
Item Load from Excel	IN_MST_ITM_XLS	See "Understanding Item Loading" (PeopleSoft Managing Items).
Define Item Groups	INV_ITEM_GROUPS.CI	See "Item Groups Page" (PeopleSoft Managing Items).
BOM Access by Supplier	EN_IC_BOM_PRIV_CI	See "Defining BOM, ECR, and ECO Access by Supplier" (PeopleSoft Manufacturing).
Define Engineering Routings	EN_EROUTING_CI	See PeopleSoft Engineering Routings .

Other Sources of Information

In the planning phase of your implementation, take advantage of all PeopleSoft sources of information, including the installation guides, table-loading sequences, data models, and business process maps. A complete list of these resources appears in the preface in the *PeopleSoft Application Fundamentals* with information about where to find the most current version of each.

See also the product documentation for:

- *PeopleSoft Application Fundamentals*
- *PeopleTools: PeopleSoft Setup Manager*
- *PeopleTools: PeopleSoft Component Interfaces*

Common Elements Used in PeopleSoft Engineering

Field or Control	Description
As of Date	The last date for which a report or process includes data.
Description	Freeflow text up to 30 characters.
Effective Date	Date on which a table row becomes effective; the date that an action begins. For example, if you want to close out a ledger on June 30, the effective date for the ledger closing would be July 1. This date also determines when you can view and change the information. Pages and batch processes that use the information use the current row.
EmplID (employee ID)	Unique identification code for an individual associated with your organization.
Language or Language Code	<p>The language in which you want the field labels and report headings of the reports to print. The field values appear as you enter them.</p> <p>Language also refers to the language spoken by an employee, applicant, or non-employee.</p>
Process Frequency	<p>Designates the appropriate frequency in the Process Frequency group box:</p> <ul style="list-style-type: none"> • <i>Once</i> executes the request the next time the batch process runs. After the batch process runs, the process frequency is automatically set to <i>Don't Run</i>. • <i>Always</i> executes the request every time the batch process runs. • <i>Don't Run</i> ignores the request when the batch process runs.
Report ID	The report identifier.
Report Manager	This button takes you to the Report List page, where you can view report content, check the status of a report, and see content detail messages (which show you a description of the report and the distribution list).
Process Monitor	This button takes you to the Process List page, where you can view the status of submitted process requests.

Field or Control	Description
Run	This button takes you to the Process Scheduler request page, where you can specify the location where a process or job runs and the process output format.
Run Control ID	A request identification that represents a set of selection criteria for a report or process.
User ID	The system identifier for the individual who generates a transaction.
SetID	An identification code that represents a set of control table information or tableSets. A tableSet is a group of tables (records) necessary to define your company's structure and processing options.
Short Description	Freeflow text up to 15 characters.
Standard Unit of Measure (UOM)	A type of unit used for quantifying in PeopleSoft systems, and usually associated with items. Depending on the application, units of measure might describe dimensions, weights, volumes, or amounts of locations, containers, or business activities. Examples include inches, pounds, work hours, and standard cost dollars.
Unit (business unit)	An identification code that represents a high-level organization of business information. You can use a business unit to define regional or departmental units within a larger organization.

See the product documentation for: *PeopleTools: PeopleSoft Applications User's Guide* and *PeopleTools: PeopleSoft Process Scheduler*.

Chapter 2

PeopleSoft Engineering Overview

Examining the PeopleSoft Engineering Product Strategy

Customers are now asking ERP software providers: "What can you do to support the engineering requirements of my business?" This is a reasonable question because companies can achieve significant benefits through improved coordination between the engineering and manufacturing sides of their businesses.

Reviewing Traditional MRPII Systems

Traditional MRPII systems focused on a company's manufacturing operations through the production planning, scheduling, tracking, materials management, and accounting functions. Engineering input to that system consisted of bills of material that were often manually re-keyed into the MRP system. What happened in the product design, development, prototyping, and approval stages was invisible to the MRP system and most of its users. These engineering functions were supported by a number of computer systems including CAD systems, project management systems, project costing, and Product Data Management (PDM). When the BOM was finally approved, it was thrown over the wall to manufacturing to be re-keyed into the MRPII system.

Increasing Engineering Process Participation

In traditional systems, many manufacturing system users, who should be participants in the engineering process, aren't able to participate because of the lack of integration between the manufacturing system and the supporting engineering systems. This list demonstrates how different enterprise participants outside the engineering department need to be involved in the process:

- Suppliers need to:
 - Provide component quotes.
 - Participate in the design process.
- Purchasing needs to:
 - Provide and track quotes.
 - Look at the short- and long-term availability of components.
 - Look at short- and long-term contracts and pricing.
- Accounting must evaluate costs, to determine the potential return on investment (ROI) for products.
- Manufacturing needs to determine whether the designs can be manufactured.

- Planners need visibility to future new product requirements so that they can properly plan for new materials and capacity.
- Sales and marketing must review products, for customer feedback.

The engineering system is also involved with product changes that can impact all of the groups mentioned. The ability to effectively coordinate the tasks of all of the participants in the design and approval process and give them timely access to the right information can help businesses to:

- Improve quality.
- Reduce costs.
- Shorten the time to market.

This is where PeopleSoft Engineering and its workflow-enabled system comes in.

Responding to Requirements

In response to these customer requirements, PeopleSoft Engineering provides both specific functionality and openness to other systems. It provides an engineering workbench environment consisting of:

- Engineering bills of material (EBOMs)
- Engineering routings (ERTGs)
- ECRs
- ECOs
- EBOM cost roll-up capability
- Online BOM comparisons
- Seamless integration to a leading document management vault

This functionality, combined with the workflow-enabled PeopleSoft architecture, enables you to manage the routing, approval, and notification of ECRs, ECOs, new BOMs or routings, and existing BOM or routing changes.

Managing Change

We provide all of this because we know that while constant change is a fact of life in today's competitive environment, how you manage that change determines your success. From a product perspective, companies are constantly looking for product improvements to differentiate themselves from their competitors. For that reason, change is good. However, product changes and new product introductions can impact nearly every part of your organization as well as your customers and suppliers. PeopleSoft Engineering is a dynamic product designed to help you manage product introduction and change processes throughout your enterprise by enabling you to manage all types of product data and structures.

You can tailor the PeopleSoft Engineering implementation and complexity to meet your business needs; you can use it to simply maintain new and pending product structures or to manage the engineering change order approval process throughout your organization.

PeopleSoft Engineering delivers:

- An independent engineering *workbench* that isolates changes from production data.
- ECR, ECO functionality, and complete change process support.
- Optionally communicate and share BOM, ECR, and ECO information with suppliers if PeopleSoft Engineering is installed.
- Mass BOM maintenance by ECO or by mass maintenance code.
- Innovative PeopleSoft Navigator and workflow capability.
- Seamless enterprise document management integration.
- Integration with PeopleSoft Cost Management and PeopleSoft Manufacturing (ERP integration).
- The ability to import BOMs from external sources.
- Diverse inquiries.
- Reports.

Working with an Independent Engineering Workbench

PeopleSoft Engineering provides a *workbench* where you can create and maintain engineering data without affecting production. This workbench enables you to:

- Define engineering bills of material (and alternates), routings (and alternates), multiple outputs, and item revisions that incorporate all manufacturing BOM features, including a full range of inquiries, online/background looping verification, prototyping, and multiple configurations.

You can specify both pending and approved items as components on an engineering BOM. In addition, you can specify component placeholders in cases where the item number isn't yet known. When managing engineering BOMs using ECOs, you can view pending ECO information within EBOM and revision pages.

- Transfer manufacturing BOMs and routings into the engineering workbench when you need to modify existing manufacturing BOMs or routings.

Additionally, you can use an existing engineering BOM as the basis for new engineering item BOMs by copying the existing BOM within PeopleSoft Engineering. You can also copy routings from manufacturing or PeopleSoft Engineering. The system maintains a date/time audit trail of BOM and routing movement.

- Compare engineering BOMs.

At any point during the development process, you can compare engineering BOMs online with manufacturing BOMs or other engineering BOMs.

- Perform cost calculations and cost comparisons of changes within engineering BOMs and routings.

This enables you to analyze the impact of engineering change orders (ECOs) on product costs or to estimate the cost of a new manufactured item.

- Receive, review, and maintain engineering change requests (ECRs) that you can, optionally, convert to engineering change orders (ECOs).
- Maintain and route ECOs within workflow so that multiple users can be involved in creating, reviewing, and implementing changes.
- Make mass changes to manufacturing or engineering BOMs, using engineering mass maintenance.
Mass maintenance enables you to change, obsolete, and introduce new components to several BOMs, with a single process.
- Import bills of material from external systems into PeopleSoft Engineering.
- Create a revision scheme and automatically add revisions to assemblies and components as part of the engineering change process.

Using the Robust ECR and ECO Functionality

PeopleSoft Engineering provides complete change process support. While ECRs are an optional feature of PeopleSoft Engineering—you can use ECOs with or without them—they empower individuals in your organization to suggest manufacturing process improvements and to report product defects directly to the engineering department. Change requests can then be reviewed and, when appropriate, approved and converted into ECOs.

Introducing ECR Features

ECR functionality includes:

- Automatic generation of ECR numbers. Multiple numbering prefixes for various ECR classifications.
- Descriptive text, requested priority, department, and requester.
- Details on associated assemblies and revisions requiring change, the type of change required, and association of any supporting documentation with the ECR.
- Relation of the ECR to existing ECOs in the system, as well as to any pertinent documents.
- Unlimited user-defined reason and action codes for the ECR.
- Submission of the ECR to workflow for approval processing.

If the ECR is approved, it can then be converted into an ECO and linked to the original ECR requesting the change.

Understanding ECO Features

An engineering department needs to efficiently manage and document required assembly and component changes. PeopleSoft Engineering answers this need with its engineering change order (ECO) functionality. You can use ECOs to manage the various activities that are required to implement multiple types of engineering changes.

By defining your own ECO types, you can group and classify ECOs that serve different purposes. For example, you might define one ECO type to manage complex bill of material configuration changes and supporting processes. Another you might use to define simple documentation changes that perhaps require a minimal number of steps. We designed engineering ECOs to help you define the scenarios that make sense in your environment.

ECO functionality includes:

- The ability to document the addition of new assembly items and item revisions.
- Coordinating, scheduling, and releasing changes to PeopleSoft Manufacturing.
- Automatic generation of ECO numbers.

Multiple numbering prefixes for various ECO types.

- ECO text, priority, responsible department, and engineer/user.
- Details on assemblies and revisions requiring change, type of change required, and association of any supporting documentation with the ECO at the header and item levels.

Inclusion of reference ECOs.

- Unlimited user-defined reasons and action/impact codes for the ECO that can, for example, describe inventory dispositions.
- (Optional) User-defined ECO approval types.

ECO approval types are predefined by you and are comprised of an optional list of activities that represent the phases or milestones through which the ECO can be promoted. In addition, ECO approval types enable you to define and associate user-defined workflow approval processing for different types of ECOs.

- Submission of the ECO into workflow for user-defined approval processing.

As ECOs pass through various approval points, you can, optionally, promote the ECO activity for a particular ECO. This provides ECO visibility and enables you to determine where it is within its life cycle.

- Making mass EBOM or MBOM changes by specifying single or multiple mass maintenance codes on an ECO.
- Optionally automatic creation of revision numbers for items on the ECO.
- Optionally transferring EBOMs and ERTGs to production using ECOs.

Within an ECO, you can define a list of BOMs and/or routings that can be transferred from manufacturing to engineering, modified with the ECO/Engineering process, and then released (transferred) back to manufacturing in a controlled manner.

Managing PeopleSoft Engineering Documents

PeopleSoft Engineering provides a complete document management solution that gives you, and selected members of your company, access to up-to-date, online information. It keeps a detailed history of changes made to any documentation and limits access to documents, where necessary.

Using an embedded document management system, you can securely vault multiple types of documents, checking documents in and out of the vault while maintaining multiple document versions. You can perform online document queries seamlessly and then view documents directly, launching them from within PeopleSoft applications. Within PeopleSoft Engineering, you can associate pertinent documents to ECRs, ECOs, item revisions, engineering bills of material and routings; within PeopleSoft Manufacturing, you can associate them to manufacturing bills of material; and within PeopleSoft Manufacturing, you can associate them to component and operation lists.

With PeopleSoft Engineering's embedded document control you can:

- Associate vault documents with PeopleSoft data such as ECRs, ECOs, item revisions, and bills of material.

You can define these associations loosely so that as new versions of documents are vaulted, they are automatically associated within PeopleSoft.

- Build intelligence into the document vault so that you can complete engineering-centric lookups.
- Access and launch documents out of the vault directly from within PeopleSoft Engineering.

This feature is provided transparently using PeopleSoft.

- Maintain multiple renditions of a document.

For example, you can vault and maintain documents in native formats and provide a supplier-neutral viewable rendition for the *viewing* audience in PeopleSoft.

- Run online queries against the document vault and retrieve results from within PeopleSoft Engineering.
- Using workflow, route documents online, within engineering, to appropriate personnel for review, markup, and approval.
- Copy document associations online within PeopleSoft.

For example, an ECO might be used to manage several types of documents, such as spreadsheets, CAD, and text; yet only pertinent associated documents are copied to the item revision and made available for the general viewing audience.

Related Links

[Understanding Document Management in PeopleSoft Engineering](#)

Generating and Examining Item Costs Within PeopleSoft Engineering

There is a tight connection between PeopleSoft Engineering and PeopleSoft Cost Management. Within PeopleSoft Cost Management, you can roll up and calculate the cost of new products and determine what effect ECOs will have on an existing product's cost. When you specify existing items as components on the engineering BOM, their costs, along with any pending item costs, are included in the calculation of item costs within PeopleSoft Engineering. By calculating costs in different engineering versions, you can compare the engineering cost version to the production cost version. Additionally, you can compare an engineering cost version to other engineering cost versions. PeopleSoft Engineering also provides a costed engineering BOM that enables you to analyze costs at all levels of the product structure.

PeopleSoft Cost Management integration features include:

- A costed engineering BOM inquiry.
- Engineering cost versions.
- Engineering cost roll-ups.
- Cost versions comparison reporting.

Exchanging Data Between PeopleSoft Engineering and PeopleSoft Manufacturing

PeopleSoft Engineering is tightly integrated with PeopleSoft Manufacturing. You can:

- (Optional) Copy bills of material and routings from PeopleSoft Manufacturing to PeopleSoft Engineering and from PeopleSoft Engineering back to PeopleSoft Manufacturing, without having to use an ECO.

These copies contain *same as except* functionality.

- Transfer new and modified bills of material and routings from PeopleSoft Engineering to PeopleSoft Manufacturing from an approved ECO.

The system maintains an audit trail of what bill and/or routing was transferred at what date and time. With this feature, you can be certain that only approved items and valid BOMs and routings will be released into production.

- You can also transfer BOMs and routings from PeopleSoft Engineering to PeopleSoft Manufacturing or from PeopleSoft Manufacturing to PeopleSoft Engineering, by item list or range.

Making BOM Mass Changes Using Mass Maintenance

PeopleSoft Engineering enables you to make mass engineering or manufacturing BOM changes, using the mass maintenance feature. This enables you to:

- Create mass maintenance codes that enable you to add, change, and obsolete component items on several bills of material in a single process.
- Execute changes in a *Verify only* or *Verify and apply change* mode.
- Optionally 'stage' BOM changes so that changes can be reviewed and modified online prior to moving mass changes to MBOMs or EBOMs.
- Apply changes to BOMs, with or without the use of ECOs.
- Apply changes to engineering BOMs or manufacturing BOMs.
- Make changes to manufacturing BOMs by transferring them to the engineering workbench and then transferring them back or by making these changes directly to the manufacturing BOMs, if wanted.
- Optionally automatically create revisions for BOMs included within an engineering change (without ECOs).

Importing BOMs from External Sources

With the PeopleSoft Bill of Material EIP and Item Master EIP, you can:

- Import new and changed items and item revisions into the PeopleSoft system.
- Import new and changed bills of materials into PeopleSoft Engineering or PeopleSoft Manufacturing.
- Validate and correct errors on imported bills of materials in a separate BOM staging pages.

See also the documentation for *PeopleSoft Engineering*, “Delivered Workflows for PeopleSoft Engineering”.

Related Links

[PeopleSoft Engineering Integrations](#)

Displaying PeopleSoft Engineering Inquiries

A diverse set of inquiries is available with PeopleSoft Engineering including:

- Single-level engineering BOM.
- Multilevel indented engineering BOM.
- Summarized engineering BOM.
- Costed engineering bill of material inquiry.
- Item where-used inquiry.
- Compare engineering BOMs and routings.
- Engineering Master Routing where-used.

- BOM mass maintenance exceptions.
- BOM and routing transfer/copy audit.

Communicating BOM and Engineering Changes to Suppliers

You can use PeopleSoft Engineering to enable suppliers to receive BOM and engineering changes.

See [Understanding BOMs and Engineering Changes for Suppliers](#).

Listing PeopleSoft Engineering Reports

These reports are available:

- Engineering BOM Report.
- Engineering BOM Compare Report.
- Engineering BOM Costed Report.
- Item Where Used Report.
- Engineering Routing Report.
- Engineering Routing Compare Report.
- Engineering Master Routing Where Used Report.
- ECO Report.

Putting It All Together

PeopleSoft Engineering consists of many interrelated parts. The following diagram provides a simplified example of how the various parts (including ECRs, ECOs, item revisions, EBOMs, ERTGs, and associated documents) can be connected. When combined with processes such as creating and viewing engineering change requests and engineering change orders, viewing BOMs, documents and attachments, you can include supplier participation as well.

Engineering change processing with document control

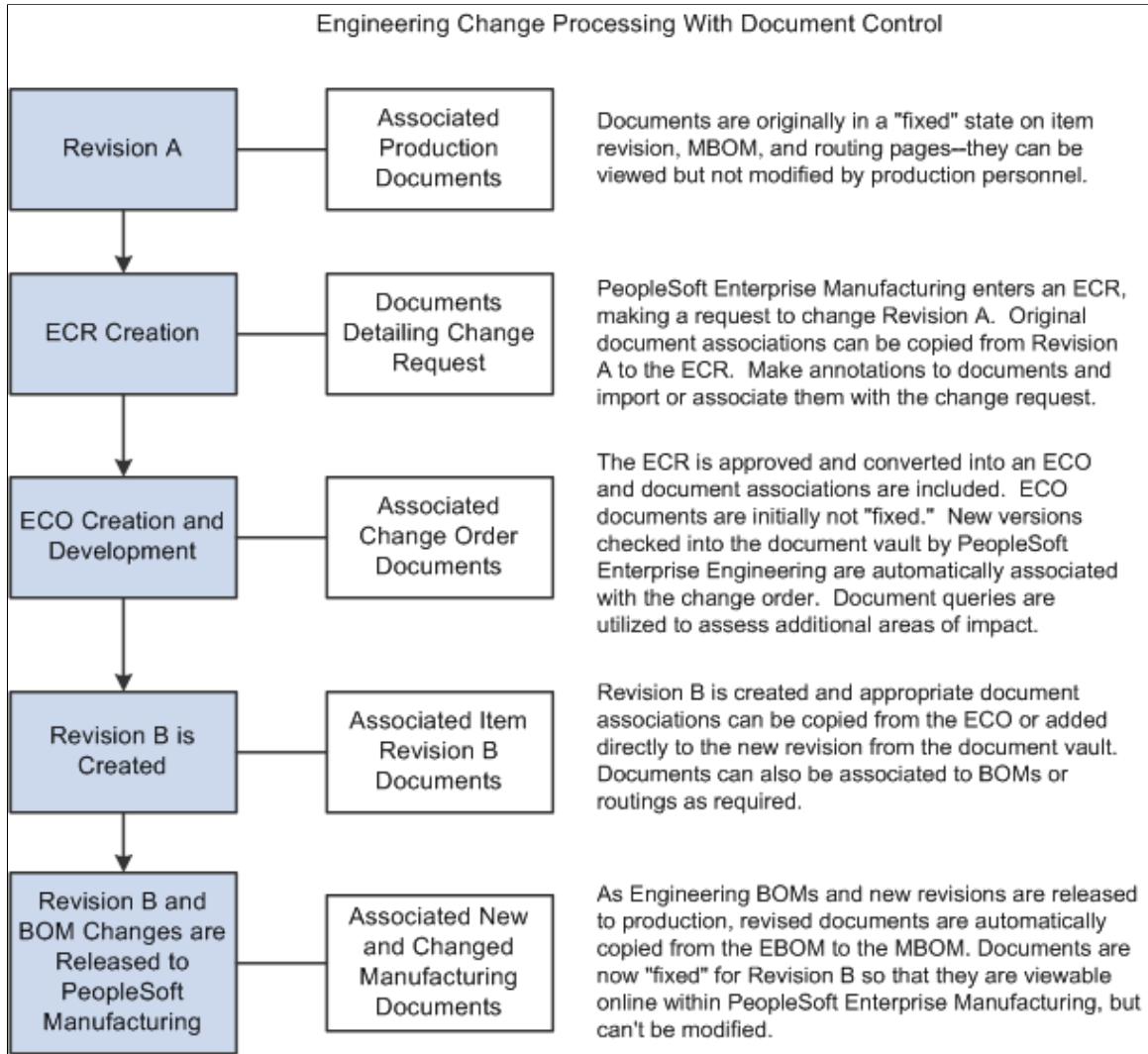

Related Links

[Understanding BOMs and Engineering Changes for Suppliers](#)

Chapter 3

Structuring PeopleSoft Engineering

Setting Up PeopleSoft Engineering Tables

Because of PeopleSoft Engineering's relational design, the order in which you make decisions about how you'll use PeopleSoft Engineering is not necessarily the order in which you enter information into the system. Although certain pages can be considered as a group when making important processing or implementation decisions, you must work with some pages before others when you set up your system for the first time.

These topics outline, from an engineering perspective, the steps that you need to take to:

- Define engineering-related system and business unit defaults.
- Define engineering data.

See [PeopleSoft Engineering Integrations](#).

See "Your Enterprise Data Flow" (PeopleSoft Manufacturing).

Setting Engineering Options

To set up PeopleSoft Engineering business unit-related options, use the Engineering Options (ENG_OPTIONS) component.

Use engineering options to control the ability to copy engineering BOMs (EBOMs) and engineering routings (ERTGs) to manufacturing. You can also indicate whether you want to automatically delete EBOMs and ERTGs once you transfer them to manufacturing. You can also enable workflow for engineering change requests (ECRs) and ECOS.

This topic discusses how to set engineering options.

Page Used to Set Engineering Options

<i>Page Name</i>	<i>Definition Name</i>	<i>Usage</i>
Engineering Options Page	BUS_UNIT_OPT_EG	Define engineering options.

Engineering Options Page

Use the Engineering Options page (BUS_UNIT_OPT_EG) to define engineering options.

Navigation:

Set Up Financials/Supply Chain > Business Unit Related > Engineering > Engineering Options > Engineering Options

<i>Field or Control</i>	<i>Description</i>
Allow EBOM copies to MBOM	<p>As an alternative to using engineering transfers to move BOMs and routings between PeopleSoft Engineering and PeopleSoft Manufacturing, you can additionally copy engineering BOMs and routings to manufacturing using the BOM and routing copy processes. By selecting this check box, you can make copies of EBOMs to MBOMs using selective or <i>same as except</i> functionality. When copying in this manner, the MBOM is completely replaced by the EBOM.</p> <p>If you deselect this check box, you're ensuring that all BOMs transferred from PeopleSoft Engineering are completed by using engineering transfers only.</p>
Allow ERTG copies to MRTG	<p>Select this check box to allow users to copy engineering routing into PeopleSoft Manufacturing using selective or <i>same as except</i> functionality. When copying in this manner, the manufacturing routing is completely replaced by the engineering routing.</p> <p>If you deselect this check box, you're ensuring that all routings transferred from PeopleSoft Engineering are completed by using engineering transfers only.</p>
Delete EBOMs upon Transfer	<p>Select this check box to have the system delete EBOMs from the engineering database as they are transferred to PeopleSoft Manufacturing, using the Engineering Transfer pages. This option applies only when you are transferring EBOMs to PeopleSoft Manufacturing.</p>
Delete ERTGs upon Transfer	<p>Select this check box to have the system delete ERTGs from the engineering database as they are transferred to PeopleSoft Manufacturing, using the Engineering Transfer pages. This option applies only when you are transferring ERTGs to PeopleSoft Manufacturing.</p>
Engineering Workflow Options	<p>Use these options to control whether you use workflow in your ECR or ECO approval processing. Options are:</p> <ul style="list-style-type: none"> • Use ECR Workflow: Select if you want a workflow notification sent when an ECR is saved. • Use ECO Workflow: Select in order to access the Submit (workflow) button on the ECO Workflow page in the ECO Maintenance component.

Note: All PeopleSoft applications include example business processes, but don't include Approval Rule Sets. Therefore, you must create Approval Rule Sets for both ECRs and ECOs before you define the workflow options on this page.

If you want workflow to manage your ECRs, the workflow business process name must be set to ENGINEERING_ECR_NOTIFY. In addition, you'll need to define your workflow approval rule set as ECR Approval.

Note: The naming convention that you use here is extremely important because workflow PeopleCode depends on it.

To set up workflow for ECOs, you must define the business process name and the approval rule set using the ECO Approval Types page. You must associate ECO Approval Types and Business Process Names, using that page, before you select the Use ECO Workflow check box.

When using ECO workflow and an approval type associated to workflow approval rule set is established, then once the ECO is submitted for workflow processing, a workflow approval list (sequential list of roles and role users) is generated and stored with the ECO. At that time, appropriate notifications based on the target role name are generated, using email, worklist, or both; based on this list, by step order. If all approvers are set up in the approval rule set with step 1, then all approvers will be notified at the same time. Otherwise, the approvers at step 1 are notified first. When all approvers in step 1 have approved the ECO, then all approvers in step 2 are notified.

You approve ECOs in PeopleSoft Engineering by using the ECO Maintenance - Approval page. Each approving role user must have access to this page in order to approve the ECO workflow step.

Approvers have two ways to process an ECO workflow and mark a worklist item as worked. Either approvers can manually mark the worklist item as worked or they can go to the ECO Maintenance - Approval page. They can access this page either using a URL from an email notification or by using the navigation system. Once the supplier approves the ECO, the item will be marked as worked if it is a worklist item. This way, the ECO will be deleted from the worklist.

See also the product documentation for *PeopleTools: Workflow Technology*.

Related Links

[Defining ECO Approval Types](#)

Configuring Your Document Management System

The Documentum server (document database) must first be installed and accessible from the PeopleSoft NT server (UNIX is not supported). When accessing Documentum functions through a PeopleSoft Documentum-enabled internet page, the application server accessed using the PeopleSoft page must contain the appropriate Documentum runtime libraries and access to the Documentum server.

Important! The Documentum integration between PeopleSoft and Documentum may require customization as it is no longer a supported integration.

Note: If you have any questions regarding the compatibility of your Documentum system with PeopleSoft Engineering, please contact your account manager.

Prior to using PeopleSoft Engineering with Documentum:

1. Verify that Documentum is installed and that specific Documentum library files (DLLs) are installed on the application servers.

2. Define Documentum options by using the **Set Up Financials/Supply Chain > Common Definitions** navigation.

Prerequisites

Before you use PeopleSoft Documentum integration for the first time, make sure that:

- The Documentum Enterprise Document Management System (EDMS) is installed and accessible by way of Documentum client applications (namely, RightSite).
- These DLL files exist in your PSTools/Bin/Server/Winx86 directory on your application server(s), which need to support Documentum.
 - DMCL40.DLL (Documentum API Library)
 - DMCLVB40.DLL (Documentum Visual Basic API)
- The Documentum initialization file (DMCL.INI) is present in the WINNT directory (Windows NT environment) on your application servers, which need to support Documentum.

Note: The Documentation files (DMCL40.DLL, DMCLVB40.DLL, and DMCL.INI) are delivered with the Documentum application. You can access and copy these files to the appropriate directories after installing Documentum client products such as Workspace and SmartSpace.

- You have defined the URL paths for launching Documentum and viewing documents.

Select **PeopleTools > Utilities > URLs** to update these URL identifiers:

- DOCUMENTUM_LAUNCH: This one should be the http:// address used to launch Documentum's web interface.

Example: http://machinename/rs-bin/RightSite.dll/SSI4 (SSI4 is the executable name for SmartSpace).

- DOCUMENTUM_VIEW: This one should be the partial http:// address used to view documents.

It's similar to the launch path, but without the SSI4 executable at the end. Example: http://machinename/rs-bin/RightSite.dll.

Defining Engineering Codes

To define action codes, use the Action Codes (EG_ACTION_CD) component. To define activity codes for ECOs, use the ECO Activity Codes (EG_ACTIVITY) component. To define classification codes, use the Classification Codes (EG_CLASSIFICATION) component. To define approval type codes for ECOs, use the Approval Type (EG_ECO_APPR_ACTY) component. To define priority codes, use the Priority Codes (EG_PRIORITY) component.

There are several types of engineering codes that you can optionally define prior to using PeopleSoft Engineering. They include reason, priority, classification, action, and engineering activity codes. You can also set up automatic numbering for ECOs and ECRs.

You define reason codes and set up automatic numbering for ECOs and ECRs using pages in the **Set Up Financials/Supply Chain > Common Definitions > Codes and Auto Numbering** navigation.

Pages Used to Define Engineering Codes

<i>Page Name</i>	<i>Definition Name</i>	<i>Usage</i>
Classification Codes	EG_CLASSIFICATION	(Optional) Define classification codes. By associating these codes with ECOs later, you can use these classification codes to denote type of change.
Priority Codes	EG_PRIORITY_CD	(Optional) Denote an ECR's or ECO's priority from the perspective of a requestor or ECO analyst. The system can use this code within the ECR and ECO maintenance pages.
Action Codes	EG_ACTION_CD	(Optional) Define action codes denoting the impact a specific ECR or ECO change will have on areas such as existing production and inventory.
ECO Activity Codes	EG_ACTY_CD	(Optional) Define generic ECO activity codes that can represent phases or milestones pertinent to your engineering change process. Once you have defined these activities, you can link them sequentially with the ECO Approval Types page, to form ECO approval types that you can later associate with ECOs.

Related Links

"Setting Up Financials Audit Framework (Audit Logging)" (Application Fundamentals)

Defining ECO Approval Types

ECO approval types enable you to define a sequence of ECO activities that are defined with the ECO Activity Codes page. You can then associate this sequence of activities with an ECO to denote the appropriate ECO phases, or milestones through which the ECO must be promoted prior to final ECO approval. In addition, ECO approval types enable ECO workflow approval processing when you specify Business Process Name and Approval Rule Set.

This topic discusses how to define ECO approval types.

Page Used to Define ECO Approval Type

Page Name	Definition Name	Usage
<u>ECO Approval Types Page</u>	EG_WF_RTG_TYPE	Define a sequence of ECO activities that are defined with the ECO Activity Codes page.

ECO Approval Types Page

Use the ECO Approval Types page (EG_WF_RTG_TYPE) to define a sequence of ECO activities that are defined with the ECO Activity Codes page.

Navigation:

Set Up Financials/Supply Chain > Product Related > Engineering > ECO Approval Types > ECO Approval Types

This example illustrates the fields and controls on the ECO Approval Types page. You can find definitions for the fields and controls later on this page.

The screenshot displays the 'ECO Approval Types' page. At the top, it shows 'SetID SHARE' and 'ECO Type 100'. The main section is titled 'ECO Approval Types Details' and includes several input fields: '*Effective Date' (12/03/1997), '*Status' (Active), '*Description' (Standard ECO Workflow), 'Business Process Name' (ENGINEERING_ECO_APPROVAL), and 'Approval Rule Set' (WF-1). Below this is a table titled 'ECO Activities' with columns for '*Sequence', '*ECO Activity', and 'Description'. The table contains one row with the sequence number '10'.

To use workflow approval processing for ECOs associated with this ECO approval type, you need to specify an ECO type business process name and Approval Rule Set.

By later associating an ECO type with an ECO, you can both track the sequential list of activities through which the ECO must be promoted (order of promotion) and set an ECO's current activity. When an ECO approval type is defined containing ECO activities, all activities must be promoted prior to final ECO approval.

Field or Control	Description
Approval Rule Set	Defines the sequence of users to include for the ECO workflow. The sequence of users is established and visible on the ECO once the ECO is submitted for workflow.

Field or Control	Description
Sequence and ECO Activity	<p>Optionally select the sequence of ECO activities that make up the ECO type. ECO activities enable you to define user-defined statuses through which the ECO will progress, in addition to the standard ECO statuses of <i>Pending</i>, <i>Approved</i>, and <i>Released</i>. For example, you can have one ECO routing for an item configuration change and another sequence for the change process needed to modify production documents.</p> <p>You can enter an unlimited number of ECO activities.</p>

Note: The presence of ECO activities has no bearing on workflow approval routes, and can be used with or without workflow.

Using workflow with ECO approval types is independent of the number of ECO activities through which the ECO must be promoted. For example, you can define an ECO type associated to an approval rule set that requires several user approvals but has only a single activity to be promoted.

See also the product documentation for *PeopleTools: Workflow Technology*.

Chapter 4

Maintaining Engineering Bills of Material

Understanding PeopleSoft Engineering Bills of Material

Bills of material (BOMs) are structural designs that form the basis of all your item and product structures. To complete important tasks, such as material planning, allocating materials to production, or cost roll-ups, you need accurate and reliable BOMs. Also, as you modify existing products and introduce new products, you need the ability to isolate BOM changes from your production environment. With PeopleSoft Engineering, you can manage and develop EBOMs without affecting your manufacturing BOMs (MBOMs).

In the engineering environment, you can design product structures before you determine and assign all the item attributes. PeopleSoft Engineering enables you to use pending items (preapproved) defined within PeopleSoft Inventory, so that you can complete item initialization and approval independent of EBOM maintenance.

EBOMs differ from MBOMs in that:

- EBOMs are isolated from manufacturing and aren't visible within PeopleSoft Supply Planning or PeopleSoft Manufacturing.
- EBOMs have *relaxed* edit checks.

For example, you can use component *placeholders* on EBOMs when you don't know the actual item number.

- You can add EBOMs for assemblies (and components) that are added in PeopleSoft Inventory, in a pending state.

If you have enabled PeopleSoft Workflow, when a change is made to MBOM or an EBOM, the system uses the BOM Change workflow to send a notification to the manufacturing engineer (or other role) that a BOM has been changed.

See also the product documentation for *PeopleSoft Engineering*, “Delivered Workflows for PeopleSoft Engineering”.

Prerequisites



Before you begin defining and maintaining EBOMs, these steps might be required:

- Define assembly items with business unit attributes in PeopleSoft Inventory; you don't need to approve them, however.
- Decide how to maintain BOMs for assembly items: by effectivity date or by revision.
- Maintain revisions for revision controlled assembly items.

- Decide whether to verify EBOMs online and define component revision settings.
- Determine multiple output BOM considerations.
- (Optional) Assign associated primary BOMs as part of defining multiple outputs.
- Decide whether to allow EBOMs to be copied to PeopleSoft Manufacturing and whether you want to delete EBOMs when they're transferred back to PeopleSoft Manufacturing.
- Determine whether to use the embedded document management system to access revision, assembly, and component documents.

Common Elements Used in Maintaining Engineering Bills of Material

<i>Field or Control</i>	<i>Description</i>
BOM State	Select a BOM state. Values are: <ul style="list-style-type: none"> • <i>Engineering</i>: Select to view EBOMs. • <i>Manufacturing</i>: Select to view MBOMs.
Verify BOM	Indicates whether the system performs online loop checking. Set this option at the manufacturing business unit level with the MFG Business Unit Options page. <p>On the MFG Business Unit Options page, you can elect to always verify online or never verify online. The check box on the Engineering BOM Summary page reflects the manufacturing option that you select.</p> <p>If you select to always verify online, the system checks for looping BOMs as you maintain the assembly or end item's bill. This prevents you from adding the end item as one of its components at this level or any lower levels. If you select to never verify online, loop checking runs as a deferred process.</p>
BOM Type	Select the type of BOM that you are creating. Values are: <ul style="list-style-type: none"> • <i>Production</i>: Uses MBOMs as the basis for manufacturing assemblies or end items. • <i>Rework</i>: Enables you to optionally create rework BOMs when you have a standard rework process where you include additional components. <p>For example, if you have a repair kit of components that you always issue when an item is reworked, you can define that repair kit here. As with MBOMs, you can define a primary rework BOM and up to 98 alternates by creating BOM codes. Rework BOMs aren't required to create rework production IDs.</p>

Field or Control	Description
Per	Select whether the quantity is per assembly (<i>Asy</i>) or per order (<i>Ord</i>).
	If there are any outstanding engineering change orders (ECOs) pending for the item, and you have selected the ECO Pending Alert check box on the ECO Item Status page, the system displays this button next to the assembly item ID. Click this button to view information about the pending ECOs associated with this item.
	Click the Item Search button to access the Item Search Criteria page to locate a different item.

Prerequisites

This topic discusses how to set up prerequisite tasks.

Defining Items for Use in PeopleSoft Engineering

With PeopleSoft Inventory, there is a single point of entry for all items that you use within PeopleSoft Manufacturing. Unlike your production environment, where an item must be approved before it can be accessed within the system, PeopleSoft Engineering can make use of inventory items defined in a pending or approved state, as long as item business unit attributes are defined. For example, when associating an item with a BOM, you can (within PeopleSoft Engineering) immediately access pending items on ECOs and EBOMs.

In addition to using items in a pending state, PeopleSoft Engineering enables you to use placeholder items within BOM maintenance prior to formal component item definition. Placeholder items enable you to define EBOM structure and component information before you enter component item information into the system.

To use pending items or cost component items within PeopleSoft Engineering, you must first define business unit attributes for the items.

The system won't transfer an item from engineering to manufacturing unless the item status is *Active*.

Note: The content in this section is only part of what you need to know to define business unit attributes for items. Other relevant information, because it's common to many applications, is located in the *PeopleSoft Application Fundamentals*. Product documentation

Related Links

[Engineering BOMs - Summary Page](#)

Maintaining BOMs by Revisions or Effectivity Dates

You can maintain item BOMs by:

- Revisions
- Effectivity dates

When you define your assembly items, use the **BOM Usage** group box to determine whether you manage your BOMs by using revisions.

You can indicate that you automatically generate revisions for the item. While you can define at the business unit level that all items in your business unit use automatic revisions by default, you can at the item level change that setting for specific items. Prior to using automatic revisions, you must set up a revision scheme with the Manufacturing Options component.

Related Links

"Maintaining BOMs by Revisions or Effectivity Dates" (PeopleSoft Manufacturing)

Maintaining Revisions

You can maintain revisions, including associated text, documents, and attachments. The item revisions that you create apply to EBOMs and MBOMs.

Related Links

"Defining and Maintaining Revisions" (PeopleSoft Manufacturing)

Verifying EBOMs Online and Defining Component Revision Settings

You can choose how to handle EBOM Online Verification and define component revision default settings on the MFG Business Unit Options page.

Note: When EBOMs are complex and deep, you should select **Never Verify Online** to improve EBOM maintenance performance, and then run the EBOM verification process from the EBOM Looping Verification page.

Related Links

"MFG BU Prdn Options Page" (PeopleSoft Manufacturing)

[EBOM Looping Verification Page](#)

Multiple Output BOM Considerations

There are some conceptual differences between *single-output BOMs* (one primary item) and *multiple output BOMs* (at least one co-product is defined). When you create a *multiple* output BOM with a primary and at least one co-product, consider these points regarding single-output and multiple output BOMs.

Single-Output BOMs

BOM quantity is a scaling device field that enables you to enter a product structure when the assembly specifications are in a base greater than one unit. With BOM quantity, you determine the assembly quantity to which the component's quantity per assembly (QPA) or per order is applied:

- If the BOM quantity is greater than 1, enter the component quantity in terms of the BOM quantity.
- If the BOM quantity is set to 1, the component quantity is the amount of the component required to make one unit.

Use BOM quantity for batched bills or when you know that you will only make a certain quantity of an item at a time.

Multiple Output BOMs

When you define multiple outputs (co-products) for a BOM, you are indicating that:

- At least two end-items are coming out of production, one of which is the primary item.
- The item ID that is specified for the BOM represents a batch item, in addition to representing the primary item to be completed.

The following diagram illustrates a BOM structure that is defined for item ID 6000, or, in other words, item ID 6000 is a batch item. The output for batch item 6000 includes primary item 6000, as well as co-product 6001, recycle by-product 6007, and waste by-product 6009:

BOM with multiple outputs

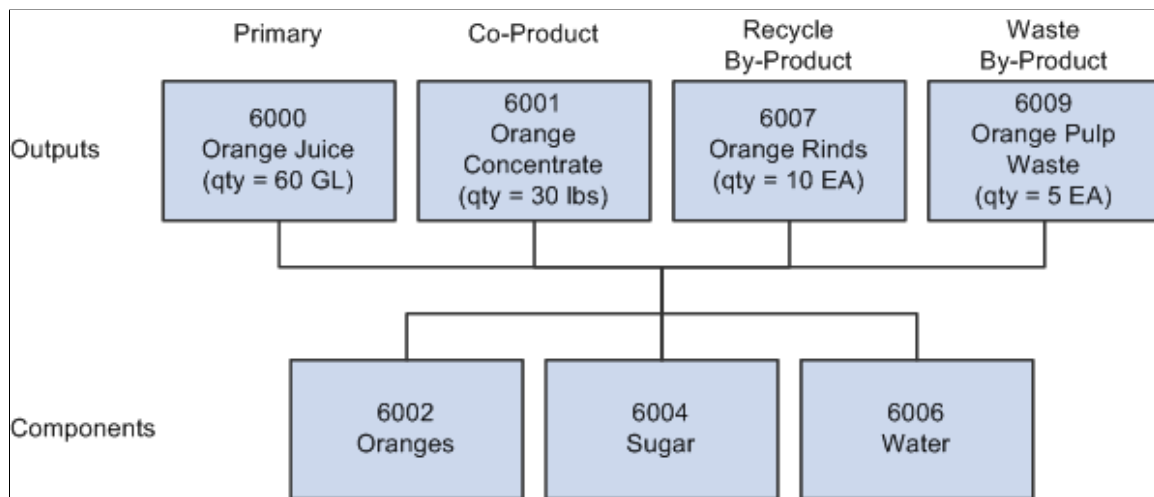

When used on a multiple output BOM, BOM quantity represents the in-process quantity for the BOM item ID as a batch item (as opposed to the item ID as a primary item).

For example, when the BOM structure has a BOM quantity defined as 150, the in-process units of the batch are 150. This also indicates that routing times (planning and costing), as well as rates, are in terms of a single batch unit.

Also, when creating production (IDs or schedules), you must also define the production quantity in terms of batch units. For example a production ID is added for 150 of the batch item 6000 to produce 60 gallons of 6000 and 30 pounds of 6001.

Multiple Output BOMs: Using Yield by Operation

The following diagram illustrates the effect of *yield by operation* on a BOM. This example shows the impact of a 50 percent yield for one operation.

Note: When using yield by operation, the ending quantities for the by-products (recycle or waste) are based on the *operation* start quantity, not the BOM (batch) quantity.

BOM with multiple outputs using yield by operation

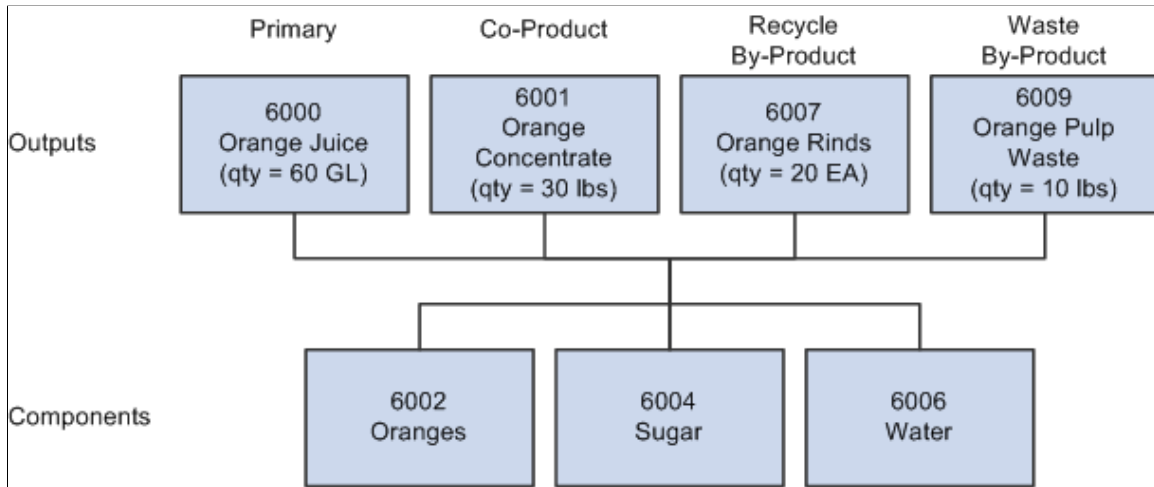

Assigning Associated Primary BOMs

Assign associated primary BOMs if you plan to define BOM co-products.

See "Prerequisites" (PeopleSoft Manufacturing).

Defining Engineering Copy and Delete Options

Copy and delete options control copying engineering BOMs (EBOMs) and engineering routings (ERTGs) to manufacturing.

See [Setting Engineering Options](#).

Using Document Management

If you plan to use the Documentum embedded document management system to access revision, assembly, and component documents, use the Component Options page to define which function buttons are available on the EBOM document management pages.

Related Links

[Managing PeopleSoft Engineering Documents](#)

Maintaining Engineering Bills of Material

To define engineering BOMs, use the Engineering BOM Maintenance (EBOM_MAINTENANCE) component.

With the Engineering BOMs maintenance pages, you can create and maintain the product structure for the engineering version of a manufactured item at a summary or detailed level.

Note: You can view, but not modify or add, MBOMs from these pages. Make changes to MBOMs by transferring or copying EBOMs to MBOMs or by maintaining MBOMs directly within PeopleSoft Manufacturing.

In addition to creating a primary EBOM (with a BOM code equal to 1), you can specify up to 98 alternate EBOMs, by entering additional BOM codes (greater than 1) in the page displayed prior to accessing the Define Engineering Routings pages.

When you need to do additional or repair work on a completed assembly, you can create rework BOMs. This is useful if you have a standard rework process that requires additional components. As with MBOMs, you can define a primary rework BOM and up to 98 alternates, using BOM codes.

Create rework BOMs by selecting *Rework* as the production type when you add a BOM on the BOM Maintenance pages. Rework BOMs are always single-level BOMs. Also, PeopleSoft Cost Management doesn't consider rework BOMs for any type of cost maintenance.

The rework BOM doesn't include the assembly being reworked as a component. In PeopleSoft Manufacturing, when you firm up or release the rework production ID, the system copies the rework BOM to create a component list, and then adds the assembly being reworked. Rework BOMs can't include multiple outputs; the system automatically includes the assembly being reworked as an output when production is created.

Pages Used to Maintain Engineering Bills of Material

Page Name	Definition Name	Usage
Engineering BOMs - Summary Page	EG_BOM_MAINT	Maintain all components that comprise a production EBOM for an assembly in a business unit. Additionally, you can create and maintain a rework BOM to define a standard kit of components for use in repair. You can also indicate which components can be recovered if the assembly is torn down into component parts. Maintain BOMs a single level at a time.
Pending ECOs Page	EG_ECO_DISP_SP	View information about pending ECOs that are associated with the BOM's assembly item. Engineering BOMs - Summary Page

Page Name	Definition Name	Usage
Engineering BOMs - Header: Assembly Text	EG_BOM_TEXT	Associate text with any assembly. This is useful for EBOMs without revision control because text explanations can, in part, make up for the lack of engineering change notices, attached new drawings, and design documents.
<u>Engineering BOMs - Header: Assembly Attachments Page</u>	EG_BOM_ATT	Associate attachments with your EBOMs.
Engineering BOMs - Header: Assembly Documents	EG_BOM_DC	Associate, access, and manage engineering assembly BOM documents in the embedded document management system.
<u>Engineering BOMs - Header: Outputs Page</u>	EG_BOM_OUTPUTS	Define EBOM outputs.
<u>Engineering BOMs - Header: Supplier Access List Page</u>	EG_SS_BOMVND_LST	Access the current list of suppliers who have access to a specific item.
<u>Engineering BOMs - Components: Component Details Page</u>	EG_COMP_MAINT	Add EBOM component details, attach component text, and manage component documents. You can also add reference designators, component dimensions, and substitute components.
Engineering BOMs - Components: Text	EG_COMP_TEXT	Attach and maintain component text. This is useful for BOM types without revision control because text explanations can, in part, make up for the lack of engineering change notices, attached new drawings, and design documents.
<u>Engineering BOMs - Components: Attachments Page</u>	EG_COMP_ATT	Associate attachments with your components.
Engineering BOMs - Components: Documents	EG_COMP_DC	Associate, access, and manage component documents in the embedded document management system.

Page Name	Definition Name	Usage
Engineering BOMs - Components: Reference Designators	EG_COMP_DESIG	Associate reference designators with a component of an assembly item that has an EBOM attached to it. The designator is any alphanumeric code that you use to determine where a component is placed in an assembly. The electronic industry often uses reference designators for positioning of components on circuit boards.
Engineering BOMs - Components: Dimensions	EG_COMP_DIM	Specify and maintain EBOM component dimensions.
<u>Engineering BOMs - Components: Substitutes Page</u>	EG_COMP_SUB	Add substitute components.
Copy Business Unit Substitute Items Page	EN_BOM_SUB_ITEM_SP	View and copy valid substitutes for the component. Changes to the BOM maintenance substitute list in PeopleSoft Advanced Planning Client do not transfer back to the transaction system. <u>Engineering BOMs - Components: Substitutes Page</u>

Related Links

[Displaying Engineering BOM Structures](#)

Engineering BOMs - Summary Page

Use the Engineering BOMs - Summary page (EG_BOM_MAINT) to maintain all components that comprise a production EBOM for an assembly in a business unit.

Additionally, you can create and maintain a rework BOM to define a standard kit of components for use in repair. You can also indicate which components can be recovered if the assembly is torn down into component parts. Maintain BOMs a single level at a time.

Navigation:

Engineering > BOMs and Revisions > Maintain EBOMs and Revisions > Engineering BOMs > Summary

This example illustrates the fields and controls on the Engineering BOMs - Summary page. You can find definitions for the fields and controls later on this page.

Summary Header Components																																																								
Unit US008	BOM State Engineering	<input type="checkbox"/> Verify BOM																																																						
Item ID SR2001	Gear Subassembly																																																							
BOM Type Production	BOM Code 1	Serial Control N																																																						
BOM Qty 1	Std UOM EA	Source Code Make																																																						
Summary Personalize Find View All First 1-5 of 9 Last																																																								
<table border="1"> <thead> <tr> <th>Component</th> <th>Description</th> <th>Op Seq</th> <th>Eff Rev</th> <th>Obs Rev</th> <th>Quantity</th> <th>Std UOM</th> <th>*Per</th> <th></th> </tr> </thead> <tbody> <tr> <td>GR8000</td> <td>Gear, Sugishita</td> <td>50</td> <td>A</td> <td>---</td> <td>1.0000</td> <td>EA</td> <td>Asy</td> <td>+ -</td> </tr> <tr> <td>GR8002</td> <td>Chain, Sugishita</td> <td>50</td> <td>A</td> <td>---</td> <td>1.0000</td> <td>EA</td> <td>Asy</td> <td>+ -</td> </tr> <tr> <td>GR8007</td> <td>Derailleurs, Sugishita</td> <td>40</td> <td>A</td> <td>---</td> <td>1.0000</td> <td>EA</td> <td>Asy</td> <td>+ -</td> </tr> <tr> <td>GR8012</td> <td>Cassette LX145 8 Speed</td> <td>30</td> <td>A</td> <td>---</td> <td>1.0000</td> <td>EA</td> <td>Asy</td> <td>+ -</td> </tr> <tr> <td>GR8200</td> <td>Axle Carrier</td> <td>10</td> <td>A</td> <td>---</td> <td>1.0000</td> <td>EA</td> <td>Asy</td> <td>+ -</td> </tr> </tbody> </table>			Component	Description	Op Seq	Eff Rev	Obs Rev	Quantity	Std UOM	*Per		GR8000	Gear, Sugishita	50	A	---	1.0000	EA	Asy	+ -	GR8002	Chain, Sugishita	50	A	---	1.0000	EA	Asy	+ -	GR8007	Derailleurs, Sugishita	40	A	---	1.0000	EA	Asy	+ -	GR8012	Cassette LX145 8 Speed	30	A	---	1.0000	EA	Asy	+ -	GR8200	Axle Carrier	10	A	---	1.0000	EA	Asy	+ -
Component	Description	Op Seq	Eff Rev	Obs Rev	Quantity	Std UOM	*Per																																																	
GR8000	Gear, Sugishita	50	A	---	1.0000	EA	Asy	+ -																																																
GR8002	Chain, Sugishita	50	A	---	1.0000	EA	Asy	+ -																																																
GR8007	Derailleurs, Sugishita	40	A	---	1.0000	EA	Asy	+ -																																																
GR8012	Cassette LX145 8 Speed	30	A	---	1.0000	EA	Asy	+ -																																																
GR8200	Axle Carrier	10	A	---	1.0000	EA	Asy	+ -																																																

Assembly Item Information

Field or Control	Description
Item ID	<p>Displays the item ID.</p> <p>When you add an EBOM, the assembly item can be pending approval or an approved item, and must contain business unit item attributes. You can add the assembly item information by using the Item Definition and Define Business Unit Item pages in PeopleSoft Inventory. Only owned or consigned items that aren't stage-date controlled can have a bill, and must also have a source code of either <i>Make</i> or <i>Buy</i>.</p> <p>Also, assembly items must use a Standard Cost profile for all their books.</p> <hr/> <p>Note: You can't add the end item to the rework BOM as a component. The system automatically assigns the reworked item as a component when you release a rework production ID in PeopleSoft Manufacturing.</p>

Field or Control	Description
BOM Qty (BOM quantity)	<p>Enter the BOM quantity.</p> <p>When BOMs contain a single-item output, then BOM quantity is a scaling device that enables you to enter a product structure when the end item's specifications are in a base greater than one unit. With BOM Qty, you determine the assembly quantity to which the component's QPA or per order is applied. If the BOM quantity is greater than 1, you enter the component quantity in terms of the BOM quantity. If set to 1, the component quantity is the amount of the component required to make one unit. You can use BOM Qty for batched bills or if you know you will make only a certain quantity of an item at one time.</p> <p>For multiple output BOMs, the BOM quantity must match the primary item's average order quantity (AOQ) as defined on the Define Business Unit Item - Manufacturing: General page. If you change the BOM quantity, the system asks if you want to update the AOQ with the newly entered BOM quantity. Keeping the two quantities in sync ensures correct costing of the output items.</p>
Sort Option	<p>Select an option. Values are:</p> <ul style="list-style-type: none"> • <i>Component</i> • <i>Effectivity</i> • <i>Op Sequence</i> (operation sequence) • <i>Pos Number</i> (position number)

Note: Maintaining BOM information is less restrictive in PeopleSoft Engineering than in PeopleSoft Manufacturing because you can use pending, released, or nonexistent items. PeopleSoft Engineering ensures, however, that all items exist and are approved prior to transferring or copying the BOM back into PeopleSoft Manufacturing for use in manufacturing.

Component Information

Field or Control	Description
Component ID	<p>Enter IDs for the lower-level items that you want to be part of the end item's EBOM. Components can be owned, non-owned, or non-owned and consigned with a source code of <i>Make</i>, <i>Buy</i>, <i>Floor Stock</i>, or <i>Expense</i>.</p> <p>Additionally, all output and component items must use a Standard Cost profile for all their books.</p>
Comp Rev (component revision)	<p>Appears if any component on the bill is under revision control.</p> <p>For items under revision control, you can associate specific component revisions with the assembly item. Depending on how you set business unit level manufacturing options on the MFG Business Unit Options page, the system allows you to leave Comp Rev clear, displays a default value in the Comp Rev field, or requires that you select a component revision for each revision-controlled component.</p> <p>If the system is set up to use component revision by default, the revision column initially displays the current revision. When you enter effective dates, the revision updates with the component revision effective on the date specified.</p> <hr/> <p>Note: If a component is a revision-controlled assembly, you can't enter a revision for the item. The column isn't accessible, and the current revision is always used. This ensures consistency with PeopleSoft Cost Management and PeopleSoft Supply Planning, which use the current assembly revision when exploding assemblies.</p> <hr/>

Field or Control	Description
<p>Op Seq (operation sequence)</p>	<p>Enter where you need the component in the manufacturing or rework process. The operation sequence refers to an operation on the assembly item's routing. For production EBOMs, this is the item's production routing; for rework EBOMs, it's the item's rework routing.</p> <p>The default operation sequence is 0 (the first operation), which means that you need the component at the beginning of the manufacturing process. If you set the operation sequence for all items to 0, the system assumes that all items are needed at the beginning of production and therefore need to be issued at the start of the first operation. If the component's issue method is <i>Issue</i> or <i>Replenish</i>, the system issues the items to the default WIP location for the production area in which the production or rework takes place.</p> <p>When replacing a discontinued (<i>use up</i>) item on the BOM, the obsolete date of the discontinued item may be the projected use up date as calculated by the planning engine.</p>
<p>Eff Rev (effective revision) and Obs Rev (obsolete revision)</p>	<p>If you are using revisions, enter valid revisions.</p>
<p>Eff Date (effective date) and Obs Date (obsolete date)</p>	<p>If you are using effectivity dates, enter these dates for the components of the assembly item. You can view dates by revision, if any exist, but you aren't required to use one.</p> <p>The obsolete date or revision must be later than the effective date. The component is effective from the start date, or the beginning of time, of the effective revision through the end date, or the end of time, of the obsolete revision.</p> <hr/> <p>Note: These fields refer to the effective and obsolete revisions of the assembly, not the component on the assembly.</p> <hr/>
<p>Quantity</p>	<p>Enter the number of each component that you need in the parent assembly to manufacture or rework the specified batch quantity. If the component is serial-controlled, you must enter a whole number.</p> <p>If the quantity is per assembly, the quantity represents the number of that component required to manufacture one end item.</p> <p>If the quantity is per order, then the component quantity is a fixed amount, regardless of the production quantity.</p>

Entering Component IDs

You can add a placeholder for a component item that doesn't yet exist or for which the item number isn't yet known. Do this by entering any value in the **Component ID** field. The system displays the item description placeholder. Placeholder items exist only on the EBOM and aren't automatically added to the inventory item files.

You can maintain placeholder component information, such as effectivity dates or revisions, QPA, reference designators, and documents on the EBOM. When you determine the true item number, replace the placeholder by typing over the placeholder ID. If the placeholder item ID eventually becomes the permanent item ID, you don't need to take any action. Once added, the system displays the item's real description.

These restrictions apply to entering items and components:

- You can't generate costs for a placeholder item.
- A component can't be the same as its parent, and you can't have overlapping effectivity dates for the same component.
- While you can create 99 MBOMs per assembly, Production BOM Code 1 is always the primary MBOM.
- You can't create an EBOM for a non-inventory item or an item that has a source code of *Floor Stock* or *Expense*.
- While components can be non-owned items, assemblies cannot.
- The system doesn't allow staged date controlled items and configured items as components on BOMs.

Components can, however, have any source code except *Planning*.

Note: When adding a component with an item status of *Hold* or *Discontinue*, you receive a warning message. Similarly, when updating components with an item status of *Hold* or *Discontinue*, you receive a warning message at save time. In both cases, the message doesn't prevent you from performing the action. However, if you try to add an inactive item, the system prevents you from adding the item.

Defining the Operation Sequence

You define the operation sequence on the item's routing by using the Routing Definition Summary page. When maintaining the EBOM, you can select any operation on the assembly item's routing, even if you haven't defined the routing. Once you establish the routing, you can select the valid operation sequences for all corresponding routing codes and types by clicking the **Op Seq Detail** button. For MBOMs, the system displays operation sequences only for production routings. For rework BOMs, the system displays operation sequences only for rework routings.

Note: If a master routing is in use, then valid operation sequences include all engineering and manufacturing sequences associated with the item's master routing.

Because a work center is associated with the routing's operation, PeopleSoft Manufacturing uses the operation information to determine the work center to which to deliver the component. A storage area is assigned to every work center. When the component's issue method is *Issue* or *Replenish*, the component is issued to the work center and stocked in and consumed from the work center's WIP location storage area. When the component's issue method is *Kit*, the work center is still the indicator for material delivery.

The production ID, however, is charged directly for the component and is not consumed from the WIP location.

For kit components, when the operation sequence is set to zero, it's assumed that the component item is kitted at the first operation.

If you enter the BOM before the routing, you can return to the BOM Summary page and add the relevant operation sequence after entering the routing.

Note: If the EBOM assembly has a reference or master routing other than itself, then the Op Seq fields reflect the master routing operations on this page and others in this component.

Quantity Precision Rules

To provide greater flexibility when defining EBOMs, the **Quantity** field need not follow the quantity precision rules defined for the item. The system issues a warning if you define a decimal quantity value for an item whose quantity precision value is a whole number.

Not enforcing quantity precision for quantity gives you flexibility that you might need. For example, suppose that one B0004 component is required to make two assembly A0001s. When defining the BOM, the QPA for B0004 is 0.5. If you apply the rounding rules for precision to the QPA, then the system rounds the QPA for B0004 to 1, and thereby inflates the production costs.

You can maintain quantity per with a precision of four places to the right of the decimal. Depending on the installation setting, a calculated QPA (calculated by dividing the quantity per by the BOM quantity) can be defined with a precision from 4 to 10 decimal places. Calculated QPA is determined as: Component QPA/BOM Qty.

For example, if a calculated QPA results in 6.54321, and the installation setting is set to 4 places, the system recognizes this as 6.5432. The system uses this calculated QPA to determine the cost of the assembly items and to plan and schedule components.

Related Links

[Verifying EBOMs Online and Defining Component Revision Settings](#)

"Understanding Component Issue Methods" (PeopleSoft Manufacturing)

[Defining Master Routings](#)

"Quantity Rounding Exceptions in PeopleSoft Manufacturing" (PeopleSoft Manufacturing)

Engineering BOMs - Header: Assembly Attachments Page

Use the Engineering BOMs - Header: Assembly Attachments page (EG_BOM_ATT) to associate attachments with your EBOMs.

Navigation:

Engineering > BOMs and Revisions > Maintain EBOMs and Revisions > Engineering BOMs > Header > Assembly Attachments

Assembly Attachments

<i>Field or Control</i>	<i>Description</i>
File Ext (file extension)	Select the type of media that you want to attach.
	Click the Attachments button to launch the multimedia object attached to the assembly.

Note: You must set up file extensions on the File Locations page. Attachments have no integration or relation to the embedded document management functionality. They are most useful when you aren't using the document management functionality.

Engineering BOMs - Header: Outputs Page

Use the Engineering BOMs - Header: Outputs page (EG_BOM_OUTPUTS) to define EBOM outputs.

Navigation:

Engineering > BOMs and Revisions > Maintain EBOMs and Revisions > Engineering BOMs > Header > Outputs

This example illustrates the fields and controls on the Engineering BOMs - Header: Outputs page. You can find definitions for the fields and controls later on this page.

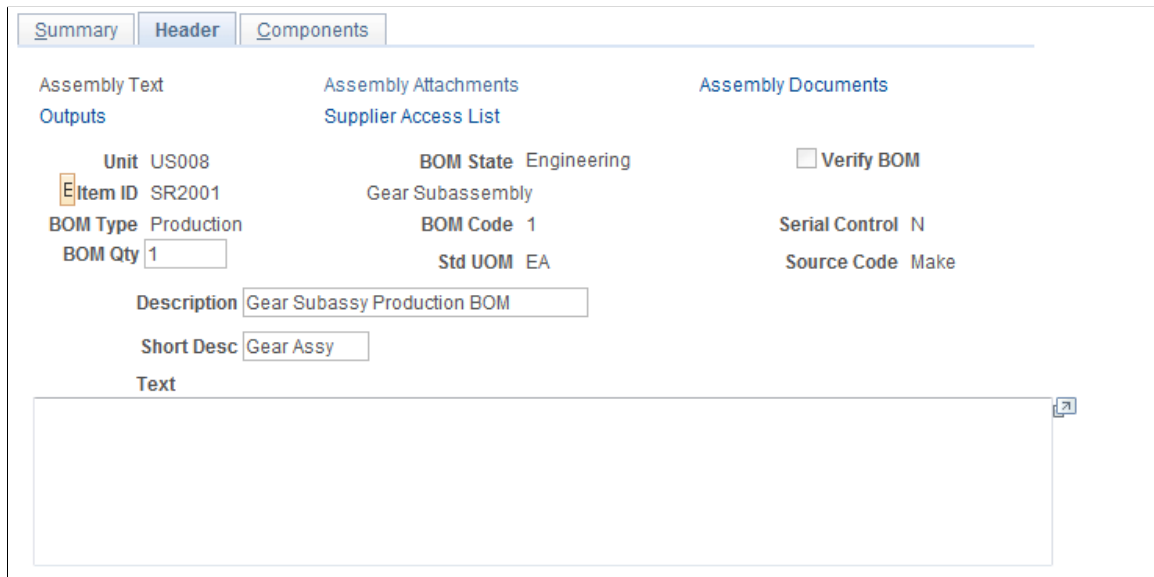

The detail portion of the page minimally contains the end item as the primary item, and you can't delete this. As a result, if you aren't maintaining multiple outputs, you can bypass this page, and the primary item is defined as the only output.

When there is only a primary output for an EBOM, all fields in the row are unavailable for entry or selection. The default settings are:

- Effectivity dates: Beginning to the end of time
- Percentage fields: 100 percent
- Output Qty: 1

If you insert another co-product (not by-product), then the primary's output quantity, allocation percentage, and cost percentage become available. Conversely, if you delete all the co-products from the EBOM, then all the fields on the primary item become unavailable and are set to the defaults.

If you are maintaining a rework BOM, the Output Summary page lists only the reworked item as the end item. You can't define co-products or by-products with rework.

<i>Field or Control</i>	<i>Description</i>
BOM Qty (BOM quantity)	Displays the default value from the BOM Summary page. You can change the quantity in the header portion of this page.

Field or Control	Description
Output Type	<p>Displays an output type for the output item. Output items can't be Floor Stock or Expense items. Waste and Recycle items must be Buy items.</p> <p>Values are:</p> <ul style="list-style-type: none"> • <i>Co-Product</i>: An item that is produced as part of the manufacturing process, along with the Primary output. <p>It shares the cost of the process, and there may be independent demand in PeopleSoft Supply Planning for this item. The system checks whether this item's associated primary is set to itself, the default. It then asks if you want to update the co-product's associated primary to this primary assembly item. For example, when item B is created, its associated primary BOM is set to B. If B is added as a co-product to A, the system asks if it should change B's associated primary to A.</p> <p>Examples of co-products are:</p> <ul style="list-style-type: none"> • Orange juice and orange concentrate in drink processing. • Chicken drumsticks, chicken breasts, and thighs in meat processing. <ul style="list-style-type: none"> • <i>Primary</i>: The EBOM has only one output. • <i>Recycle</i> (by-product): A product that you use as an input to other processes. <p>The by-product is incidental to the process and has a relief (negative) cost. Examples of Recycle by-products are orange pulp and rinds.</p> <ul style="list-style-type: none"> • <i>Waste</i> (by-product): A product that needs disposal. The by-product is incidental to the process and has a disposal (positive) cost. Waste by-products could also have no cost associated with them. There is often no independent demand for by-products.
Output Item	<p>Displays the output item, which must be an existing, inventory, and standard costed item. You can also add by-products and co-products.</p>

Field or Control	Description
Op Seq (operation sequence)	<p>Displays all the operations on all routing codes, not just the primary routing. This field operates in a similar fashion for outputs as it does for the components. The difference is that for components, a nonexistent operation sequence means that it's needed at the first operation; for outputs, a nonexistent operation sequence means that it is generated at the last operation.</p> <p>This field isn't available for input for any co-product items because the co-product is generated only at the last operation. Specify operation sequences for by-products. If the operation sequence specified on the output doesn't exist on the routing selected for production, then the by-product is generated at the last operation on the routing.</p>
Eff Date (effective date) and Obs Date (obsolete date)	<p>These fields appear when the assembly item is revision-controlled by date. For the primary item and any co-products, these fields display the beginning time (01/01/1900 or ---) and the ending time (12/31/2099 or ---), and the fields aren't available for input. Only by-products have accessible effectivity dates.</p>
Eff Rev (effective revision) and Obs Rev (obsolete revision)	<p>These fields appear when the assembly item is revision-controlled by revision.</p>

Field or Control	Description
<p>Output Qty (output quantity)</p>	<p>The batch BOM quantity, which you can change only if there are additional co-products, appears by default as the output quantity for the primary item. This quantity is considered to be in the output item's standard unit of measure (UOM). Enter a quantity for each output.</p> <hr/> <p>Note: Because co-products can have different UOMs, the quantities for all the co-products don't need to add up to the BOM quantity.</p> <hr/> <p>For single output EBOMs (no co-products), the output quantity on the primary item needs to be the same as the BOM quantity. Therefore, if you change the BOM quantity, the system checks to see if the primary item is the only co-product on the EBOM. If so, the system updates the primary item's output quantity to the BOM quantity. If the EBOM already contained additional co-product outputs, and you delete all these additional outputs from the EBOM, the system warns that the primary output quantity will be reset to the BOM quantity. In addition, if BOM quantity is used, it is recommended that you set BOM quantity the same as you set the item's AOQ defined on the Define Business Unit Item - Manufacturing: General page.</p> <hr/> <p>Note: For multiple output items, the BOM quantity for the batch BOM item must match the AOQ defined for the item.</p> <hr/> <p>Note: For by-products (recycle or waste), the BOM quantity is based on the <i>operation start quantity</i>. A QPA for the by-product is calculated by dividing the by-product output quantity by the BOM quantity. The QPA is applied to the operation start quantity to determine the expected output quantity of the by-product.</p> <hr/> <p>This field works the same for outputs as it does with the components. For example, suppose that the BOM quantity is 200 and the production quantity is 400. Then for an <i>Asy</i> quantity code with an output quantity of 3, the output quantity produced is 6.</p> <p>If the quantity code is <i>Ord</i>, the quantity output is 3, regardless of the production quantity. <i>Asy</i> appears by default as the quantity code for the co-products; you can't change it.</p>

Restrictions for Output Type and Output Item

These restrictions apply to the **Output Type** and **Output Item** fields:

- An item cannot be a co-product and by-product on the same BOM.
- A primary item can't be added to or deleted from an EBOM.

The system always adds the assembly or end item for which the BOM is created as the primary output item.

- By-product items must have a *Buy* source code.
- Co-product items must have a *Make* source code.
- Co-product items can't be a phantom or configured items.
- A co-product item can't be the same as the primary item.
- An item can't be both a co-product and a component on the same EBOM.

However, an item can be both a by-product and a component on the same EBOM.

- As long as the effectivity dates don't overlap, the item can exist as a by-product more than once on the BOM at different operations or at the same operation.
- An item can't be both a waste and a recycle by-product on the same EBOM.
- Additional outputs can't be added to rework BOMs, phantom EBOMs, or configured item EBOMs.

Attributes tab

Field or Control	Description
Res % (resource allocation percentage)	Determines how much of the BOM batch quantity each co-product and primary represents. The system uses this percentage at completion time to determine what percentage of the components should be consumed for each co-product.
Cost %	Determines how to distribute the cost across the co-products. The cost percentage indicates the percentage of the total batch costs to be applied to the primary or co-products.

The **Res %** and **Cost %** fields enable you to distribute resource allocation and cost differently for each co-product. For each percentage, the total of all co-product percentages must add up to 100 percent. For the primary item, a value of 100 appears by default as both of these percentages. You can't set the resource and cost percentages to 0.

The following diagram illustrates the impact of the resource allocation percentages within a BOM structure. In this BOM structure, the primary output (6000) equals 60 gallons and co-product (6001) equals 30 pounds. The resource allocation percentages for the primary and co-products don't need to be proportional to the output quantity; you can set them to any percentage as long as the percentages total 100. For this structure, the percentages are set to 60 percent for item 6000 and 40 percent for Item 6001:

Viewing resource allocation percentage on a BOM structure

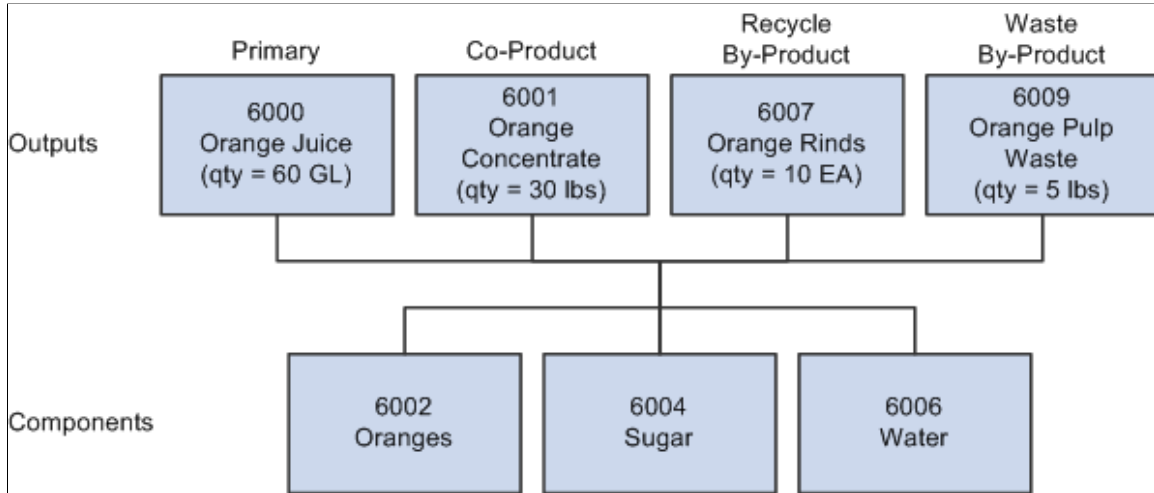

When completing against the co-products, the system can use the resource allocation percentage to determine what proportion of the batch quantity is consumed. In this case, if you did a partial completion of 15 pounds of 6001, then the proportion of the batch quantity completed is:

$$(15/30) \times (40\%) = 20\% \text{ of the batch}$$

This translates into a consumption of 25 percent of the components, earned labor hours, and so on. The system also uses the resource percentage to show, on BOM inquiries, how much material each output uses when exploding down the levels.

The resource allocation percentage enables the outputs to be in different UOMs, because the percentage specifies the relationship between the co-products, the primary, and the batch quantity.

Engineering BOMs - Header: Supplier Access List Page

Use the Engineering BOMs - Header: Supplier Access List page (EG_SS_BOMVND_LST) to access the current list of suppliers who have access to a specific item.

Navigation:

Engineering > BOMs and Revisions > Maintain EBOMs and Revisions > Engineering BOMs > Header > Supplier Access List

This example illustrates the fields and controls on the Engineering BOMs - Header: Supplier Access List page. You can find definitions for the fields and controls later on this page.

Summary			Header			Components			
Assembly Text			Assembly Attachments			Assembly Documents			
Outputs			Supplier Access List						
Unit	US008	BOM State	Engineering	<input type="checkbox"/> Verify BOM					
Item ID	SR2001	Gear Subassembly							
BOM Type	Production	BOM Code	1	Serial Control		N			
BOM Qty	<input type="text" value="1"/>	Std UOM	EA	Source Code		Make			
Suppliers Associated with BOM			Personalize Find View All			First 1-2 of 2 Last			
Supplier SetID	Supplier ID	Supplier Name							
SHARE	SCM0000004	ERNIE'S BIKE SHOP							
SHARE	SPN0000001	Teka Informatica							
BOM Access by Supplier				Send Email to Suppliers					

Field or Control	Description
BOM Access by Supplier	Click to access the BOM Access by Supplier page.
Send Email to Suppliers	Click to send email. The email contains two URLs: <ul style="list-style-type: none"> • A URL that sends the recipient to the Engineering BOM Maintenance - Summary page. • A URL that sends the recipient to the Bill of Material inquiry page in PeopleSoft Engineering.

Related Links

"Header: Supplier Access List Page" (PeopleSoft Manufacturing)

"Header: Send Email to Suppliers - New Message Page" (PeopleSoft Manufacturing)

Engineering BOMs - Components: Component Details Page

Use the Engineering BOMs - Components: Component Details page (EG_COMP_MAINT) to add EBOM component details, attach component text, and manage component documents.

You can also add reference designators, component dimensions, and substitute components.

Navigation:

Engineering > BOMs and Revisions > Maintain EBOMs and Revisions > Engineering BOMs > Components > Component Details

This example illustrates the fields and controls on the Engineering BOMs - Components: Component Details page. You can find definitions for the fields and controls later on this page.

Summary	Header	Components
Component Details		Text
Reference Designators		Attachments
Unit US008		Documents
Item ID SR2001		Dimensions
BOM Type Production		Substitutes
BOM Qty 1		BOM State Engineering
		Verify BOM <input type="checkbox"/>
		Sort Options
		Component
		BOM Code 1
		Serial Control N
		Source Code Make
		Std UOM EA
Components		Find View All
*Component ID GR8000		First 1 of 9 Last
Gear, Sugishita		
Op Seq 50	Quantity 1.0000	Std UOM EA
Eff Rev A	Calc Quantity 1.0000000000	Source Cd Buy
Obs Rev ----	*Per Asy	<input type="checkbox"/> Subcontract Supply
Pos 0	*Yield 100.0000	<input type="checkbox"/> Non-Owned Item
	ECO Number	<input checked="" type="checkbox"/> Teardown
		<input type="checkbox"/> Phantom Item
		<input type="checkbox"/> Serial Control

Component

If a component is a revision-controlled assembly, you can't enter a revision for the item. The field isn't accessible, and the system always uses the current revision. This ensures consistency with PeopleSoft Cost Management and PeopleSoft Supply Planning, which use the current assembly revision when exploding assemblies.

Note: When adding a component with item status of *Hold* or *Discontinue*, you receive a warning message. Similarly, when updating components with an item status of *Hold* or *Discontinue*, you receive a warning message at save time. In both cases, the warning message doesn't prevent you from performing the action.

Field or Control	Description
<p>Pos (position number)</p>	<p>Enter an optional numeric value. This can be, for example, a number that you want to associate with a component on an EBOM drawing or on a list of all components on an EBOM.</p> <p>If the quantity is per assembly, then when the system determines component requirements in PeopleSoft Supply Planning, it divides the quantity per by the BOM quantity, and then multiplies that result by the demand or order quantity.</p> <p>If the quantity is per order, the system uses the quantity per regardless of the demand quantity or order size. In other words, a quantity per order (QPO) is a fixed amount, regardless of the order size. For example, if your QPO is 100, then whether your order size is 1 or 10000, the quantity issued to production is 100.</p> <hr/> <p>Note: The quantity per assembly may be different for original items and their substitutes.</p> <p>To provide greater flexibility when defining EBOMs, the Quantity field need not follow the quantity precision rules defined for the item. The system issues a warning when you define a decimal quantity value for an item whose quantity precision value is a whole number.</p> <hr/>
<p>Phantom Item and Serial Control</p>	<p>Display-only check boxes. The values for the component item appear by default from the PeopleSoft Inventory definition. These fields don't pertain to placeholder items.</p>

Field or Control	Description
Yield %	<p>Displays the expected percentage of usable components within a group of components issued to production. If you know that components can be damaged during the issuing or assembly process, account for that loss here. A component yield of 100 percent assumes that the entire quantity of the component is usable and that none of it will be scrapped. A yield of 90 percent assumes that 10 percent of the component issued is unusable or scrapped.</p> <p>The default value is <i>100</i>.</p> <p>The system considers yield in the planning and cost management processes. For planning, it inflates component requirements to account for expected loss during the assembly process. When scheduling the number of components to use in production, the system divides the required quantity by the yield value to derive the scheduled quantity.</p> <p>For example, suppose that an assembly has a demand of 100 units and the quantity per assembly is 1, with a yield of 90 percent. Then, planning requires 111 components ($100 / .90$). If the expected 10 percent yield loss occurs, 11 components ($111 \times .10$) are unusable, leaving you the original required 100 components. When calculating the cost of the assembly, the system includes the component yield loss, thereby increasing the cost contribution of the component.</p>
ECO Number	<p>Indicates whether the EBOM was updated by using the Engineering BOM Mass Maintenance by ECO process. The number represents the last ECO number that updated the component on the assembly. If no ECO has run against this component on this assembly, the field is blank.</p>
Subcontract Supply (subcontractor supply)	<p>Select if you are subcontracting all or part of your manufacturing process and the outside supplier supplies the component.</p>
Non-Owned Item	<p>Select if you don't own the component, and the customer supplies the component.</p>

Field or Control	Description
Teardown	<p>Select to designate the component as output from a teardown order. Then, when you create a teardown order based on a BOM (as opposed to the original production ID) for this item, the system copies the BOM components to the teardown output list when it releases production. This enables the system to keep teardown outputs in sync with component changes on the MBOM.</p> <p>The Teardown check box applies only to teardown orders and has no effect on production or rework orders. However, the teardown check box on the BOM is also copied to the component list for regular production IDs (original production ID). Therefore, if you teardown based on an original production ID, the check box on the original production ID's component list determines the structure of the teardown output list for the teardown production ID.</p> <p>If you selected Default Teardown BOM Component on the Manufacturing Business Unit Options page, the system designates all components as teardown outputs on all BOMs for all items in this business unit. For all items where this default is in place, the system selects the Teardown check box when adding a component to a BOM. Teardown components can't be subcontractor-supplied, because those components aren't tracked within PeopleSoft Manufacturing.</p> <hr/> <p>Note: Only items with a source code of <i>Make</i> or <i>Buy</i> can be teardown components. Planning, expensed, service, and floor stock items can't be teardown components.</p> <hr/>
Phantom Item and Serial Control	Display fields for the component item; values appear by default from the PeopleSoft Inventory definition. These fields don't pertain to placeholder items.

Subcontracting

EBOMs can handle all subcontracting or non-subcontracting scenarios including scenarios in which:

- You do your manufacturing in-house and you supply all components.
- A subcontractor supplies some components, where outside processing is performed.
- Your customer supplies some components, and you are the subcontractor.

In some instances, you may want to maintain the full product structure of the assembly item, even though you aren't providing all the components necessary to manufacture the item.

Here's a typical scenario:

1. You send a partially completed assembly to a subcontractor.
2. The subcontractor adds a component.
3. The subcontractor returns the altered assembly to you.

This scenario has implications for PeopleSoft Supply Planning, PeopleSoft Manufacturing, and PeopleSoft Cost Management, once the EBOM is copied to manufacturing.

When exploding demand for components stemming from an assembly requirement, the system doesn't include subcontracted supplied components. Scheduling components for production also excludes subcontracted supplied components. These subcontracted components aren't included in the production picking plan and they aren't issued to a WIP location storage area. For the purposes of costing, subcontracted supplied components aren't included in the assembly cost.

Here's a list of valid subcontractor supply and non-owned field combinations:

<i>Subcontract Supply Check Box</i>	<i>Non-Owned Item Check Box</i>	<i>Meaning of the Combination</i>	<i>Valid Combination?</i>
Selected	Selected	A subcontractor supplies the component.	Yes
Deselected	Selected	You are the subcontractor, and your customer supplies the component.	Yes
Deselected	Deselected	You supply the component.	Yes
Selected	Deselected	Not applicable.	No

Related Links

[Engineering BOMs - Summary Page](#)

[Verifying EBOMs Online and Defining Component Revision Settings](#)

"Defining Items at the SetID Level" (PeopleSoft Managing Items)

"Quantity Rounding Exceptions in PeopleSoft Manufacturing" (PeopleSoft Manufacturing)

Engineering BOMs - Components: Attachments Page

Use the Engineering BOMs - Components: Attachments page (EG_COMP_ATT) to associate attachments with your components.

Navigation:

Engineering > BOMs and Revisions > Maintain EBOMs and Revisions > Engineering BOMs > Components > Attachments

Attachments

<i>Field or Control</i>	<i>Description</i>
File Ext (file extension)	Select the type of media that you want to attach.

Note: You must set up file extensions on the File Locations page in Set Up Financials/Supply Chain, Common Definitions.

Attachments have no integration or relation to the embedded document management functionality. They are most useful if you aren't using the document management functionality.

Engineering BOMs - Components: Substitutes Page

Use the Engineering BOMs - Components: Substitutes page (EG_COMP_SUB) to add substitute components.

Navigation:

Engineering > BOMs and Revisions > Maintain EBOMs and Revisions > Engineering BOMs > Components > Substitutes

This example illustrates the fields and controls on the Engineering BOMs - Components: Substitutes page. You can find definitions for the fields and controls later on this page.

The screenshot displays the 'Components' tab of the 'Engineering BOMs - Components: Substitutes' page. It includes a 'Component' section with fields for Component ID (GR8000), Std UOM (EA), Source Cd (Buy), Op Seq (50), Eff Rev (A), and Pos (0). Below this is a 'Substitute Items' table with one row: Priority 1, Sub Item GR8001, Description Gear, Campani, From Date 01/01/2000, To Date 12/31/2099, Rate 1.00000000, Std UOM EA.

Component

<i>Field or Control</i>	<i>Description</i>
	Click the Copy BU Substitute Items button to copy business unit level substitutes to the BOM level.

Substitute Items

<i>Field or Control</i>	<i>Description</i>
Sub Item (substitute item)	<p>Select the item that you want to add.</p> <p>Substitute items must be unique for the item. You can't enter the same item twice as a substitute with different dates. For example, Substitute 1000 with effective dates from 01/01/99 to 02/01/99 and Substitute 1000 with effective dates from 02/01/00 to 08/30/00 couldn't be substitutes for the same item. You need to define a different substitute for the second set of effective dates.</p> <hr/> <p>Note: A substitute item cannot be a phantom item. Also, where substitutes exist, you cannot change the item to a phantom.</p> <hr/> <p>Note: If no substitute items are defined for an item designated as <i>Discontinued</i>, there may be a shortage of that item if demand exceeds existing quantity on hand. If a substitute is defined for that item, PeopleSoft Supply Planning suggests the substitute when the quantity on hand for the discontinued item runs out.</p>
Std UOM (standard unit of measure)	Displays the standard UOM, which can be different for the substitute and the original component.

Copying and Transferring EBOMs

You can easily copy or transfer EBOMs. Copying EBOMs is useful when you want to copy an existing item's BOM to a different item's BOM. It also allows *same as except* type functionality. PeopleSoft Engineering transfers are most useful for transferring several BOMs that are associated with a change between manufacturing and engineering.

This topic discusses how to copy and transfer EBOMs.

Pages Used to Copy and Transfer EBOMs

<i>Page Name</i>	<i>Definition Name</i>	<i>Usage</i>
Copying Engineering BOMs Page	EG_BOM_COPY	Copy EBOMs.
Copy Engineering BOM Detail Page	EG_BOM_COPY_DET	Provide a larger view of the BOM that you are copying.

Page Name	Definition Name	Usage
<u>Copy Outputs Page</u>	EN_BOM_COPY_OUT	Copy engineering outputs.
<u>Transfer Selection Page</u>	EG_ENGTRNS_REQ	Define transfer criteria for BOMs and routings.
<u>ECO Selection Page</u>	EG_ENGTRNS_REQ2	Define the ranges of ECOs by which you want to transfer BOMs, routings, or both.
<u>Assembly Selection Page</u>	EG_ENGTRNS_REQ3	Make engineering transfers by assembly item.

Copying Engineering BOMs Page

Use the Copy Engineering BOMs page (EG_BOM_COPY) to copy EBOMs.

Navigation:

Engineering > BOMs and Revisions > Maintain EBOMs and Revisions > Copy EBOMs > Copy Engineering BOMs

This example illustrates the fields and controls on the Copy Engineering BOMs page. You can find definitions for the fields and controls later on this page.

The screenshot shows the 'Copy Engineering BOMs' page with the following sections:

- Source BOM:**
 - *From/To: Manufacturing to Engineering
 - *Unit: US001
 - *Item ID: [Empty]
 - *BOM Type: Production
 - BOM Code: 1
 - Eff Date: 01/01/19
 - Std UOM: [Empty]
 - All Dates/Revs
- Target BOM (BOM2):**
 - *Unit: US001
 - *Item ID: [Empty]
 - BOM Code: 1
 - Std UOM: [Empty]
- Component Details Table:**

Copy	Copy Sub	Component ID	Description	Comp Rev	Op Seq	Pos Nbr	Effective	Obsolete
<input checked="" type="checkbox"/>	<input type="checkbox"/>					0		

Source BOM

<i>Field or Control</i>	<i>Description</i>
From/To	<p>Select from the list. Values are:</p> <ul style="list-style-type: none"> • <i>Manufacturing to Engineering:</i> Use to begin making design changes to existing MBOMs. • <i>Engineering to Manufacturing:</i> Use to copy engineering changes to manufacturing and freely include or exclude components using the Same as Except functionality on the Copy Engineering BOM Detail page. <p>You control the ability to copy EBOMs to MBOMs with the Engineering Options page. The assembly item and all of its components must be approved items in PeopleSoft Inventory before you can copy the BOM to manufacturing.</p> <ul style="list-style-type: none"> • <i>Engineering to Engineering:</i> Use to copy EBOMs from one business unit or item ID combination to another, to streamline operations. <p>Alternatively, if different items have similar structures, you can copy the structure of one item to another within the same business unit.</p>

During the copying process, you can include or exclude certain components and substitutes. Using Define Engineering Routings pages, you can then change the new structure as needed.

Note: The BOM type of the target BOM (BOM2) and the source BOM must be the same. You don't enter the BOM type in the **Target BOM (BOM2)** group box.

To enter the target BOM (BOM2):

1. Enter as the target BOM (BOM2) the business unit, item ID, and BOM code to which you are copying.

The item must be a valid Make or Buy item in the target business unit. You can't copy a BOM to a Floor Stock or Expensed item.

2. (Optional) Select the Copy Engineering BOM Detail tab to copy assembly and component text, documents, and attachments.

If you are copying a source assembly or end item that's revision-controlled to a target that's a non-revision-controlled item, then the system uses the source component's revision effectivity dates to determine the effectivity and obsolete dates of the target item's components. The target BOM also updates with any component revisions specified on the source bill.

Note: You can copy assembly and component documents for the same item from one BOM code to another. You can't, however, copy assembly and component documents for different items: in this latter case, the Copy Documents fields are unavailable for entry or selection.

3. Click the **Save** button.

If the specific BOM already exists at the target business unit, a message asks whether to overwrite the existing BOM with the information that you are copying. If you overwrite the existing BOM, the system deletes the BOM in the target business unit and adds the source BOM.

Note: You can't copy a BOM to a target business unit or item ID if the assembly item or any of its components isn't defined in the target. If one or more components don't exist in the target business unit, you can cancel the selection for those components, and then add the balance of the BOM. Then, you can add the missing components in the target business unit and use the BOM maintenance pages to complete the BOM structure.
You can't copy a BOM to itself.

4. Click the **Edit BOM** button to access the appropriate BOM Summary page, where you can edit attributes on the target BOM (BOM2).

Related Links

[Engineering BOMs - Summary Page](#)

Copy Engineering BOM Detail Page

Use the Copy Engineering BOM Detail page (EG_BOM_COPY_DET) to provide a larger view of the BOM that you are copying.

Navigation:

Engineering > BOMs and Revisions > Maintain EBOMs and Revisions > Copy EBOMs > Copy Engineering BOM Detail

This example illustrates the fields and controls on the Copy Engineering BOM Detail page. You can find definitions for the fields and controls later on this page.

The screenshot shows the 'Copy Engineering BOM Detail' page. At the top, there are three tabs: 'Copy Engineering BOMs', 'Copy Engineering BOM Detail' (selected), and 'Copy Outputs'. Below the tabs is a section for 'Target BOM (BOM2)' with fields for 'Unit' (US001), 'BOM Code' (1), 'Item ID', and 'Std UOM'. An 'Edit BOM' button is next to the BOM Code field. Below this is the 'Copy Options' section, which includes several checkboxes: 'Copy Assembly Text', 'Copy Component Text', 'Copy Assembly Att', 'Copy Component Att', 'Copy Assembly Docs', and 'Copy Component Docs'. There are also 'View Source' and 'View Target' buttons, a 'Same as Except' dropdown menu, and an 'Apply' button. At the bottom is the 'Component Details' table with columns for Copy, Copy Sub, Component ID, Description, Comp Rev, Op Seq, Pos Nbr, Effective, and Obsolete. The table shows one row with a checked 'Copy' checkbox and a value of '0' in the 'Pos Nbr' column. Navigation controls like 'Personalize', 'Find', 'View All', and 'First 1 of 1 Last' are visible at the top right of the table.

Data on this page appear by default from the Copy Engineering BOMs page, and the fields operate the same as the fields on that page.

You can copy any assembly and component text, attachment, or document.

Note: You can copy documents only if you select identical source BOM and target BOM (BOM2) item IDs. When you copy a BOM, the system creates an audit of the copy including date, time, and user who performed the copy.

Field or Control	Description
Same as Except	<p>Select a value to indicate how you want the BOM copied. You can use the Same as Except values in any combination. For example, you can initially select <i>Exclude All</i>, click Apply, and then select <i>Include Item Range</i>. You can also select <i>Include/Exclude Item Range</i> multiple times, clicking the Apply button after each selection, to include or exclude chunks of items. The effect is cumulative, not exclusive.</p> <p>Values are:</p> <ul style="list-style-type: none"> • <i>Exclude All</i>: The system copies no components to the target BOM. <p>You can still select a component's Copy check box to select specific components or component revisions. You can also select a substitute's Copy Sub check box to select specific substitutes.</p> <hr/> <p>Note: To exclude a range of dates or revisions, select <i>Exclude All</i>, and then include portions (by revision or date) that you want.</p> <hr/> <ul style="list-style-type: none"> • <i>Exclude Item Range</i>: The system doesn't copy the range of component IDs that you enter in the edit box. • <i>Exclude Pos Range</i> (exclude position range): The system doesn't copy the range of position numbers that you enter in the edit box. • <i>Include All</i>: The system marks all components on the source BOM to copy. <p>You can still deselect a specific component's Copy check box or select <i>Exclude All</i> to deselect all check boxes.</p> <ul style="list-style-type: none"> • <i>Include Item Range</i>: Works like the exclude feature, except that you enter the range of items that you want to copy. • <i>Include Pos Range</i>: Works like the exclude feature, except that you enter the position numbers that you want to copy. • <i>Include Date Range</i>: Enables you to copy all components that are in effect between the specified dates. • <i>Include Revision Range</i>: Enables you to copy all components that are in effect between the specified revisions.
Apply	Click after you select your same as except values.
View Source	Click to have the system display items that you copy and the copy choices that you make.
View Target	Click to view how the BOM will look after the copy.

Related Links

[Transferring BOMs and Routings](#)

Copy Outputs Page

Use the Copy Outputs page (EN_BOM_COPY_OUT) to copy engineering outputs.

Navigation:

Engineering > BOMs and Revisions > Maintain EBOMs and Revisions > Copy EBOMs > Copy Outputs

Data on this page appears by default from the Copy Engineering BOMs page. Fields on this page operate the same as fields on the page and fields on the Copy Engineering BOM Detail pages.

Component Details

<i>Field or Control</i>	<i>Description</i>
Copy	Select to designate, at the row level, that you want an output row copied from the source to the target BOM. The primary item and co-products are always copied.

Transferring EBOMs

While the copy BOM functionality is useful when same as except copies are required, it copies only one BOM at a time. Using the engineering transfers BOMs functionality enables you to transfer at once multiple single-level BOMs within a business unit. You can transfer BOMs:

- As part of the ECO process.
- By assembly items: Either a list or range of items.

You can transfer BOMs from engineering to manufacturing or from manufacturing to engineering. Transferring BOMs from engineering to manufacturing requires that all BOM items exist and are approved. So, while you can set up an item as pending, or even use placeholders when you design an EBOM, the item must be defined and approved before it's transferred to manufacturing.

Deleting EBOMs

This topic discusses how to delete EBOMs.

Page Used to Delete EBOMs

<i>Page Name</i>	<i>Definition Name</i>	<i>Usage</i>
Delete EBOMs Page	EG_BOM_DELETE	Delete EBOMs for any or all assembly items.



Delete EBOMs Page

Use the Delete EBOMs page (EG_BOM_DELETE) to delete EBOMs for any or all assembly items.

Navigation:

Engineering > BOMs and Revisions > Maintain EBOMs and Revisions > Delete EBOMs > Delete EBOMs

This example illustrates the fields and controls on the Delete EBOMs page. You can find definitions for the fields and controls later on this page.

<i>Field or Control</i>	<i>Description</i>
Search	Click to display the list of production or rework BOMs for the assembly items that you are deleting.
	Click the Select All button to select each Delete? Check box next to each assembly.
	Click the Deselect All button to deselect each Delete? Check box next to each assembly.

You can delete production or rework BOMs.

For each assembly, the system deletes all EBOM components regardless of effectivity date or revision. All assembly EBOMs scheduled for deletion have header, outputs, related text, attachments, components, and reference designators deleted.

If you leave the **BOM Code** field blank, then the system deletes all BOMs, regardless of code. To delete only a specific BOM code, enter a value in the **BOM Code** field.

The Delete Engineering BOMs process checks and warns you of these conditions:

- BOM is used in a production area.
- Production exists in the *Entered* status.
- Production is planned, but a BOM and routing haven't yet been frozen for production.
- Assembly item is present on pending or approved ECOs that haven't been released to manufacturing.

Checking the EBOM Verification Status

This topic discusses how to check EBOM verification status.

Pages Used to Check the EBOM Verification Status

<i>Page Name</i>	<i>Definition Name</i>	<i>Usage</i>
EBOM Looping Verification Page	EN_BOM_VERIFY_REQ	Check EBOMs for unwanted loops.
Delete Verification Details Page	EN_BOM_VERIF_DEL	Delete records created by the EBOM Verification Request process (ENPBEXPV) by process instance.
EBOM Verification Status Page	EN_BOM_VERIFY_STAT	View, on a summary level, a list of all verified EBOMs or a list of all looping EBOMs discovered as a result of running the Verification Request page.
BOM Verification Detail Page	EN_BOM_VERIFY_DET	View a detailed list of all looping BOM components discovered as a result of running the BOM Verification Request page.

EBOM Looping Verification Page

Use the EBOM Looping Verification page (EN_BOM_VERIFY_REQ) to check EBOMs for unwanted loops.

Navigation:

Engineering > BOMs and Revisions > Identify Looping EBOMs > EBOM Looping Verification

This example illustrates the fields and controls on the EBOM Looping Verification page. You can find definitions for the fields and controls later on this page.

EBOM Looping Verification

Run Control ID RUN01
Report Manager
Process Monitor
Run

Request Parameters

Process Frequency

Once

Always

Don't Run

*Request ID

*Unit

From Item ID to

BOM Code All Dates/Revs Eff Date

Depth Delete Rows, If No Errors

Field or Control	Description
BOM Code	Enter the code for the BOM that you want to verify.
Depth	Determine how many levels to verify.
Delete Rows, If No Errors	Select to delete BOM explosion table records. The verification request process adds a series of records to the BOM Explosion table. These records take up space and are useless, if there are no looping BOMs. You can also use the Delete Verification Details page to save space.

The EBOM verification COBOL SQL process (ENPBEXPV) checks for loops within EBOM structures only. Once you copy the EBOM to manufacturing, run the BOM verification within PeopleSoft Manufacturing to verify the BOM within manufacturing.

Instead of running this process, you can use Online BOM Verification to check for loops. You set the Online BOM Verification option at the manufacturing business unit level with the MFG Business Unit Options page. However, to improve BOM maintenance performance when BOMs are complex and deep, use the scheduled verification process and set Online BOM Verification to Never Verify Online.

EBOM Looping Verification looks at just the primary EBOM and routing, when exploding at levels greater than 1. If there is more than one way to make a specific co-product output, tell the system which EBOM is the primary way to make that co-product and, therefore, which EBOM to verify for that co-product. To tell the system which EBOM to verify, select an associated primary BOM on the Define Business Unit Item - Manufacturing: General page.

Note: Both MBOMs and EBOMs use the same associated primary; there isn't one specific to MBOMs.

Output Example

The following diagram illustrates how two different processes could have the same output. In this example, B is an output on two different processes:

BOM Output Example

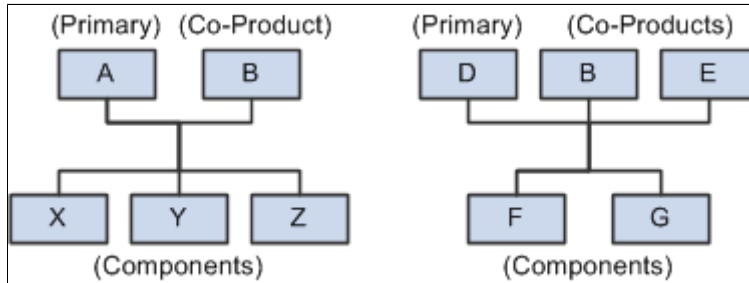

Consider the two structures:

- In the first structure, A is the primary (item), with B as the co-product, and X, Y, and Z are components.
- In the second structure, D is the primary, and B and E are co-products, with F and G as the components.

Because there are two ways to make the same product (B), you need to decide which structure to use when exploding to lower levels. Therefore, you need to signify a primary structure associated with each item that may exist as a co-product, but not as a primary. To do this, assign an associated primary EBOM.

When exploding to lower levels, the system checks whether there is an associated primary defined for this item. If there is an associated primary item, the system uses it to explode to lower levels.

If exploding EBOM code 2 for the co-product, and an associated primary was defined, then the system uses EBOM code 2 for the associated primary, also.

For instance, if the system is exploding B (in the diagram) for EBOM code 2, and A is the associated primary, then the system looks for an item with an EBOM code 2 to explode. If EBOM code 2 doesn't exist for A, then the explosion stops for this item, and the system generates an error. This same logic is used for BOM verification, inquiries, and costing.

You receive a message only if the system finds a looping BOM. You can view the results of the verification process by using the BOM Verification Status page.

Related Links

"Assigning Associated Primary BOMs" (PeopleSoft Manufacturing)

Delete Verification Details Page

Use the Delete Verification Details page (EN_BOM_VERIF_DEL) to delete records created by the EBOM Verification Request process (ENPBEXPV) by process instance.

Navigation:

Engineering > BOMs and Revisions > Identify Looping EBOMs >Delete BOM Verification Detail

This example illustrates the fields and controls on the Delete Verification Details page. You can find definitions for the fields and controls later on this page.

Unit	Process Instance	Delete?
		<input type="checkbox"/>

The verification request process adds a series of records to the BOM Explosion table. These records take up space and are useless if there are no looping BOMs. You can use this page to delete these records by process instance.

EBOM Verification Status Page

Use the EBOM Verification Status page (EN_BOM_VERIFY_STAT) to view, on a summary level, a list of all verified EBOMs or a list of all looping EBOMs discovered as a result of running the Verification Request page.

Navigation:

Engineering > BOMs and Revisions > Identify Looping EBOMs > EBOM Verification Status

This example illustrates the fields and controls on the EBOM Verification Status page. You can find definitions for the fields and controls later on this page.

EBOM Verification Status

Run Control ID: RUN01

Instance: 10538

Unit: US008

Option

All BOM paths verified
 BOMs with errors only

Search

BOM Verification Detail				
Looping BOM/Top Level Assembly	Description	Lower Level Assy Item	Component ID	BOM Code
MT2000	Professional Road Bike, Womans	MT2000	MT2000	1
MT2000	Professional Road Bike, Womans	MT2000	FR7002	1
MT2000	Professional Road Bike, Womans	MT2000	FR7005	1
MT2000	Professional Road Bike, Womans	MT2000	FR7012	1
MT2000	Professional Road Bike, Womans	MT2000	FS3000	1
MT2000	Professional Road Bike, Womans	MT2000	FS3001	1

Field or Control	Description
All BOM paths verified	Select to enable the system to display all verified BOMs by top-level assembly.
BOMs with errors only	Select to enable the system to display all looping BOMs, along with the specific looping lower-level assembly and component items.
Search	Click to check for looping BOMs. If the system does not detect any loops, a message appears. If the system detects any looping BOMs, they appear at the bottom of this page.
Details	Click for any top-level assembly with errors to access the BOM Verification Detail page.

BOM Verification Detail Page

Use the BOM Verification Detail page (EN_BOM_VERIFY_DET) to view a detailed list of all looping BOM components discovered as a result of running the BOM Verification Request page.

Navigation:

Manufacturing Definitions > BOMs and Revisions > Identify Looping BOMs > BOM Verification Status > BOM Verification Status

Click a **Detail** link.

Field or Control	Description
Lvl (level)	Indicates the level where the loop in a BOM occurred.
Component ID	Indicates the specific component where the loop in a BOM occurred.
BOM Code	Indicates the BOM code for the BOM in which the loop occurred.
Pos Nbr (position number), Op Seq , Eff Date , Obs Date , and Associated Primary BOM	This additional information appears for the BOM in which the loop occurred.

Chapter 5

Making Mass Engineering Bill of Material Changes

Understanding Mass BOM Changes

This topic discusses:

- Mass BOM changes.
- Example scenarios for mass BOM changes.

Mass BOM Changes

Engineering and production departments must apply multiple additions and changes directly to BOMs. Engineering can use this functionality to more easily implement approved changes on an engineering change order (ECO). Production also needs this functionality because not all changes go through engineering. You can also apply mass maintenance directly to manufacturing BOMs.

PeopleSoft Engineering mass maintenance enables you to apply, in a single process, the same set of changes, by ECO or MMC, to many manufacturing or engineering BOMs. For example, you can change all occurrences of one component for another or add components to an assembly.

The BOM mass maintenance code setup page enables you to define an MMC that can then be applied to an assembly range, assembly list, or an ECO-affected item. An MMC enables you to define a specific set of component changes such as reference designator and component dimension changes. A component can be added, and associated BOM information can be changed. The MMC also enables you to change or add specific multiple output values. You can even generate automatic revisions for revision-controlled items. You can then place the MMCs on ECOs and later run the MMC changes for that particular ECO. You can also view all BOM mass maintenance exceptions.

See [Creating and Maintaining ECOs](#).

Note: In addition to generating mass maintenance changes to BOMs, the mass maintenance process also enables you to automatically create new revision numbers based on a revision scheme that you define for the business unit.

Related Links

"Maintaining BOMs by Revisions or Effectivity Dates" (PeopleSoft Manufacturing)

Example Scenarios for Mass BOM Changes

You can complete a mass update of BOMs in several ways. You can mass update engineering BOMs and manufacturing BOMs; in either case, you can choose whether to use ECOs. For manufacturing

BOM changes, you can change the BOMs directly. For engineering BOM changes, use the transfer functionality. In addition, you can update BOMs directly, or you can stage and validate mass maintenance BOM changes so that you can then review and modify the mass-maintained version prior to completing the updates to your production BOM.

The following sections present some BOM update scenarios:

Scenario 1: Updating Engineering BOMs With or Without Using ECOs

To update engineering BOMs (EBOMs) using ECOs:

1. Create an ECO listing the affected assemblies.

For example, if you are obsoleting a component, you can identify and create the list of affected assemblies by using the where-used search within ECO maintenance.

2. If the BOMs are in manufacturing, use this ECO to transfer the BOMs to engineering.
3. If not already done, create the MMC and associate it with affected assemblies within ECO maintenance.

This step is required because the process to run all MMCs for the ECO is done by ECO number.

4. Process BOM mass maintenance by ECO and specify EBOMs.

To update engineering BOMs using MMCs:

1. If the BOMs are in manufacturing, transfer to engineering the assemblies that you want to change by item range or list.
2. If not already done, create the MMC.
3. Process BOM mass maintenance by MMC, and specify the MMC, engineering BOMs, and the assemblies by item range or list.

Scenario 2: Updating Engineering BOMs for Use-Up Items Using ECOs

With use-up functionality (using substitute items on the BOM), you can use an ECO to make permanent BOM changes once you know the phase-out date of the component. For example, say that item A is discontinued, item B replaces item A on five of six existing BOMs, and item C replaces item A on one of six existing BOMs. In this case, you most likely will have already defined item B as a valid substitute for component A on these six BOMs. Once the use-up date is determined (based on information from planning), you can use this information to make changes on the BOM.

For example, you could:

- Create an ECO (ECO-A, for example) and place all six items on the ECO.

Run Process Engineering Transfer to copy the MBOMs (manufacturing) to EBOMs that specify ECO-A.

- Create a MMC (MMC-100, for example).

For sequence 10, for example, specify search criteria to uniquely identify the five assemblies for which you will replace component item A with item B. For sequence 20, specify search criteria that uniquely identify the one assembly for which you will replace component item A with item C. When

defining the effective date of new components B and C, you can specify the scheduled date within the MMC. This indicates the scheduled date for the ECO. Or, if you already know the exact date of the changeover, you can specify that date as the effective date.

- Place MMC-100 on the ECO lines associated with the six assemblies to be updated.
- When the quantity on hand goes to zero, using the use-up information from planning, you can use this date as the ECO schedule date.
- Run Process Mass Maintenance by ECO to make the component changes for you.
- Approve ECO-A.
- Run Process Engineering Transfer to copy the EBOMs to MBOMs that specify ECO-A.

Note: In the second item of this scenario, be careful to uniquely identify the five assemblies versus the one assembly. Because you are associating the same MMC with all six assemblies, make sure that all six won't have item A replaced with item B and item A replaced with item C, or both. An alternative solution is to create two separate MMCs.

For example, create MMC-100, which defines the replacement of component item A with item B, and create MMC-200, which defines the replacement of component A with item C. Then place MMC-100 on the ECO lines of the five assemblies for which item A should be replaced with item B. On the other assembly, place MMC-200 to replace item A with item C.

Scenario 3: Updating Manufacturing BOMs Using ECOs

You can update MBOMs using ECOs in two ways. You can transfer the MBOMs to EBOMs, make the changes, and transfer them back to manufacturing. Alternatively, you can make the changes directly to the MBOMs within PeopleSoft Manufacturing.

The transfer scenario is:

1. Create an ECO with the assemblies on it that you want to change.
2. Use the ECO that you just created to transfer the BOMs to engineering.
3. If not already done, create the MMC and document it on the ECO.

This step is required because the process to run all MMCs for the ECO is done by ECO number.

4. Process BOM mass maintenance by ECO and specify engineering BOMs.
5. Approve the ECO.
6. Use this ECO to transfer the BOMs back to manufacturing.

To directly update MBOMs in manufacturing using ECOs:

1. Create an ECO with the assemblies that you want to change on it.
2. If not already done, create the MMC and document it on the ECO.

This step is required because the process to run all MMCs for the ECO is done by ECO number.

3. Approve the ECO.

4. Process BOM mass maintenance by ECO and specify manufacturing BOMs.

Scenario 4: Updating Manufacturing BOMs Using MMCs Without ECOs

You can also update MBOMs using MMCs in two ways. You can transfer the MBOMs to EBOMs, make the changes, and transfer the manufacturing BOMs back. Alternatively, you can make the changes directly to the manufacturing BOMs within production.

The transfer scenario is:

1. Transfer the BOMs, by item range or list, to engineering.
2. If not already done, create the MMC.
3. Process BOM mass maintenance by MMC, and specify engineering BOMs.
4. Transfer the assemblies, by item range or list, back to manufacturing.

To directly update manufacturing BOMs in production, using MMCs:

1. If not already done, create the MMC.
2. Process BOM mass maintenance by MMC, and specify the MMC, manufacturing BOMs, and the assemblies by item range or list.

Defining Engineering BOM MMCs

To define engineering BOM MMCs, use the BOM Mass Maintenance component.

This topic provides an overview of BOM MMCs, lists prerequisites, and discusses how to define BOM MMCs.

Pages Used to Define BOM MMCs

Page Name	Definition Name	Usage
BOM Mass Maintenance Codes - Search Page	EN_BOM_MMC_SRCH	Identify outputs or components, and therefore BOMs, to change.
Component Dimensions - Search Page	EN_BOM_MMC_DIM_SP	Enter component dimension search criteria. BOM Mass Maintenance Codes - Search Page
Reference Designators - Search Page	EN_BOM_MMC_REF_SP	Enter reference designator search criteria.
Component Substitutes - Search Page	EN_BOM_MMC_SUB_SP	Search for substitutes everywhere that they are used.

Page Name	Definition Name	Usage
Assembly/Component Matches Page	EN_BOM_MMC_VW_SP	View the number of assemblies that match the search criteria that you have entered. Also view matching BOMs.
BOM Mass Maintenance Codes - Change Page	EN_BOM_MMC_NEW	Specify new component values, after you have selected the set of components that you want to change using the Search page.
Component Dimensions - Change Page	EN_BOM_MMC_DIM2_SP	Make mass changes to component dimensions. BOM Mass Maintenance Codes - Change Page
Reference Designators - Change Page	EN_BOM_MMC_REF2_SP	Make mass changes to reference designators.
Component Substitutes - Change Page	EN_BOM_MMC_SUB2_SP	Change a substitute everywhere that it is used.
BOM Mass Maintenance Codes - Add Page	EN_BOM_MMC_ADD	Add components or outputs to assemblies. The system adds these components or outputs to each BOM identified by the values that you entered on the Search page. Use the Process BOM Mass Maintenance pages to designate, at a later time, the assemblies to be affected by these changes.
Component Substitutes - Add Page	EN_BOM_MMC_DIM3_SP	Add component dimensions, if you are adding by the <i>Component</i> sequence type.
Reference Designators - Add Page	EN_BOM_MMC_REF3_SP	Add reference designators, if you are adding by the <i>Component</i> sequence type. Component Substitutes - Add Page
Component Substitutes - Add Page	EN_BOM_MMC_SUB3_SP	Add a substitute everywhere that it is required. Component Substitutes - Add Page

Related Links

"Quantity Rounding Exceptions in PeopleSoft Manufacturing" (PeopleSoft Manufacturing)

Understanding Engineering BOM MMCs

With the BOM Mass Maintenance component, you can create and maintain BOM MMCs. You can specify multiple BOM component or output changes and additions, including substitute items. An MMC consists of search pages that enable you to identify existing components that will be affected, change pages that enable you to change instances of those components on specific BOMs, and Add pages that allow for the introduction of new components and detail information. After you have used these pages to define MMCs, you can then implement these changes directly using the Process BOM Mass Maintenance pages. Alternatively, you can associate MMCs to engineering change orders (ECOs) and implement the changes by ECO processing.

Note: To maintain components for revision-controlled BOMs en masse by using mass changes, you must enter effective and obsolete dates for the revision within these pages, regardless of whether the revision is controlled by revision name or by effectivity date.

Prior to accessing any mass maintenance code pages, you must select a business unit and MMC. The MMC value can be automatically generated.

Note: Any MMCs created in PeopleSoft Engineering are available only in engineering; any MMCs created in PeopleSoft Manufacturing are available only in manufacturing.

Note: To provide greater flexibility when defining EBOMs, the **Quantity** field does not need to follow the quantity precision rules defined for the item. A warning is issued if you define a decimal quantity value for an item whose quantity precision value is a whole number. This is an example of when you may need the quantity precision flexibility. If one B0004 component is required to make two assembly A0001s, then when defining the BOM, the QPA for B0004 would be 0.5. If you applied the rounding rules to the QPA, then it would round the QPA for B0004 to 1, and thereby inflate the production costs.

Mass BOM Changes Example

To better understand how you can use these pages to effect mass change, let's look at an example.

To obsolete a component on several BOMs and introduce another component in its place:

1. Create an MMC code by entering the search criteria (on the BOM Mass Maintenance Codes - Search page) that identifies the component that you want to obsolete.
2. On the BOM Mass Maintenance Codes - Change page, specify the date that the component is to become obsolete (or choose one of the available options).
3. Add the new component information on the BOM Mass Maintenance Codes - Add page, including required information, such as operation sequence and effective date for the new component.
4. Add additional component information with the dimensions, reference designator, or substitutes links, as required.
5. Process the BOM mass maintenance and isolate the BOMs to be changed by specifying the appropriate ECO.

If you're using MMCs without ECOs, isolate the BOMs to be changed by specifying the assembly item list or range.

Prerequisites

Prior to making BOM mass maintenance changes, define these in PeopleSoft Engineering:

- Appropriate assemblies.
- BOMs.
- If you're using ECRs, ECOs and MMCs associated with ECOs.

You also must define as revision-controlled with automatic revisions any items for which you plan to create automatic revisions.

BOM Mass Maintenance Codes - Search Page

Use the BOM Mass Maintenance Codes - Search page (EN_BOM_MMC_SRCH) to identify outputs or components, and therefore BOMs, to change.

Navigation:

Engineering > BOMs and Revisions > EBOM Mass Changes > BOM Mass Maintenance Codes > Search

This example illustrates the fields and controls on the BOM Mass Maintenance Codes - Search page. You can find definitions for the fields and controls later on this page.

The screenshot displays the 'BOM Mass Maintenance Codes - Search' page. At the top, there are tabs for 'Search', 'Change', and 'Add'. Below the tabs, the 'Business Unit' is set to 'US008' and 'Mass Maint Code' is 'NEXT'. There is an 'Auto Revision' checkbox which is unchecked. A search field for '*Description' is present. The main search area is titled 'Mass Maintenance Sequence' and includes a 'Find | View All' button and navigation controls 'First 1 of 1 Last'. The search criteria are: '*Mass Maint Seq' set to '10', '*Descr' is empty, and '*Sequence Type' is set to 'Component'. Below this is a section titled 'Where Search Values Are' with a 'Find | View All' button and 'First 1 of 1 Last' navigation. This section contains several search fields: 'Component ID', 'Comp Rev', 'Op Seq', 'Pos', 'Eff Date', 'Quantity', 'Sub Supply', 'Obs Date', 'Per', 'Non-Owned', 'Yield', and 'Teardown'. At the bottom left, there is a 'Search Seq' set to '1' and a checked 'Update Flag' checkbox. Other options like 'Dimensions', 'Ref Desigs', and 'Substitutes' are listed at the bottom.

Before you associate changes or additions to an MMC, identify the outputs, components, or component revisions (and, therefore, BOMs) to change. When adding components, use this page to further identify the BOMs to which the new component should be added. For example, you may want to add component ID LT5001 only to BOMs that already have a component ID called LT5000 and a 12/31/97 obsolete date, or perhaps where you already have component ID LT5000 and LT5001 defined. Similarly, you can use this page to further identify the BOMs to which the new output should be added.

Note: In this component, the fields that you see vary depending on your selection in the **Sequence Type** field. The page examples in this section are based on selecting *Component* in the **Sequence Type** field. If you select *Output*, the system doesn't display the **Component ID**, **Component Rev** (component revision), **Quantity**, **Yield**, **Pos** (position), **Sub Supply** (supplied by subcontractor), **Non-Owned**, and **Teardown** fields. It also doesn't display the **Dimensions**, **Ref Desigs (reference designators)**, and **Substitutes** links. Instead, it displays the **Output Item**, **Output Type**, **Output Qty** (output quantity), **Res %** (resource allocation percentage), and **Cost %** (cost allocation percentage) fields.

You may want to universally change the status of or add a new substitute item. You can search for substitutes by item or substitute. You can also search by item and substitute. To search for an item or substitute only, enter the original or substitute item in the **Component ID** field.

To search by both original and substitute, enter the original item in the **Component ID** field and click the **Substitutes** link.

Field or Control	Description
Auto Revision	<p>Select to apply, for this mass maintenance code, schemes that automatically update revisions when a change event occurs.</p> <p>You generate the automatic revisions when you run the mass maintenance functionality, either by using mass maintenance by ECO or BOM Mass Maintenance by MMC process. When selecting this check box and then specifying the MMC on the ECO and item, you indicate that a revision will be created for the ECO item. You cannot override the Rev Up check box on the ECO.</p>
Mass Maint Seq (mass maintenance sequence) and Descr (description)	<p>Enter a mass maintenance sequence number and its description. The mass maintenance sequence number enables you to set up more than one set of changes for a single MMC.</p> <hr/> <p>Note: The maximum number of sequence numbers that you can enter for an MMC is 20.</p> <hr/> <p>You can use sequence numbers to set up <i>or</i> conditions. For example, to change BOM components where the current component ID is LT5000 or LT5001, create one sequence where the component ID is LT5000 and a second sequence where the component ID is LT5001. The system applies designated changes in the sequence number order.</p> <hr/> <p>Note: Each change sequence applies to the original BOM, not to the BOM as it would look after previous sequences have been applied.</p> <hr/>

Field or Control	Description
Sequence Type	<p>Select <i>Component</i> or <i>Output</i>.</p> <p>If you select <i>Component</i>, enter the component search values. This optionally includes standard BOM fields, such as Component ID, Comp Rev (component revision), operation sequence, effective and obsolete dates, and quantity per. The system searches for values that meet all the criteria that you enter.</p> <hr/> <p>Note: The effective date and obsolete date that you enter indicate the precise date on which the component becomes effective or obsolete on the BOM.</p> <hr/> <p>If you select <i>Output</i> as your sequence type, then you can select the output item and output type. You can also enter an output quantity, resource percentage, and cost allocation percentage.</p> <p>If you don't want to change a component, then leave the Component ID field blank, and select criteria based on the other fields. If you leave any field on this page blank, the system searches for BOM components without considering the blank search field. For example, if you leave Component ID blank and enter a yield of 50, then all components with a yield of 50 are selected.</p> <p>To search for multiple components or outputs within a sequence, use the Where Search Values Area group box to enter <i>and</i> searches for more than one component or output on a BOM.</p>
Update Flag	<p>While searching for BOMs that contain multiple components or outputs, you may want to make changes only to a subset of all components or outputs. Select this check box to indicate which components or outputs that you want updated by the mass maintenance process.</p>

Related Links

[Engineering BOMs - Header: Outputs Page](#)

Assembly/Component Matches Page

Use the Assembly/Component Matches page (EN_BOM_MMC_VW_SP) to view the number of assemblies that match the search criteria that you have entered.

Also view matching BOMs.

Navigation:

Click the **Matches** link on the BOM Mass Maintenance Codes - Search page.

Field or Control	Description
Count	<p>Click this button to view the number of assemblies that match the search criteria that you have entered. The page displays engineering and manufacturing BOM totals. These values are the number of EBOMs and MBOMs that will be affected, assuming that you plan to run mass maintenance processing for all BOMs in the business unit that meet the search criteria. The actual EBOMs or MBOMs to be changed can be determined by assembly list, by range, or with assemblies associated with ECOs when the MMC is applied later.</p> <hr/> <p>Note: If you anticipate that a large number of BOMs will be affected by the search criteria, use the Count button before attempting to view BOMs, to avoid viewing too much data online.</p>
View BOMs	<p>Click this button to view engineering or manufacturing assembly matches to the criteria that you entered. This display of assembly matches lists the assemblies that can be affected by this mass maintenance sequence. When the MMC is applied later, this list of assemblies can be further restricted by supplying a range of assemblies, a specific list of assemblies, or an ECO that contains assemblies with BOM changes.</p> <p>If you selected <i>Output</i> as the sequence type on the BOM Mass Maintenance Codes - Search page, then the assembly matches display output item and output type instead of component ID.</p>

Reference Designators - Search Page

Use the Reference Designators - Search page (EN_BOM_MMC_REF_SP) to enter reference designator search criteria.

Navigation:

Click the **Ref Desigs** (reference designators) link on the BOM Mass Maintenance Codes - Search page.

For any sequence, you can search using multiple reference designators. If you enter more than one reference designator, the system searches for BOM components using a logical *and* operator between reference designators. To search references designators using an *or* operator, you must use multiple sequences.

Component Substitutes - Search Page

Use the Component Substitutes - Search page (EN_BOM_MMC_SUB_SP) to search for substitutes everywhere that they are used.

Navigation:

Click the **Substitutes** link on the BOM Mass Maintenance Codes - Search page.

You can narrow the search by using all or any combination of the substitute item search criteria.

Field or Control	Description
Sub Item (substitute item)	<p>Enter a value to search for a specific component substitute on a BOM.</p> <p>To search for a specific component substitute with a particular priority, then enter both the substitute item and the priority.</p> <p>To search for a component substitute with a particular conversion rate, then enter both the substitute item and the conversion rate.</p>
From Date and To Date	Enter values to narrow the search.

BOM Mass Maintenance Codes - Change Page

Use the BOM Mass Maintenance Codes - Change page (EN_BOM_MMC_NEW) to specify new component values, after you have selected the set of components that you want to change using the Search page.

Navigation:

Engineering > BOMs and Revisions > EBOM Mass Changes > BOM Mass Maintenance Codes > Change

This example illustrates the fields and controls on the BOM Mass Maintenance Codes - Change page. You can find definitions for the fields and controls later on this page.

The screenshot shows the 'BOM Mass Maintenance Codes - Change' page. At the top, there are three buttons: 'Search', 'Change', and 'Add'. Below these, the 'Business Unit' is set to 'US008' and there is an 'Auto Revision' checkbox. The 'Mass Maint Code' is 'NEXT' and the 'Description' field is empty. A 'Mass Maintenance Sequence' section displays 'Mass Maint Seq 10' and 'Sequence Type Component'. Below this is a 'Change Values To' section with various input fields: 'Component ID' (with a search icon), 'Comp Rev', 'Op Seq', 'Pos', 'Quantity', 'Sub Supply', 'Eff Date' (with a calendar icon and a dropdown), 'Per' (with a dropdown), 'Non-Owned', 'Obs Date' (with a calendar icon and a dropdown), 'Yield', and 'Teardown'. At the bottom of the form, there are three links: 'Dimensions', 'Ref Desigs', and 'Substitutes'.

<i>Field or Control</i>	<i>Description</i>
Component ID	<p>Enter a new value if you intend to change the component ID field.</p> <hr/> <p>Note: This is typically done for correcting BOMs. To keep history of a component change, do not enter a value here.</p> <hr/>
Output Item and Output Type	<p>If you selected <i>Output</i>, enter the required output change-to data on this page. The effectivity dates operate the same as they do for a component sequence type.</p>

Using Automatic Revisions and Effectivity Dates

<i>Field or Control</i>	<i>Description</i>
Eff Date (effective date) and Obs Date (obsolete date)	<p>These values determine the specific effectivity date changes that mass maintenance will make to the BOM for the searched components. For example, to obsolete components, leave the Eff Date field blank and specify an obsolete date, or use the second field next to the Obs Date field to derive an obsolete date for the component.</p> <p>In the second field, you can select <i>Prior Date</i> or <i>Schd Date</i> (scheduled date).</p> <p>For the obsolete date, <i>Prior Date</i> indicates the day before the scheduled date, which is the process run date. This is used, for example, to obsolete a component the day before a new component takes its place.</p> <p>If you select <i>Schd Date</i> for the effective date, then, at process time, the system translates this into the process run date. For the obsolete date, the scheduled date varies, depending on whether you selected the Auto Revision check box on the BOM Mass Maintenance Codes - Search page. If revisions aren't automatically incremented, the scheduled date is the run date of the process. If revisions are automatically incremented, the obsolete date is the obsolete date of the newly created revision. This value can be used to obsolete a component on the run date when no component is to take its place.</p>
Auto Revision	<p>If this check box is selected, and you specify the scheduled date for both the effective date and the obsolete date, the system displays a warning that the component is effective for only one day.</p>

Note: You can enter only one effective date or obsolete date. Therefore, if you specify a calendar date and then select *Schd Date*, the system clears the calendar date. Similarly, if you select a scheduled date and then enter a calendar date, the system clears the scheduled date.

This table outlines the automatic revision impact that the second set of effective date and obsolete date values have, both on revisions and the dates reflected on the BOMs. This example applies only to items that have been defined as revisions controlled on the Define Business Unit Item - Manufacturing: General page.

Also provided is an example of how the dates change on the BOM if the scheduled date is 06/15/02 on the ECO and the newly created revision is the latest revision for the item.

Change Obsolete Date to	None	Scheduled Date	Prior Date
When Effective Date equals <i>None</i>	<p>Creates new automatic revision.</p> <p>There is no BOM component effectivity date mass change.</p> <p>Example: Both the effective date and obsolete date are unchanged.</p>	<p>Creates new automatic revision.</p> <p>The system changes the obsolete date on the selected BOMs to the obsolete date of the new automatic revision.</p> <p>Example: The effective date is unchanged; the obsolete date is 12/31/2099 (the obsolete date of the new revision is added on 6/15/02).</p>	<p>Creates new automatic revision.</p> <p>The system changes the obsolete date on the selected BOMs to the obsolete date of the revision just prior to the newly added automatic revision.</p> <p>Example: The effective date is unchanged; the obsolete date is 06/14/02 (one day before the new revision is active).</p>
When Effective Date equals <i>Schd Date</i>	<p>Creates new automatic revision.</p> <p>The system changes the BOM effective date to the scheduled date of the ECO, if the mass maintenance process is run by ECO, or to the run date, if the process is run by MMC.</p> <p>Example: The effective date is 06/15/00; (the start date of the new revision), and the obsolete date is unchanged.</p>	<p>Creates new automatic revision.</p> <p>The system changes the BOM effective date to the scheduled date of the ECO, if the mass maintenance process is run by ECO, or to the run date, if the process is run by MMC.</p> <p>The system changes the obsolete date on the selected BOMs to the obsolete date of the new revision.</p> <p>Example: The effective date is 06/15/02 (start date of the new revision); the obsolete date is 12/31/2099.</p>	<p>This combination isn't allowed, because it would cause the effective date of the component to be after the due date. You must select another combination.</p>

As you can see from the previous table, with the exception of the *Schd Date* and *Prior Date* combination, all scenarios are valid and lead to the automatic generation of revisions for revision control/automatic revision items.

This table shows items that have not been defined as using automatic revisions:

Change Obsolete Date to	None	Scheduled Date	Prior Date
When Effective Date equals <i>None</i>	There is no BOM component effectivity date mass change. Example: Both the effective date and obsolete date are unchanged.	The system changes the obsolete date on the selected BOMs to the scheduled date of the ECO, if the mass maintenance process is run by ECO, or to the run date, if the process is run by MMC. Example: The effective date is unchanged; the obsolete date is 06/15/02.	The system changes the obsolete date on the selected BOMs to the date prior to the scheduled date of the ECO, if the mass maintenance process is run by ECO, or to the date prior to the run date, if the process is run by MMC. Example: The effective date is unchanged; the obsolete date is 06/14/02.
When Effective Date equals <i>Schd Date</i>	The system changes the BOM effective date to the scheduled date of the ECO, if the mass maintenance process is run by ECO, or to the run date, if the process is run by MMC. Example: The effective date is 06/15/02; the obsolete date is unchanged.	The system changes the BOM effective date and the obsolete date to the scheduled date of the ECO, if the mass maintenance process is run by ECO, or to the run date, if the process is run by MMC. Example: The effective date is 06/15/02; the obsolete date is 06/15/02.	This combination isn't allowed. You must select another combination.

Note: Automatic revision is operative only for items that are defined as using automatic revisions on the Define Business Unit Item - Manufacturing: General page. The system uses the ECO schedule date to create revisions when mass maintenance is used in conjunction with an ECO. It uses the run date of the mass maintenance process to create revisions when mass maintenance is run by MMC as a standalone.

Related Links

"Maintaining BOMs by Revisions or Effectivity Dates" (PeopleSoft Manufacturing)

Component Dimensions - Change Page

Use the Component Dimensions - Change page (EN_BOM_MMC_DIM2_SP) to make mass changes to component dimensions.

Navigation:

Click the **Dimensions** link on the BOM Mass Maintenance Codes - Change page.

Enter the existing dimension on the Component Dimensions - Search page (optional), and then enter a new value on the Component Dimensions - Change page. Entering the existing dimension on the Component Dimensions - Search page is necessary only when it must be part of the search criteria. For example, to change the weight for all occurrences of component LT5000 to 10, then enter *10* on the Component Dimensions - Change page. If this value should be changed only where its current weight is 9, then enter *9* on the Component Dimensions - Search page and *10* on the Component Dimensions - Change page.

Reference Designators - Change Page

Use the Reference Designators - Change page (EN_BOM_MMC_REF2_SP) to make mass changes to reference designators.

Navigation:

Click the **Ref Desigs** (reference designators) link on the BOM Mass Maintenance Codes - Change page.

To add, change, or delete reference designators, specify the reference designators on the Reference Designators - Search page. Only the designators must be part of the search criteria.

Otherwise, use the Reference Designators - Change page to specify an action of *Add*, *Change*, or *Delete*. When adding, specify only the new reference designator. When deleting, specify only the reference designator to be deleted. When changing, specify the current and new reference designators.

Component Substitutes - Change Page

Use the Component Substitutes - Change page (EN_BOM_MMC_SUB2_SP) to change a substitute everywhere that it is used.

Navigation:

Click the **Substitutes** link on the BOM Mass Maintenance Codes - Change page.

This example illustrates the fields and controls on the Component Substitutes - Change page. You can find definitions for the fields and controls later on this page.

Component Substitutes - Change

Change Substitutes

Unit US008 Mass Maint Code NEXT Mass Maint Seq 10

Substitute Items Find | View All First 1 of 1 Last

*Action + -

Current Values

Substitute Item ID

Priority Conversion Rate

From Date To Date

New Values

New Substitute Item

New Priority New Rate

New From Date New To Date

Field or Control	Description
Action	<p>Select a value:</p> <ul style="list-style-type: none"> • <i>Add</i> • <i>Change</i> • <i>Delete</i> <p>You can add, change, and delete component substitutes in much the same manner as you add, change, and delete reference designators. However, you have more information to maintain.</p> <p>If adding a new substitute, specify all the required new values. If deleting a substitute, specify as many of the current values as necessary to process the deletion. If changing substitute information, enter the current and new values.</p> <p>For example, to delete all occurrences of LT5001 as a substitute, enter only <i>LT5001</i> as the substitute item. To delete only the substitute LT5001 if it has priority 1, then enter <i>LT5001</i> as the substitute item and <i>1</i> as the priority.</p>

Current Values

Field or Control	Description
Substitute Item ID	Displays the current default value that comes from the business unit.
Priority, Conversion Rate, From Date, and To Date	<p>If deleting a substitute, specify as many of the current values to process the deletion.</p> <p>For example, if you want to delete all occurrences of LT5001 as a substitute, then enter only LT5001 as the substitute item ID.</p> <p>If you want to delete the substitute LT5001 only if it has priority 1, then enter <i>LT5001</i> as the substitute Item ID and <i>1</i> as the priority.</p> <p>If changing substitute information, enter the current values.</p>

New Values

Field or Control	Description
New Substitute Item	<p>Enter the value for the new substitute component.</p> <p>If you're adding a new substitute, specify all of the required new values.</p>
New Priority, New From Date, New To Date, and New Rate	<p>To change the parameters of the new substitute item, enter values where applicable. Otherwise, any values that you don't specify here for the new substitute item priority, effective dates, and conversion rate remain unchanged on the BOM.</p> <p>You can also change the parameters for the original item here. Enter only the information that you want to change.</p>

BOM Mass Maintenance Codes - Add Page

Use the BOM Mass Maintenance Codes - Add page (EN_BOM_MMC_ADD) to add components or outputs to assemblies.

The system adds these components or outputs to each BOM identified by the values that you entered on the Search page. Use the Process BOM Mass Maintenance pages to designate, at a later time, the assemblies to be affected by these changes.

Navigation:

Engineering > BOMs and Revisions > EBOM Mass Changes > BOM Mass Maintenance Codes > Add

This example illustrates the fields and controls on the BOM Mass Maintenance Codes - Add page. You can find definitions for the fields and controls later on this page.

Note: Automatic revision is operative only for items that are defined as using automatic revisions on the Define Business Unit Item - Manufacturing: General page. The system uses the ECO schedule date to create revisions when mass maintenance is used in conjunction with an ECO. It uses the run date of the mass maintenance process to create revisions when mass maintenance is run as a standalone.

Field or Control	Description
<p>Component ID</p>	<p>You must select a component if you selected a sequence type of <i>Component</i> on the BOM Mass Maintenance Codes - Search page.</p> <p>Enter associated values that you want to add to the selected BOMs that meet the search criteria specified on the BOM Mass Maintenance Codes - Search page.</p> <p>You can add multiple components per MMC.</p> <p>You can also add a placeholder item as a component. If the MMC is later applied to manufacturing BOMs that don't allow placeholders, then the process flags that BOM change as an exception, and the BOM won't be changed.</p>
<p>Output Item and Output Type</p>	<p>If you selected a sequence type of <i>Output</i> on the BOM Mass Maintenance - Search page, enter values and any additional required output data.</p>

Note: The values that you select on these pages are subject to the same validation checks that apply to any engineering BOM or manufacturing BOM component or output values. Some of these checks occur when you create the MMC, and the remaining validation checks occur at the time that the MMC is applied.

Component Substitutes - Add Page

Use the Component Substitutes - Add page (EN_BOM_MMC_SUB3_SP) to add a substitute everywhere that it is required.

Navigation:

Click the **Substitutes** link on the BOM Mass Maintenance Codes - Add page.

This example illustrates the fields and controls on the Component Substitutes - Add page. You can find definitions for the fields and controls later on this page.

Field or Control	Description
	Click the Copy Substitute button to display all valid substitute items for the business unit.
OK	Click this button to add all valid substitute items for the business unit.

If you don't want to add all valid substitute items for the business unit, enter each individual substitute item that you want to add, as well as the priority, from date, to date, and conversion rate for each substitute.

Note: Substitute items must be unique for the item. You cannot enter the same item twice as a substitute with different dates. For example, substitute A with effective dates from 01/01/99 to 02/01/99 and substitute A with effective dates from 02/01/00 to 08/30/00 couldn't be substitutes for the same item. In this case, define a different substitute for the second set of effective dates.

Making BOM Mass Changes and Creating Automatic Revisions

This topic provides an overview of BOM mass changes and automatic revisions.

Pages Used to Make BOM Mass Changes and Create Automatic Revisions

<i>Page Name</i>	<i>Definition Name</i>	<i>Usage</i>
Apply Mass Changes by ECO Page	EN_MASSMNT_REQ	Define the ECO options for the BOM Mass Maintenance COBOL SQL process (ENPMMAIN).
Mass Maint Code Options Page	EN_MASSMNT_REQ2	Define MMC options for the BOM Mass Maintenance COBOL SQL process.
Assembly Item Options Page	EN_MASSMNT_REQ3	Choose the items to which the BOM Mass Maintenance process will be applied.
Select Assemblies by Items Where Used Page	EG_BOM_WHEREUSE_SP	Quickly populate affected assemblies into the primary page.
Select Assemblies by Items Where Used: Enter Dimensions Page	EN_BOM_DIM_SP	Specify the dimensions of the component. Select Assemblies by Items Where Used Page
Select Assemblies by Items Where Used: Reference Designators Page	EG_BOM_WU_REF_SP	Specify the reference designator of the component. Select Assemblies by Items Where Used Page
Mass Maintenance Exceptions Page	EN_MMC_TRN_STAT	View the reasons why BOMs weren't changed by the BOM Mass Maintenance process.

Understanding BOM Mass Changes and Automatic Revisions

You can make BOM mass changes, as well as create automatic revisions, in two ways: by ECO or by MMC. While the processing in each case is similar, the way in which you determine the assemblies to change differs.

Both mass maintenance processes can generate automatic revisions.

To create automatic revisions (no BOM changes) using mass maintenance by ECO:

1. Create the ECO.

Include items (make or buy) that you want to automatically revise and select the **Auto Rev** check box.

2. Run the mass maintenance by ECO process (an MMC isn't required).

The system creates a new revision effective on the ECO schedule date.

To update BOMs and create automatic revisions using the mass maintenance by MMC process:

1. Define the MMC using the BOM Mass Maintenance component.
2. Create the ECO.

Attach the MMC to one or more items on the ECO. (If the MMC is defined with the **Auto Rev** check box selected, and the ECO item is revision-controlled and defined to allow automatic revisions, the **Auto Rev** check box on the ECO is selected and cannot be deselected.)

3. Run the mass maintenance by MMC process.

The system creates a new revision, effective on the ECO schedule date.

Note: You can also include additional items on the ECO that aren't affected by the MMC but that are to be automatically revisioned. List them and select the **Auto Rev** check box on the ECO. When the mass maintenance process by ECO runs, it creates new revisions for these items as well.

To create automatic revisions using the mass maintenance by MMC process:

1. Define the MMC using the BOM Mass Maintenance component.
2. Run the mass maintenance by MMC process.

The system creates a new revision effective on the mass maintenance by MMC process run date.

Common Elements Used in This Section

<i>Field or Control</i>	<i>Description</i>
<p>Update Options</p>	<p>Select from:</p> <ul style="list-style-type: none"> • <i>Validate and Update:</i> The process validates and updates the BOMs, depending on the update option that you select (only if all BOMs are valid or for any valid BOMs). • <i>Only if all BOMs are valid:</i> The system updates all BOMs, but only if they have no error exceptions. <p>If one BOM has an error, the system won't update any BOMs.</p> <p><i>Any valid BOMs:</i> The system updates any BOM that doesn't have errors.</p> <p>With either option, view invalid BOMs with the Engineering Mass Maintenance Exceptions page.</p> <ul style="list-style-type: none"> • <i>Validate Only:</i> The process validates BOMs, but doesn't update them. <p>The system makes the Only if all BOMs are valid and Any valid BOMs options unavailable for selection.</p> <p>Use <i>Validate Only</i> and the Mass Maintenance Exceptions page to determine whether there are any validation problems with BOMs. You can then make any necessary corrections before you actually update the BOMs.</p>
<p>Staged BOM Data Options</p>	<p>Select an option to determine what should be done with the data that was used during the Mass Maintenance process:</p> <p><i>Delete Stage Results:</i> The system doesn't save the results of the Mass Maintenance process, and you cannot use the Mass Maintenance Staged BOMs component to view the changed BOMs or correct errors.</p> <p><i>Stage Results:</i> You can use the Mass Maintenance Staged BOMs component to:</p> <ul style="list-style-type: none"> • View which BOMs were updated by the Mass Maintenance process. • Correct BOMs that returned an error status. • Resubmit the process. <p>If you stage results, select whether to run the Mass Maintenance process in report only mode. If you select this option, you can only view the results of the Mass Maintenance process using the Mass Maintenance Staged BOMs component. If you don't select this option, you can use the Mass Maintenance Staged BOMs component to view the staged BOMs, update errors, and submit corrected BOMs for reprocessing.</p>

Field or Control	Description
Engineering validation	Use the validation options to determine how the BOM should be validated. This option allows placeholders to be added to BOMs.
Manufacturing validation	This option is stricter than engineering validation, requiring that components both exist in the business unit and be approved. If you update manufacturing BOMs (by setting the BOM state to <i>Manufacturing</i>), then manufacturing validation is required. If you are updating engineering BOMs (by setting the BOM state to <i>Engineering</i>), the stricter manufacturing validation is optional.

Apply Mass Changes by ECO Page

Use the Apply Mass Changes by ECO (apply mass changes by engineering change order) page (EN_MASSMNT_REQ) to define the ECO options for the BOM Mass Maintenance COBOL SQL process (ENPMMAIN).

Navigation:

Engineering > Engineering Changes > Apply Mass Changes by ECO > Apply Mass Changes by ECO

This example illustrates the fields and controls on the Apply Mass Changes by ECO page. You can find definitions for the fields and controls later on this page.

You have two ECO options: you can enter only an ECO number range or both a number range and an ECO schedule date range.

The system uses the BOM MMCs that you specify on an ECO to make the mass changes and to create automatic revisions.

If the MMC on the ECO has been set to include automatic revisions, then the system also automatically creates revisions. Revisions are effective as of the ECO schedule date.

Note: Only items that have been defined as revision-controlled with automatic revisions (on the Define Business Unit Item - Manufacturing: General page) and that are also set up to use automatic revisions (on the BOM Mass Maintenance - Search page) are automatically incremented.

The system also uses the BOM code and BOM type that you specified on the ECO Maintenance - Items Affected page to determine the BOMs to change. If you left the **BOM Code** field blank, the MMC applies to all BOM codes. There can be one MMC for all BOM changes on an ECO, or there can be a different MMC for each BOM change on the ECO.

Note: When running the BOM Mass Maintenance process to create new revisions only, you must run the process with the update option of *Validate and Update* to create new revision numbers. *Validate*, in this context, means that all BOMs are valid for update (including no duplicate components and overlapping effectivity dates); it doesn't mean that the system checks for loops. To check for looping BOMs, you must run the BOM verification process after you have run the BOM Mass Maintenance process.

Field or Control	Description
Error if BOM does not exist	If you select this check box, and the ECO includes assemblies for which no BOM exists, an error is generated.

For any manufacturing BOM or engineering BOM that is updated by the BOM Mass Maintenance process, the **ECO Number** field on the BOM and engineering BOM maintenance component details pages is updated with the ECO number used in this process. The ECO number shown on the component details is the last ECO number that updated the component on the assembly. The **ECO** button on the same page reflects any pending ECOs.

This process also updates the MMC status on the ECO Mass Maintenance page. For BOMs with errors, the system sets the status to *Error*. For BOMs that were updated, the status is set to *Success*. Finally, for BOMs that weren't affected by the MMC (that is, they didn't meet the search criteria), the system sets the status to *No Affect*.

If you resubmit this process against the same ECOs, the system processes only the BOMs whose mass maintenance status is either *Pending*, *Error*, or *No Affect*.

Any ECO items that were both successfully changed and were flagged with only a BOM change (no routing change) on the ECO Header or Items Affected page are released. If all items on the ECO are released, then the ECO itself is also released.

Related Links

"Maintaining BOMs by Revisions or Effectivity Dates" (PeopleSoft Manufacturing)

Mass Maint Code Options Page

Use the Mass Maint Code Options (mass maintenance code options) page (EN_MASSMNT_REQ2) to define MMC options for the BOM Mass Maintenance COBOL SQL process.

Navigation:

Engineering > BOMs and Revisions > EBOM Mass Changes > Apply EBOM Mass Changes by MMC > Mass Maint Code Options

This example illustrates the fields and controls on the Mass Maint Code Options page. You can find definitions for the fields and controls later on this page.

Field or Control	Description
<p>Unit and Mass Maintenance Code</p>	<p>Enter values to apply to a range or list of assemblies.</p> <p>If the MMC has been set to include automatic revisions, the system also automatically creates revisions. Revisions are effective as of the run date of this process.</p> <hr/> <p>Note: Only items that have been defined as revision-controlled with automatic revisions and also set up to use automatic revisions (with the BOM Mass Maintenance - Search page) are incremented.</p>

Field or Control	Description
Auto Revision Effective Date	<p>Enter the effective date to be used by all new auto-revisions that are created in this process run. If this field is left blank, then today's date is used as the new revision effective date. Keep in mind that all revisions within one process run will use the same date.</p> <p>If the date entered in this field provides a date that is earlier than an existing revision, then the revision will be given an obsolete date. Obsolete dates are based on the effectivity of the next revision. However, the most effective way to tie component obsolescence and new component effectivity to auto-revisions is to take advantage of the <i>Schedule Date</i> or <i>Prior Date</i> options offered on the BOM Mass Maintenance Codes - Change page or the BOM Mass Maintenance Codes - Add page. This will eliminate possible errors caused by user-entered dates that do not correspond with the effective date selected for the new revisions.</p>

Related Links

[Apply Mass Changes by ECO Page](#)

Assembly Item Options Page

Use the Assembly Item Options page (EN_MASSMNT_REQ3) to choose the items to which the BOM Mass Maintenance process will be applied.

Navigation:

Engineering > BOMs and Revisions > EBOM Mass Changes > Apply EBOM Mass Changes by MMC > Assembly Item Options

Field or Control	Description
Item Options	<p>Select one of these options:</p> <ul style="list-style-type: none"> • Range: Also select the BOM type and BOM code. • List of Assembly Items
	<p>Click the Search button to populate the List of Assembly Items field.</p>
Run	<p>Click to run this request. PeopleSoft Process Scheduler runs the ENPMMAIN process at user-defined intervals.</p>

Select Assemblies by Items Where Used Page

Use the Select Assemblies by Items Where Used page (EG_BOM_WHEREUSE_SP) to quickly populate affected assemblies into the primary page.

Navigation:

- Click the **Where Used** link on the Assembly Item Options page.
- **Engineering > Engineering Changes > Maintain ECRs > Header > Header**
Click the **Where Used** link.
- **Engineering > Engineering Changes > Maintain ECOs > Header > Header**
Click the **Where Used** link.
- **Engineering > Engineering Changes > Engineering Transfers > Assembly Selection**
Click the **Where Used** link.

This example illustrates the fields and controls on the Select Assemblies by Items Where Used page. You can find definitions for the fields and controls later on this page.

Field or Control	Description
Search	If you select <i>Components Only</i> , the system displays basic component information. If you select <i>Outputs Only</i> , the system displays basic output information, including output type, BOM code, output quantity, and effectivity dates.
Sel (select)	Select the check box for all the outputs to transfer to the main page.
Search	Click this button to populate the page.
View	Select either <i>Indented</i> or <i>No-Indent</i> .

Field or Control	Description
Comp Rev (component revision)	<p>This field appears if the component is revision-controlled. If you enter a component revision, the Select Assemblies by Items Where Used page returns all assemblies where that component is an exact match or where the current revision is used.</p> <p>If you leave the field blank, the system returns assemblies that use any revision of the component.</p>

ECO or ECR Maintenance Pages

If you have accessed this page from either the ECO or ECR maintenance pages, you can:

- Change the BOM state to either *Engineering* or *Manufacturing*.
- Select default ECO values.

These values include the ECO item type and whether the item requires a BOM change (**BOM** check box) or routing change (**Rtg** check box). When accessed from ECO maintenance pages, there is an additional default value called **Rev Up**. This check box is available only if you have selected a type of *IMP* and if you have selected the **BOM** check box.

Note: These are only default value; therefore, when the selected items are returned to the ECO, the **Rev Up** check box is selected only for the items that are auto-revision controlled.

Engineering Transfer or Process BOM Mass Maintenance by MMC Pages

If you have accessed this page from either the Engineering Transfer or Process BOM Mass Maintenance by MMC pages, then BOM state is unavailable for selection. BOM state reflects the selection that you made in the **From/To** field on the Transfer Selection page or the on the BOM Mass Maintenance Codes pages.

Field or Control	Description
Search	<p>Values are:</p> <ul style="list-style-type: none"> • <i>Components Only</i>: The system displays basic component information, and all higher-level subassemblies or assemblies that contain the selected item. • <i>Components and Substitutes</i>: The system displays all higher-level subassemblies or assemblies that contain the selected item, including substitutes. • <i>Outputs Only</i>: The system displays basic output information, including output type, BOM code, output quantity, and effectivity dates. • <i>Substitutes Only</i>: The system displays substitutes for the selected item.
Sel (select)	<p>If you selected <i>Outputs Only</i> in the Search field, select this check box for all components to transfer to the main page.</p> <p>If the component is revision-controlled, the Comp Rev field appears, and you can use it as part of the search. If you enter a component revision, the Select Assemblies by Items Where Used page returns all assemblies where that component is an exact match or where the current revision is used.</p> <p>If you leave revision blank on a revision-controlled component, this page returns assemblies that use any revision of the component</p> <p><i>Outputs Only</i>: If you select this option, the system will display basic output information, including output type, BOM code, output quantity, and effectivity dates. You can then select the Sel check box for all the outputs that you want to have transferred to the main page. Then click OK.</p>

Related Links

[Maintain ECOs - Header: Header Page](#)

Mass Maintenance Exceptions Page

Use the Mass Maintenance Exceptions page (EN_MMC_TRN_STAT) to view the reasons why BOMs weren't changed by the BOM Mass Maintenance process.

Navigation:

Engineering > BOMs and Revisions > EBOM Mass Changes > Mass Maintenance Exceptions > Mass Maintenance Exceptions

This example illustrates the fields and controls on the Mass Maintenance Exceptions page. You can find definitions for the fields and controls later on this page.

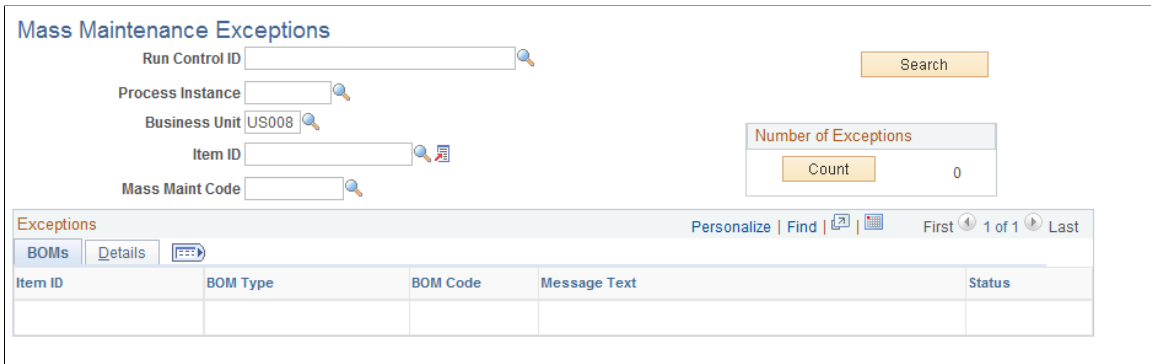

Click the **Count** button to view the number of errors.

After you have reviewed the exceptions and made any needed changes to the BOMs or mass maintenance data, you can rerun the mass maintenance process.

If you ran mass maintenance in update mode by ECO, any ECO items that had errors are noted on the Maintain ECO Mass Maintenance page for each ECO BOM that had an error. If you rerun the mass maintenance process by ECO, the mass maintenance process attempts to apply changes to only those BOMs in error, as well as to any BOMs with a status of *No Affect* or any new BOMs added to the ECO with a mass maintenance status of *Pending*.

You can view the reasons why BOMs (displayed by item ID, BOM type, and BOM code) weren't changed by the BOM Mass Maintenance process.

Validation Checks

All requested changes made with either of the Process EBOM Mass Maintenance pages are validated before any engineering or manufacturing BOM changes are made. The system checks the interaction of all components and outputs on the product structure: these same checks are made within the BOM maintenance pages.

See the troubleshooting documentation on the My Oracle Support website.

Viewing and Correcting BOM Messages Using Staged BOMs

As part of the mass maintenance process, you can correct BOM messages with data errors using the Staged BOMs pages. You can view each BOM message and correct the errors using these pages. You can then change the status to *Reprocess* and submit the BOM for reprocessing immediately, or use the MMC Staged BOM process to reprocess a range of BOMs.

This topic discusses how to view and correct BOM messages using staged BOMs.

Pages Used to View and Correct BOM Messages Using Staged BOMs

Page Name	Definition Name	Usage
Update Staged EBOM Details - BOM Status Page	EN_TRN_BOM_STAT	View, and possibly update, the results from a BOM Mass Maintenance process. You must have run the BOM Mass Maintenance process with the staged BOM data option of <i>Stage Result</i> .
Update Staged EBOM Details - Summary Page	EN_TRN_BOM_HDR	View and update the results from a BOM Mass Maintenance process.
Update Staged EBOM Details - Header: Assembly Text	EN_TRN_BOM_TEXT	View and update the results from a BOM Mass Maintenance process.
Update Staged EBOM Details - Header: Outputs Page	EN_TRN_BOM_OUT	View and update the results from a BOM Mass Maintenance process.
Update Staged EBOM Details - Components: Component Details	EN_TRN_BOM_CMP	View and update the results from a BOM Mass Maintenance process.
Update Staged EBOM Details - Components: Reference Designators	EN_TRN_BOM_CMPDESG	View and update the results from a BOM Mass Maintenance process.
Update Staged EBOM Details - Components: Dimensions	EN_TRN_BOM_CMPDIM	View and update the results from a BOM Mass Maintenance process.
Update Staged EBOM Details - Components: Substitutes	EN_TRN_BOM_SUB	View and update the results from a BOM Mass Maintenance process.

Update Staged EBOM Details - BOM Status Page

Use the Update Staged EBOM Details - BOM Status page (EN_TRN_BOM_STAT) to view, and possibly update, the results from a BOM Mass Maintenance process.

Navigation:

Engineering > BOMs and Revisions > EBOM Mass Changes > Update Staged EBOM Details > BOM Status

BOMs tab

Field or Control	Description
BOM State	Displays <i>Manufacturing</i> or <i>Engineering</i> . The BOM state must be valid, or the system considers the message an error.

Field or Control	Description
BOM Code	Assign a primary and up to 98 alternate BOMs. There must be a BOM code, or the system considers the message an error.
Status	<p>Indicates the eligibility of this BOM for further processing. You can receive BOM error messages with any of these statuses:</p> <ul style="list-style-type: none"> • <i>Complete</i>: You cannot update the staged results for this BOM because the BOM has already been updated in the system. You can only view the BOM. • <i>Error</i>: There is at least one data validation error in the staged results for this BOM. You can change the status to <i>Cancelled</i> or <i>Reprocess</i>. • <i>In Process</i>: Processing of a transaction has been initiated. • <i>Incomplete</i>: The transaction is still being created by the transaction pages. The status changes to <i>New</i> when the transaction is ready to be processed by the background processes. The system won't process an incomplete transaction. • <i>New</i>: The staged results are valid, but the original BOM hasn't been updated yet. The BOM is eligible for update and reprocessing. You can change the status to <i>Cancelled</i> or <i>Reprocess</i>. • <i>Reprocess</i>: When you correct errors using the Transaction Maintenance Detail pages, change the BOM status to <i>Reprocess</i>.
BOM Type	Indicates whether you have received a <i>Production</i> or <i>Rework</i> BOM. Production BOMs are used as the basis for manufacturing assemblies. Rework BOMs are used when you have a standard rework process where you include additional components to repair BOMs. The BOM type must be valid, or the system considers the message an error.

If you are correcting multiple messages, you can manually change the status of each message to *Reprocess* after you've corrected the data. Then run the BOM Loader process to reprocess the data for multiple messages. The system changes *Reprocess* and *New* messages to the *Complete* status after confirming that there are no errors in the message.

To correct a single message, select the **Reprocess** check box to set the message status to *Reprocess*, and click **OK** or **Apply** to initiate the validation background process.

Messages

In the **Messages** scroll area, the system displays the error message, the result of the message, and the BOM details for the message.

This page lists of all the errors and warnings for the BOM, whether for the overall BOM, a specific component, or output. The **Result** column indicates the severity of the message. *W* indicates a warning and doesn't stop the BOM from being valid. *E* indicates an error and must be fixed for the BOM to be valid.

Update Staged EBOM Details - Summary Page

Use the Update Staged EBOM Details - Summary page (EN_TRN_BOM_HDR) to view and update the results from a BOM Mass Maintenance process.

Navigation:

Engineering > BOMs and Revisions > EBOM Mass Changes > Update Staged EBOM Details > Summary

<i>Field or Control</i>	<i>Description</i>
Component ID , Comp Rev (component revision), Op Seq (operation sequence), Eff Date (effective date), Obs Date (obsolete date), Quantity , and Per	You can change values for these fields.

Related Links

"Manufacturing BOMs - Summary Page" (PeopleSoft Manufacturing)

Update Staged EBOM Details - Header: Outputs Page

Use the Update Staged EBOM Details - Header: Outputs page (EN_TRN_BOM_OUT) to view and update the results from a BOM Mass Maintenance process.

Navigation:

Engineering > BOMs and Revisions > EBOM Mass Changes > Update Staged EBOM Details > Header > Outputs

For each output, you can change the output type, output item, source code, resource allocation percentage, and cost allocation percentage.

Related Links

"Header: Outputs Page" (PeopleSoft Manufacturing)

Processing Staged EBOMs

After you've viewed and corrected staged BOMs, run the MMC Stage Application Engine process (EN_BOM_MSG) to reprocess the BOMs.

Page Used to Process Staged EBOMs

<i>Page Name</i>	<i>Definition Name</i>	<i>Usage</i>
Process Staged EBOMs Page	EN_RUN_BOMSTAGE	Reprocess corrected staged BOMs using the MMC Stage process.

Process Staged EBOMs Page

Use the Process Staged EBOMs page (EN_RUN_BOMSTAGE) to reprocess corrected staged BOMs using the MMC Stage process.

Navigation:

Engineering > BOMs and Revisions > EBOM Mass Changes > Process Staged EBOMs > Process Staged EBOMs

This example illustrates the fields and controls on the Process Staged EBOMs page. You can find definitions for the fields and controls later on this page.

Process Staged EBOMs

Run Control ID RUN01 Report Manager Process Monitor Run

Stage Process Parameters

Business Unit

Process Instance

Update Options

Re-process any Errors Purge Stage and Error Records

Field or Control	Description
Update Options	Select from: <ul style="list-style-type: none"> • <i>Validate Only</i>: Validates the data but doesn't load or change BOM tables. • <i>Validate and Transfer</i>: Validates the data and loads and changes BOM tables.
Re-process any Errors	<p>If you are processing a large number of BOMs, you can correct the errors in the BOM pages but leave the status as <i>Error</i>. You can then select this check box while running the MMC Stage process, and the system reprocesses transactions with the statuses of <i>New</i>, <i>Reprocess</i>, and <i>Error</i>.</p> <p>If this check box is deselected, then only transactions with statuses of <i>New</i> and <i>Reprocess</i> are processed. This option is only applicable when <i>Validate Only</i> or <i>Validate and Transfer</i> is selected.</p>
Purge Stage and Error Records	<p>Select this check box to delete the error transactions from the staging table once you have run this process.</p> <p>If you select <i>Validate and Transfer</i> and you select the Purge Stage and Error Records check box here, then the BOMs are first validated and then transferred to the BOM tables. If any BOMs are invalid, the BOM tables won't be updated, but the BOMs are still deleted from the Stage and Error records.</p> <p>If you select <i>None</i> and you select the Purge Stage and Error Records check box here, then the BOMs won't be validated or changed. The Stage and Error records are purged. This combination can be used to clean up after you have completed processing BOMs.</p>
Run	Click to run this request. PeopleSoft Process Scheduler runs the MMC Stage process at user-defined intervals.

Chapter 6

Displaying Engineering Bills of Material

Displaying Engineering BOM Structures

Pages Used to Display Engineering BOM Structures

<i>Page Name</i>	<i>Definition Name</i>	<i>Usage</i>
Review EBOM Information - Summary Page	EN_BOM_INQUIRY	Use the Review EBOM Information - Summary page to view EBOM component structure at a summary level, including the indented EBOM structure.
Review EBOM Information - Component Substitutes page	EN_BOM_INQ_SUB	Use the Review EBOM Information - Component Substitutes page to display EBOM component substitute items.
Engineering BOM inquiry - Header: Outputs Page	EN_BOM_INQ_OUTS	Use the Engineering BOM inquiry - Header: Outputs page to display EBOM outputs.
Engineering BOM inquiry - Comp Detail: Component Details Page	EN_BOM_INQUIRY_D	Use the Engineering BOM inquiry - Comp Detail: Component Details page to display EBOM component details such as effectivity date or revision, quantity, yield, and unit of measure.

Related Links

[Understanding PeopleSoft Engineering Bills of Material](#)

Common Elements Used in This Section

<i>Field or Control</i>	<i>Description</i>
BOM State	Displays <i>Engineering</i> by default. You can also view manufacturing BOMs by selecting <i>Manufacturing</i> on the selection criteria page.

Field or Control	Description
BOM Type	<p>Select a BOM type. Values are:</p> <ul style="list-style-type: none"> <i>Production</i>: This is the default EBOM type. Manufacturing production BOMs can be used for standard manufacturing processes. <i>Rework</i>: Create rework EBOMs when you have a standard kit of components used in rework or repair.
View	<p>View summary data with these options:</p> <ul style="list-style-type: none"> <i>Indented with Dates</i> <i>Indented with Revs</i> (indented with revisions) <i>Non-Indented with Dates</i> <i>Non-Indented with Revs</i> <p>The indented options provide an indented (tree) EBOM structure for the selected depth.</p>
All Dates/Revs	Select this check box to search all effective dates and revisions for the item's EBOM.
Eff Date (effective date) and Obs Date (obsolete date)	Displays the beginning and ending dates for the EBOM.

Review EBOM Information - Summary Page

Use the Review EBOM Information - Summary page (EN_BOM_INQUIRY) to view EBOM component structure at a summary level, including the indented EBOM structure.

Navigation:

Engineering >BOMs and Revisions >Review EBOM Information >Engineering BOMs >Summary

This example illustrates the fields and controls on the Review EBOM Information - Summary page: Summary tab. You can find definitions for the fields and controls later on this page.

Field or Control	Description
Unit, Item ID, BOM Type, BOM Code, Eff Date (effective date), and Revision	Enter the basic information about the BOMs.
Depth	Indicate the number of levels that you want to view by specifying the depth to be displayed. If you select a depth of 1, this page displays only the top level of the EBOM.

Note: You can select any valid BOM code. However, the system always calculates lower levels based on the primary BOM code 1, regardless of the depth that you enter.

After you make your selections, click the **Search** button to view the data. The system sorts the summary in this sequence:

1. Assembly
2. Subassembly
3. Component
4. Operation sequence
5. Effective date

Note: If a component revision is specified during BOM maintenance, the component revision appears on this tab. If the component is revision-controlled but the field is left blank because this is the current revision, this inquiry displays the current revision code for the component, based on the top-level effective date or revision entered.

Click a component ID to access component details.

Attributes tab

<i>Field or Control</i>	<i>Description</i>
Outputs	Click this link to view the outputs for lower-level items (if it is a multiple output BOM).
Substitutes	Click this link to view substitute data, if substitutes exist.

Related Links

[Engineering BOMs - Header: Outputs Page](#)

[Engineering BOMs - Components: Substitutes Page](#)

Review EBOM Information - Component Substitutes page

Use the Review EBOM Information - Component Substitutes page (EN_BOM_INQ_SUB) to display EBOM component substitute items.

Navigation:

Engineering >BOMs and Revisions >Review EBOM Information >Engineering BOMs >Summary

Click the **Substitutes** link on the Attributes tab.

This example illustrates the fields and controls on the Review EBOM Information - Component Substitutes page. You can find definitions for the fields and controls later on this page.

Component Substitutes						
Item	SR2001	Gear Subassembly	Std UOM	EA		
Component ID	GR8000	Gear, Sugishita	Std UOM	EA	Pos Nbr	0
Op Seq	50	Eff Date	01/01/1985	Obs Date	12/31/2099	
Eff Rev	A	Obs Rev	---			
Substitute Items						
Personalize Find View All First 1 of 1 Last						
Priority	Substitute Item ID	Description	From Date	To Date	Conversion Rate	Std UOM
1	GR8001	Gear, Campani	01/01/2000	12/31/2099	1.00000000	EA

Substitutes and related data such as conversion rate and effectivity dates appear in order of priority.

Engineering BOM inquiry - Header: Outputs Page

Use the Engineering BOM inquiry - Header: Outputs page (EN_BOM_INQ_OUTS) to display EBOM outputs.

Navigation:

Displaying Summarized Engineering BOMs

This topic discusses how to display summarized engineering BOMs.

Pages Used to Display Summarized Engineering BOMs

<i>Page Name</i>	<i>Definition Name</i>	<i>Usage</i>
<u>EBOM Summarized Page</u>	EN_BOM_SUMMARY	View, at all levels, all the components that comprise an assembly's product structure. This page specifically enables you to view the quantity of components needed in an assembly regardless of level. You can also use it to determine component requirements, at all levels, based on a specific assembly demand quantity.
<u>EBOM Summarized Outputs Page</u>	EN_BOM_SUMM_OUTS	View output items by output type.

EBOM Summarized Page

Use the EBOM Summarized page (EN_BOM_SUMMARY) to view, at all levels, all the components that comprise an assembly's product structure.

This page specifically enables you to view the quantity of components needed in an assembly regardless of level. You can also use it to determine component requirements, at all levels, based on a specific assembly demand quantity.

Navigation:

Engineering > BOMs and Revisions > Review EBOM Information > EBOM Summarized > EBOM Summarized

This example illustrates the fields and controls on the EBOM Summarized page. You can find definitions for the fields and controls later on this page.

The screenshot shows the 'EBOM Summarized' interface. At the top, there are search filters: *Unit (US008), *Item ID (SR2001), *BOM Type (Production), Revision (A), Eff Date (06/26/2014), Required Qty (1.0000), Gear Subassembly (*BOM Code 1), Std UOM (EA), Depth (1), Assembly Starts Qty (1.0000), Source Code (Make), BOM Qty (1), and Routing Code. A 'Search' button is located to the right of the filters. Below the filters, there are tabs for 'Summary' and 'Detail', and a 'View' dropdown set to 'Indented'. A 'Chunk Size' of 100 is also visible. The main area contains a table titled 'Components' with columns: Lvl, Component ID, Description, Op Seq, Quantity, Std UOM, Per, Qty Required, and Qty Available. The table lists 10 components, including Gear, Chain, Derailleurs, Cassette, Axle Carrier, Cable Housing, Dust Cover, Crank Set Subassembly, and Hub Subassembly.

Field or Control	Description
Unit, Item ID, BOM Type, BOM Code, Eff Date, and Revision	Select information to specify the BOM that you want to display.
Search	Click to display the summarized BOM.
Required Qty (required quantity)	<p>To determine the total number of each component required at all levels to produce a particular quantity of the assembly item, enter the required quantity for the assembly item. The system multiplies each component's quantity per assembly by this required quantity to determine the component required quantity displayed on the lower half of the page.</p> <p>Click the Search button again to display the calculated required quantities.</p> <p>To view a summarized BOM, enter a required quantity of 1.</p>
Depth	<p>Enter the BOM depth. If you select a depth of 1, this page displays only the top level of the BOM.</p> <hr/> <p>Note: You can select any valid BOM code, but regardless of the depth that you enter, the system calculates all lower levels based on the primary BOM code (1).</p> <hr/>
Routing Code	Select the appropriate routing for the item.
Assembly Starts Qty	Displays the beginning quantity required based on the required quantity. This amount accounts for any operation yield loss during the production process.

Field or Control	Description
Summary	This button lists only the component ID, description, and quantity required, and summarizes the total required quantity for the component across all levels. The quantity required accounts for both component yield and operation yield. The current quantity available from business items attributes also appears.
Detail	This button provides data for all fields and enables the View field. You can view summary data either <i>Indented</i> or <i>Non-Indented</i> . The indented option provides an indented (tree) BOM structure for the selected depth. You can toggle back and forth between summary and detail information.

The system sorts the summary alphanumerically by component ID for level 1 items and summarizes the displayed data by quantity, regardless of where the component occurs in the product structure.

When substitute items or multiple outputs exist for a component, those links appear following the **Qty Available** field.

Related Links

[Engineering BOMs - Header: Outputs Page](#)

[Engineering BOMs - Components: Substitutes Page](#)

EBOM Summarized Outputs Page

Use the EBOM Summarized Outputs page (EN_BOM_SUMM_OUTS) to view output items by output type.

Navigation:

Engineering > BOMs and Revisions > Review EBOM Information > EBOM Summarized > EBOM Summarized Outputs

Note: The system explodes only primary co-products for the BOM code specified. Only outputs at the top level appear, regardless of the depth entered.

Field or Control	Description
Expected Output Qty	Represents the anticipated output of each primary, co-product, recycle, and waste product, based on the required quantity that you enter. This is calculated as: $((\text{Required Qty} / \text{BOM Qty}) * \text{Output Quantity})$

Displaying Engineering BOM Costs

This topic provides an overview of engineering BOM costs and discusses how to display engineering BOM costs.

Pages Used to Display Engineering BOM Costs

<i>Page Name</i>	<i>Definition Name</i>	<i>Usage</i>
Costed EBOMs Page	EN_BOM_INQ_COSTED	Display EBOM summary costs.
Output Costs Page	EN_BOMCOST_OUT_SP	Display, by output type, all lower-level costing details for each co-product based on the costing percentage split.
Detailed Costs Page	EN_ITEMCOST_OUT_SP	Display This Level Costs and Lower Level Costs by cost element for the selected item ID and output type. Output Costs Page
Component Detail Costs Page	EN_ITEMCOST_SP	Display EBOM component details. With this page, you can display the Extended This Level Cost and Extended Lower Level Costs by cost element for the selected component item, cost type, and cost version.
EBOM Costed Report	EN_BOM_COST_REPORT	Generate a hard copy report (ENS1010) that lists in detail associated engineering BOM costs.

Understanding Engineering BOM Costs

To determine the costing impact of EBOM changes to an assembly, you can display the costs of an assembly, its components, and outputs by cost type and cost version. This is especially useful for determining the costing impact of engineering BOM changes on an assembly.

The Costed EBOMs component performs a mini cost roll-up on the assembly that you enter. It calculates the assembly's cost (including all outputs) by summarizing the cost of the components and outputs based on the BOM in effect on the date specified or for the revision specified. Routing costs are not recalculated.

Here is how the system performs the cost roll-up:

- It looks at the components and outputs in effect for the selected BOM code, based on the as of date, and it uses BOM code *I* for all lower levels.

- To value the components, it uses the existing costs associated with the item for the cost type and cost version selected.

This includes any This Level and Lower Level labor, machine, subcontracting, and overhead costs for the component (when the component is a subassembly).

- It includes the routing cost by using the existing This Level labor, machine, subcontracting, and overhead costs for the cost type and cost version based on the cost roll-up performed.

Note: Expensed and planning items are not included in the cost roll-up. No costs are required for expensed or planning items because no quantity on hand is maintained in inventory.

You maintain cost types and versions within PeopleSoft Cost Management. Cost types enable you to do costing simulations and what-if analyses and to calculate new standard costs prior to updating your production costs. Cost versions are iterations of a particular cost calculation for a cost type. You can have multiple versions of costs for each cost type. Cost roll-ups for production items are calculated by cost type and cost version. Within PeopleSoft Engineering, you specify engineering cost versions for the cost types defined in PeopleSoft Cost Management. This enables you to perform cost roll-ups on the EBOM. You can't display costed EBOM information for rework EBOMs.

Once you've performed the engineering BOM cost roll-up using the selected cost type and engineering cost version, BOM code, and routing code, you can use this inquiry to determine what impact subsequent changes to the BOM have on the item's cost.

Related Links

"Understanding Production Costs" (PeopleSoft Cost Management)

Costed EBOMs Page

Use the Costed EBOMs page (EN_BOM_INQ_COSTED) to display EBOM summary costs.

Navigation:

Engineering > BOMs and Revisions > Review EBOM Information > Costed EBOMs > Costed EBOMs

This example illustrates the fields and controls on the Costed EBOMs page. You can find definitions for the fields and controls later on this page.

Costed EBOMs

*Unit

*Item ID

*Cost Type

*BOM Code

Eff Date

Search

*Cost Version

Routing Code

Depth

BOM Qty Cost as Batch

View Non-Indented Output Costs Chunk Size

Components							Personalize Find <input type="text" value="1 of 1"/> First Last
Lvl	Type	Component ID	Description	Cost Req.	Std Qty UOM	Per	Extended Cost
0				0.0000000			0.0000
Total Cost							

Field or Control	Description
Unit, Item ID, Cost Type, Cost Version, BOM Code, and Routing Code	Select the appropriate information for the BOM that you want to view.
Cost Version	Select an engineering cost version that is valid for the cost type selected. Also, to correctly calculate the total cost, costs for each of the assembly item's purchased components must exist for the cost type and cost version selected. This is accomplished by rolling up the cost type and version within PeopleSoft Cost Management.
BOM Code	<p>As long as the BOM exists, you can enter a BOM code other than the one used for the latest cost type version where a roll-up was performed. In this case, the Output Costs page does not display any cost version cost details, because the cost details do not exist (no roll-up was performed). In addition, if you enter a BOM code that doesn't exist for a cost version, the routing code is deselected and no This Level costs are included in the calculations.</p> <p>When the BOM code is valid for a cost version, then the routing code must be valid for the cost version as well, because this is used to calculate the This Level costs for the inquiry.</p>
Eff Date or Revision	Enter this information for the BOM that you want to view. You can select any valid BOM code, but regardless of what depth you enter, the system calculates all lower levels based on the primary BOM code.

Field or Control	Description
Cost as Batch	<p>If the item and BOM code entered is a multi-output item (that is, it has co-products), then the Cost as Batch check box is selected and is display-only. In this case, the results rendered by the inquiry represent the total cost of the batch (as opposed to one unit of the batch) and the required quantities, and the extended cost calculated is for the entire batch (based on the BOM quantity).</p> <p>If the item is a single output item having a BOM quantity greater than one, you have the option to cost as batch. In this case, you can choose to cost the item in terms of the production of one unit of the end item or choose to cost as batch, in which all component costs and This Level Costs are scaled up based on the BOM quantity (similar to a multi-output item).</p> <p>In other words, the purpose of the Cost as Batch is to allow single output items (which are normally displayed based on a quantity of 1) to have the component and output quantities and costs displayed based on their full BOM quantities. For example, if an item had a BOM quantity of 10 and the check box is deselected, then the costs would appear based on a BOM quantity of 1. If the check box was selected, costs would appear based on a BOM quantity of 10.</p>
View	<p>Select how you want to view summary data: <i>Indented</i> or <i>Non-Indented</i>. The indented option provides an indented (tree) BOM structure for the selected depth.</p>

After you've made your selections, click the **Search** button to display component costed information for as many levels as you entered in the **Depth** field. The system derives the cost of the assembly from the component's This Level and Lower Level costs for the cost type, version, BOM, and routing code selected. It calculates cost for all assemblies and subassemblies that fall within the depth selected. If the BOM code entered is not 1, then the outputs within the **Output Costs** link reflect the outputs for the BOM code entered, and the components listed for level 1 are based on that BOM code. Lower levels always use BOM code 1. The routing code entered is used solely to determine This Level costs included in the calculation for inquiry total costs.

Note: While you can run a Costed EBOMs Summary inquiry for a purchased item that has an EBOM, the system calculates only the material costs, based on the material costs for the components specified and the cost type and version that you select.

Field or Control	Description
Extended Cost	<p>Displays the extended cost, which is the component's cost for the cost type and version specified, multiplied by the cost required quantity standard unit of measure. The Cost Required Qty Std UOM represents the quantity needed for each component to build the item ID specified. This depends on the Cost as Batch setting; if it's selected, it would be the required quantity to build the batch, and if it's not selected it's the required quantity to build one of the items. The Cost Required Qty Std UOM factors in assembly BOM quantity, component quantity per assembly or order, and component yield. Even though they have only a purchased cost associated with them, by-products also appear. If the by-product is a recycle by-product, then the cost is negative; if it's a waste by-product, then the cost is positive, unless the item doesn't have a purchase cost, in which case the cost is zero.</p> <hr/> <p>Note: If the component is displayed as a subassembly, only the This Level costs appear on this page for the subassembly. Lower Level costs for the subassembly appear within the child components of the subassembly.</p>
Total Cost	<p>Displays the total cost, which is the sum of all the extended costs of all components on an EBOM for a specific effectivity date or revision, plus any This Level costs for the item. The system computes the costs for each component, and then sums for the assembly item.</p> <p>For assemblies that have by-products: Even though they have only a purchased cost associated with them, by-products also appear. If it's a recycle by-product, the cost impact is negative and is subtracted from the total cost. If it's a waste by-product, the cost is positive, and is added to the total (unless the item didn't have a purchase cost, in which case the cost is zero).</p>

Revision-Controlled EBOMs: Depth Information

It is best to select the maximum depth for revision-controlled EBOMs.

There are times when the same revision-controlled EBOM may reflect different costs. For example:

If you enter a depth *less than* the maximum number of levels for the costed EBOM, the lower-level costs displayed reflect the costs generated by the original cost roll-up for this cost version and date.

If, however, you enter the *maximum depth* for the costed EBOM, the lower-level costs displayed reflect the most current BOM and routing, not the cost version that you entered on the Costed EBOMs Summary page.

In addition, if changes occur to the EBOM and routing after the cost roll-up, the cost of the EBOM where you have entered a depth less than the maximum may reflect something different from the cost from the maximum depth EBOM. Both of these costed EBOMs are considered correct, depending on the depth that you enter.

The following diagram illustrates the cost calculation for a revision-controlled bill of material. This case can apply to either a manufacturing BOM or engineering BOM:

The following diagram illustrates how your entry in the **Depth** field of the Engineering BOM Costed - Costed EBOMs inquiry page can impact the top-level cost. In this case, component G was replaced with the higher-cost component H on April 1st. The last cost roll up was on March 1st. If the depth field has a value of 1, then the displayed top-level cost on the Engineering BOM Costed - Costed EBOMs inquiry page does not display the new component cost. However, if the depth is 5, then the new component is used and the newer top-level cost is displayed:

Cost calculation example showing impact of depth selection during inquiry

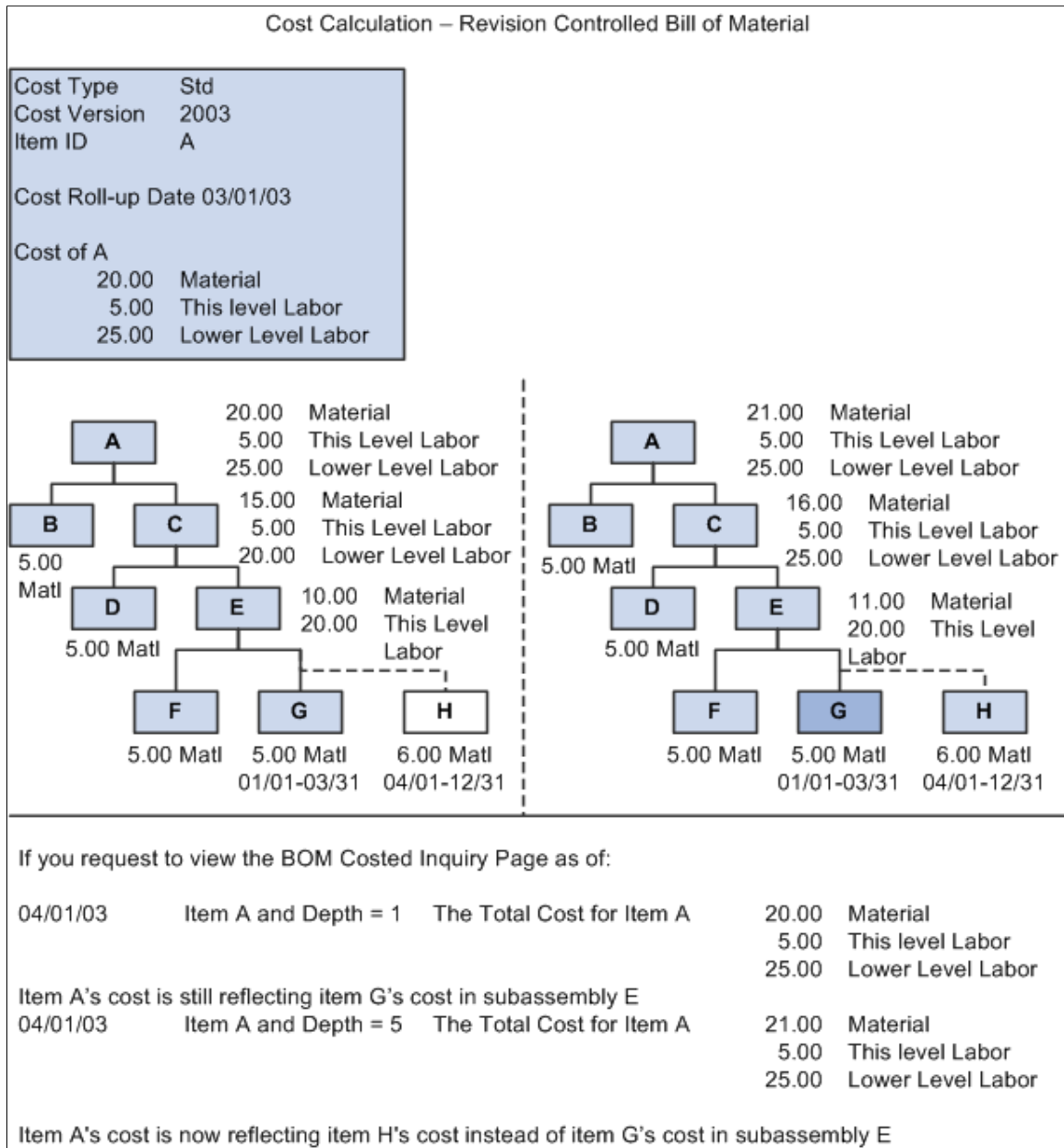

Related Links

"Understanding Production Costs" (PeopleSoft Cost Management)

[Component Detail Costs Page](#)

Output Costs Page

Use the Output Costs page (EN_BOMCOST_OUT_SP) to display, by output type, all lower-level costing details for each co-product based on the costing percentage split.

Navigation:

Click the **Output Costs** link on the Costed EBOMs inquiry page.

Note: Due to rounding differences, you may see a small variance (+ or – 0.0003) between the cost version costs and the inquiry costs in this inquiry. This occurs when the system displays the costed BOM results for an item that's either a batch item or has batch assembly items at lower levels.

Item Cost Details tab

Select the Item Cost Details tab on the Output Costs page.

<i>Field or Control</i>	<i>Description</i>
Cost Version Item Cost	Displays the last stored cost.
Inquiry Item Cost	Displays the new cost of the item being queried.
Delta	Displays the difference between the cost version item cost and the inquiry item cost.

Batch Cost Details tab

You can select this tab only if you selected Cost as Batch on the Costed BOM page.

This tab displays BOM cost broken down by output type. For example, a process has two co-products: A and B. co-product A has a cost allocation percentage of 60, and co-product B has a cost percentage of 40. One row displays A, with 60 percent of the costs, and another row displays B, with 40 percent of the costs.

<i>Field or Control</i>	<i>Description</i>
Inquiry Batch Cost	Displays the total cost from the Costed BOM page multiplied by the cost percentage of the primary product or co-product.

Note: The cost percentages must equal 100.

Related Links

[Engineering BOMs - Header: Outputs Page](#)

"Assigning Associated Primary BOMs" (PeopleSoft Manufacturing)

Component Detail Costs Page

Use the Component Detail Costs page (EN_ITEMCOST_SP) to display EBOM component details.

With this page, you can display the Extended This Level Cost and Extended Lower Level Costs by cost element for the selected component item, cost type, and cost version.

Navigation:

Engineering > BOMs and Revisions > Review EBOM Information > Costed EBOMs > Costed EBOMs

Click a Component ID field value.

<i>Field or Control</i>	<i>Description</i>
Cost Elmnt (cost element)	Displays a category of costs defined by you, such as materials, labor, or overhead.
Extended This Level Cost	Displays the item's extended cost of putting the components together. This cost is also known as the conversion cost.
Extended Lower Level Cost	Displays the item's extended cost of its components prior to their assembly at this level.
Total	The field on the left sums the This Level Costs for all cost elements, and the field on the right sums the Lower Level Costs for all cost elements.

Example

If A is a component on an assembly and is itself a subassembly composed of components B and C, and the cost of B is 20.00, and the cost of C is 30.00, then A's Lower Level Cost is 50.00 (not considering extended costs). If the cost of putting B and C together is 25.00, then A's This Level Cost is 25.00. For the assembly on which A is a component, the top-level assembly's Lower Level Cost is 75.00 (A's This Level Cost plus the Lower Level Cost).

Rounding

PeopleSoft Cost Management calculates the different extended costs by multiplying cost by the calc quantity. It then displays the cost results to four decimal places for viewing purposes. Calc quantity can represent a value from 4 to 10 decimal places. The QPA rounding setting determines the decimal range for the calc quantity.

Note: The content of this section is only part of what you need to know to define QPA rounding. Other relevant information, because it is common to many applications, is located in the *PeopleSoft Application Fundamentals* product documentation.

Related Links

"Setting Up Application-Specific Installation Options" (Application Fundamentals)

Comparing Engineering BOMs

This topic lists common elements and discusses how to compare engineering BOMs.

Pages Used to Compare Engineering BOMs

Page Name	Definition Name	Usage
Compare EBOMs - BOM Selections Page	EG_BOM_COMPARE1E	Compare a baseline BOM to an engineering BOM within the same business unit. You can compare any two EBOMs or compare an EBOM to an MBOM.
BOM Selections - Component Details Page	EG_BOM_COMPARE2	Compare component ID BOM differences, including standard unit of measure and source code.
BOM Selections - Component Details: Attachments Page	EG_BOM_COMPARE8	Compare the component attachment differences between two BOMs. BOM Selections - Component Details Page
BOM Selections - Component Details: Documents Page	EG_BOM_COMPARE7	Compare component document differences for two BOMs. BOM Selections - Component Details Page
BOM Selections - Component Details: Reference Designators Page	EG_BOM_COMPARE9	Compare the reference designator differences between two BOMs. BOM Selections - Component Details Page
BOM Selections - Component Details: Dimensions Page	EG_BOM_COMPARE5	Compare component dimensions for two BOMs. BOM Selections - Component Details Page
BOM Selections - Component Details: Substitutes Page	EG_BOM_COMPARE_SUB	Compare substitute item differences for EBOM comparison.
BOM Selections - Assembly Header: Differences	EG_BOM_COMPARE1D	Compare the assembly differences of two BOMs, specifically BOM types, BOM quantity, and text.

Page Name	Definition Name	Usage
BOM Selections - Assembly Header: Attachments	EG_BOM_COMPARE1C	Compare the assembly attachment differences of two BOMs.
BOM Selections - Assembly Header: Documents	EG_BOM_COMPARE1B	Compare the document differences of two BOMs.
<u>BOM Selections - Assembly Header: Outputs Page</u>	EG_BOM_COMPARE10	Compare the output differences of two BOMs.
EBOM Compare Report	EN_BOM_COMP_REPORT	Select the engineering BOMs, or the manufacturing and engineering BOMs that you want to compare.
EBOM Compare Report - Print Options	EN_BOM_COM_REPORT2	Select details that you want to appear in the Engineering BOM Compare report (ENS1005).

Related Links

[Understanding PeopleSoft Engineering Bills of Material](#)

Common Element Used in This Section

Field or Control	Description
Differences	<p>Displays the differences between the two BOMs. Values are:</p> <ul style="list-style-type: none"> • <i>Added</i>: The component ID has been added to the compare BOM (BOM2). • <i>Deleted</i>: The component has been deleted from the compare BOM (BOM2). <p>The system determines whether a component has been deleted, by comparing the component IDs, operation sequences, and effectivity dates; this is what makes a component unique within a BOM.</p> <ul style="list-style-type: none"> • <i>Chg BOM1</i>: If you have made a component change, you see the components listed. <p>The system lists a change when any information other than component ID, operation sequence, or effective date has changed.</p> <ul style="list-style-type: none"> • <i>Chg BOM2</i>: If you have made a component change, you see the components listed. <p>The system lists a change when any information other than component ID, operation sequence, or effective date has changed.</p>

Compare EBOMs - BOM Selections Page

Use the Compare EBOMs - BOM Selections page (EG_BOM_COMPARE1E) to compare a baseline BOM to an engineering BOM within the same business unit.

You can compare any two EBOMs or compare an EBOM to an MBOM.

Navigation:

Engineering > BOMs and Revisions > Review EBOM Information > Compare EBOMs > BOM Selections

This example illustrates the fields and controls on the Compare EBOMs - BOM Selections page. You can find definitions for the fields and controls later on this page.

Baseline BOM (BOM1)

<i>Field or Control</i>	<i>Description</i>
Item ID	Select an item for the baseline BOM.
BOM Code	Select a BOM code for the baseline BOM. You can select any valid BOM code, but regardless of what depth you enter, the system calculates all lower levels based on the primary BOM code.
Eff Date	Enter the effective date for the baseline BOM if you do not want to use all dates and revisions.
All Dates/Revs	Select to compare all effective dates and revisions for the baseline BOM.

Target BOM (BOM2)

Field or Control	Description
Item ID	Select an item for the baseline BOM.
BOM Code	Select a BOM code for the baseline BOM. You can select any valid BOM code, but regardless of what depth you enter, the system calculates all lower levels based on the primary BOM code.
Eff Date	Enter the effective date for the baseline BOM if you do not want to use all dates and revisions.
All Dates/Revs	Select to compare all effective dates and revisions for the baseline BOM.
Compare BOMs	Click this button to compare the selected BOMs.

BOM Selections - Component Details Page

Use the BOM Selections - Component Details page (EG_BOM_COMPARE2) to compare component ID BOM differences, including standard unit of measure and source code.

Navigation:

Engineering > BOMs and Revisions > Review EBOM Information > Compare EBOMs > BOM Selections > Component Details > Component Details

This example illustrates the fields and controls on the BOM Selections - Component Details: Component Details page. You can find definitions for the fields and controls later on this page.

Differences	Component ID	Description	Comp Rev	Op Seq	Eff Date	Obs Date	Std UOM	Quantity Per	Source Cd
Deleted.	HB9000	Handlebar, Pro Road Racing		40	01/01/1985	12/31/2099	EA	1.0000 Asy	Buy
Added.	HB9001	Handlebar, Mountain		40	01/01/1985	12/31/2099	EA	1.0000 Asy	Buy
Added.	LT3008	White Paint		40	01/01/1985	12/31/2099	GAL	1.0000 Asy	Buy
Deleted.	LT3009	Blue Paint		40	01/01/1985	12/31/2099	GAL	1.0000 Asy	Buy
Added.	PS1002	Pedal, Standard		50	01/01/1985	12/31/2099	EA	2.0000 Asy	Buy
Deleted.	PS1004	Pedal, Deluxe		50	01/01/1985	12/31/2099	EA	2.0000 Asy	Buy
Deleted.	ST8003	Dual Pad Seat, Womans	BB	50	01/01/1985	12/31/2099	EA	1.0000 Asy	Buy
Added.	ST8004	Gellflex Seat, Womans	BB	50	01/01/1985	12/31/2099	EA	1.0000 Asy	Buy

The header data consists of default values from the Compare EBOMs - BOM Selections inquiry page.

Rtg/BOM/PID tab

This page displays routing, BOM, and production ID differences between the selected BOMs.

<i>Field or Control</i>	<i>Description</i>
Subs Exist	If substitutes exist for a component, this field is selected. If no substitutes exist, this field is unavailable for selection.
Sub Supply	Selected if the component is supplied by a subcontractor. If the component is not a subcontracted item, the field is unavailable for selection.

BOM Selections - Component Details: Substitutes Page

Use the BOM Selections - Component Details: Substitutes page (EG_BOM_COMPARE_SUB) to compare substitute item differences for EBOM comparison.

Navigation:

Engineering > BOMs and Revisions > Review EBOM Information > Compare EBOMs > BOM Selections > Component Details > Substitutes

The header data consists of default values from the Compare EBOMs - BOM Selections inquiry page.

Substitute Items tab

The system displays the substitute differences, including the substitute item ID, description, and the original component ID.

Attributes tab

The system displays the substitute differences, including the substitute item ID, operation sequence, effective date, priority, standard unit of measure, and conversion rate.

BOM Selections - Assembly Header: Outputs Page

Use the BOM Selections - Assembly Header: Outputs page (EG_BOM_COMPARE10) to compare the output differences of two BOMs.

Navigation:

Engineering > BOMs and Revisions > Review EBOM Information > Compare EBOMs > BOM Selections > Assy Header > Outputs

The header data consists of default values from the Compare EBOMs - BOM Selections inquiry page.

Dates tab

This page displays output date differences, including information such as output type, output item, operation sequence, and effectivity dates.

Attributes tab

This page displays attribute differences, including information such as output type, output item, standard unit of measure, quantity per, source code, serial control, and resource allocation and cost allocation percentages.

Viewing Item Where-Used Information

This topic discusses how to view item where-used information.

Pages Used to View Item Where-Used Information

<i>Page Name</i>	<i>Definition Name</i>	<i>Usage</i>
<u>Item Where Used Page</u>	EG_BOM_WHEREUSED	View all of the EBOMs on which an item appears. You'll find this information useful when you want to analyze the impact that a change in an item can have on all existing BOMs.
Item Where Used (report)	EN_WHEREUSED_RPT	Generate the Components/Substitutes Where Used Report (ENS2000). You can generate a hard copy report that lists all the EBOMs on which a component appears. You'll find this information useful when you want to analyze the impact that a component change can have on all existing EBOMs or MBOMs.
Item Where Used Express	EN_ITEMWHERE_USED	View the engineering BOMs on which components are used. This information is useful when you want to analyze the impact a change to an item can have on all existing EBOMs.

Item Where Used Page

Use the Item Where Used (inquiry) page (EG_BOM_WHEREUSED) to view all of the EBOMs on which an item appears.

You'll find this information useful when you want to analyze the impact that a change in an item can have on all existing BOMs.

Navigation:

Engineering > BOMs and Revisions > Review EBOM Information > Item Where Used > Item Where Used

This example illustrates the fields and controls on the Item Where Used page: Details tab. You can find definitions for the fields and controls later on this page.

Item Where Used

*Search Components Only Search

Unit US008

BOM State Manufacturing

Item ID: SR2001 Gear Subassembly

*BOM Type Production

Eff Date 01/01/1900

Levels Up 1

*View Non-Indented

Comp Rev A

BOM Code 1

Source Cd Make

Std UOM EA

All Dates/Revs

Top Levels only

Component/Substitute Where Used
Personalize | Find |
First 1-7 of 7 Last

Details
Attributes

Lvl	Item ID	Description	Comp Rev	BOM Code	Op Seq	Quantity
1	MT2000 <-	Professional Road Bike, Womans		1	30	1.0000
1	MT3000 <-	Mountain Bike, Womans		1	30	1.0000
1	MT3010 <-	Mountain Bike, Womans - Limited Edition		1	30	1.0000
1	MT3020 <-	Mountain Bike, Womans - Millennium Edition		1	40	1.0000
1	SR1001 <-	Omega 500 Touring Bike		1	30	1.0000
1	SR1002 <-	Carrera 6000 Hi Performance Road Bike		1	30	1.0000
1	SR1003 <-	Mt. Whitney 3000 Mountain Bike		1	30	1.0000

Field or Control	Description
Search	Select a value to display only certain types of data. Values are: <i>Components Only</i> , <i>Components and Substitutes</i> , <i>Outputs Only</i> , and <i>Substitutes Only</i> .
Unit, Item ID, BOM Type, Eff Date or Revision, and BOM Code.	Enter this information about the item, as appropriate.
Levels Up	Enter 1, to view only the item's parent assembly. The larger the number, the higher the level; for example, level 3 is three levels higher in the BOM structure than the item. To view only the final end item in which the selected item is an item, select Top Levels only . If you have requested more than one level, an arrow appears next to the item's immediate parent in the Item ID field. Note: Do not confuse the Levels Up field with the Depth field on the BOM inquiry pages. Levels Up looks up the BOM structure; Depth looks down the structure. The Levels Up field is available only for BOM code 1.
Search	Click to retrieve the selected item where-used information.

If you selected *Components Only* or *Components and Substitutes*, the system displays all higher-level subassemblies or assemblies that contain the selected item. You also see the levels at which the items appear in the higher-level items. The left arrow (←) in the display points to the item that directly uses the item selected.

Components and Substitutes and *Substitutes Only* appear if the component for the item is a substitute.

If you selected *Outputs Only*, the system displays information by output type, including:

- **Item ID**
- **BOM Code**
- **Op Seq**
- **Output Quantity**

If the component is revision-controlled, a **Comp Rev** field also appears as a search parameter. If you enter a component revision, this page returns all assemblies where that component matches or is blank. If you leave the component revision blank, the inquiry returns assemblies that use any revision of the component.

Related Links

"Component Use Up" (PeopleSoft Manufacturing)

Viewing BOM and Routing Transfer and Copy Data

The system makes a BOM Transfer/Copy Audit page entry for each EBOM transferred or copied to production. You can display all items whose EBOMs or BOMs you have copied or transferred by selecting by viewing the BOM Transfer/Copy Audit page.

Similarly, the system makes a Routing Transfer/Copy Audit page entry for each engineering routing (ERTG) transferred or copied to production. You can display all items whose ERTGs or manufacturing routing (MRTG) you have copied or transferred by viewing the Routing Transfer/Copy Audit page.

Related Links

[Transferring BOMs and Routings](#)

Chapter 7

Structuring Engineering Routings

Understanding Engineering Routings

This topic lists prerequisites and common elements and discusses engineering routings.

Prerequisites

Prior to creating and maintaining engineering routings, you must perform these steps within PeopleSoft Manufacturing:

- Define work centers where jobs or tasks will be performed.
- Define conversion codes, if you want to calculate conversion costs.

These codes can be the same codes as defined for manufacturing.

- Define conversion rates (labor, machine, and overhead rates or costs), if you want to calculate conversion costs.

These rates can be the same as those defined for manufacturing.

When defining engineering routings, you have several options regarding the information that you want to associate with a routing. This information is maintained in PeopleSoft Manufacturing. These steps are optional:

1. Define resources.

Resources can be crews (people), machines, or tools. You can associate resources with a work center.

2. Define the master list of tasks to be performed in the manufacturing process.

Tasks are useful if the same task is performed when manufacturing several items. You need only define the processing information once on the task and then assign the task to the engineering routings of these items.

3. Define count points.

Count points are an automated way to predefine where in the item's routing to record completions and scrap costs. If an operation is designated as a count point, assembly completions must be recorded at that operation. Material is only consumed, and labor and overhead is only earned, up to the previous count point.

Note: Count points can be used only on production IDs.

If you have enabled PeopleSoft Workflow, the system uses the Routing Change workflow to send notification to the manufacturing engineer (or other defined role) that a change has been made to a routing.

See also the product documentation for *PeopleSoft Engineering*, “Delivered Workflows for PeopleSoft Engineering”.

Related Links

"Bills of Material" (PeopleSoft Manufacturing)

"Understanding Routings" (PeopleSoft Manufacturing)

"Understanding Work Centers" (PeopleSoft Manufacturing)

"Understanding Resources" (PeopleSoft Manufacturing)

"Understanding Tasks" (PeopleSoft Manufacturing)

"Understanding the Manufacturing Standard Cost Foundation" (PeopleSoft Cost Management)

"Recording Completed Operations and Scrap for In-House Production IDs" (PeopleSoft Manufacturing)

"Recording End Item Completions Using Count Points" (PeopleSoft Manufacturing)

Common Elements Used in This topic

<i>Field or Control</i>	<i>Description</i>
Routing Type	<p>Select a routing type. Values are:</p> <ul style="list-style-type: none"> • <i>Production</i>: Default routing type. Production routings can be used for standard manufacturing processes. • <i>Rework</i>: You can create rework routings when you have a standard rework process. Rework routings list the routing steps that are commonly used to rework an assembly. <hr/> <p>Note: Rework routings are available when creating rework production IDs.</p> <hr/> <ul style="list-style-type: none"> • <i>Teardown</i>: Use teardown routings when you are breaking an assembly down into its component parts and returning the components back to inventory. Teardown routings can differ from the production routing, but can use any of the existing tasks or work centers defined for production. Teardown outputs can be produced at any operation. No operation that produces teardown outputs can be a subcontracted operation. <hr/> <p>Note: Teardown routings are available when creating teardown production IDs.</p> <hr/>

PeopleSoft Engineering Routings

Engineering departments need the ability to maintain and use engineering routings (ERTGs) without affecting current manufacturing routings. They also can require the ability to create what-if scenarios with routings, determine the costing impact of new and modified routings, and place routings under engineering change control.

Maintaining PeopleSoft Engineering Routings

To define engineering routings (ERTGs), use the Engineering Routing Definition (EN_EROUTING) component.

This topic provides an overview of engineering routing maintenance, lists common elements, and discusses how to maintain engineering routings.

Pages Used to Maintain Engineering Routings

Page Name	Definition Name	Usage
Define Engineering Routings - Summary Page	EN_RTG_SUMMARY	Assign item operations and attach tasks and work centers to an engineering routing.
Define Engineering Routings - Header: Description Page	EN_RTG_HEADER	Define information such as priority and whether you want to copy routings to production and planning.
Define Engineering Routings - Header: Documents	EN_RTG_HEADER_DC	Associate, access, and manage engineering routing header documents in the embedded document management system.
Define Engineering Routings - Header: Attachments Page	EN_RTG_HEADER_ATT	Attach files to the engineering routing header information.
Define Engineering Routings - Operations: Resources Page	EN_RTG_RESOURCE	Define engineering routing resources.
Define Engineering Routings - Operations: Scheduling Page	EN_RTG_SCHED	Select from alternative operation scheduling options for engineering routings, including simultaneous setup and queue, planning intensity, and operation overlap.
Define Engineering Routings - Operations: Times Page	EN_RTG_TIME	Use as part of planning and costing considerations to define engineering routing operation times and rates for an operation.

Page Name	Definition Name	Usage
<u>Define Engineering Routings - Operations: Conv Cost Codes Page</u>	EN_RTG_CONCOST	Associate conversion cost codes with an operation. Conversion rates or costs are associated with each code. The system uses these rates or costs to determine the labor, machine, and overhead cost of the operation.
Define Engineering Routings - Operations: Text	EN_RTG_OP_TXT	Attach text to an operation.
Define Engineering Routings - Operations: Documents	EN_RTG_OP_DC	Associate, access, and manage engineering routing operation documents in the embedded document management system.
<u>Define Engineering Routings - Operations: Attachments Page</u>	EN_RTG_OP_ATT	Specify engineering routing operation attachments.
Engineering Routing Report	RUN_ENS1001	Generate a routing report (ENS1001) of engineering or manufacturing routings.

Understanding PeopleSoft Engineering Routing Maintenance



By using the Define Engineering Routings component, you can create and maintain ERTGs. This includes defining engineering routing code, operations, scheduling options, routing times, conversion costs, routing text, documents, and attachments, and associated tasks, count points, work centers, and resources. You can specify an engineering routing by business unit for any manufactured or purchased item.

Note: You can view, but not modify or add, production routings (MRTGs) from this component. Introduce new changes to production routings by either transferring or copying ERTGs to MRTGs or by maintaining MRTGs directly within PeopleSoft Manufacturing.

When you modify an engineering routing that is a master routing, the impact on other items sharing the routing is reflected within PeopleSoft Engineering; for example, in engineering cost roll-ups. No changes are reflected for items sharing the routing within manufacturing until the engineering routing is transferred back to manufacturing.

Note: Planning and production references in this section are pertinent only after the engineering routing has been copied or transferred to manufacturing. PeopleSoft Engineering has no direct interface with PeopleSoft Supply Planning.

Common Elements Used in This Section

<i>Field or Control</i>	<i>Description</i>
	If there are any outstanding engineering change orders (ECOs) pending for the item, and you have selected the ECO Pending Alert check box on the ECO Item Status page, the system displays this button next to the assembly item ID. Click this button to view information about the pending ECOs associated with this item.
	If the item's routing is a master (or reference) routing currently used by another item, the system displays this button. If you click this button, the system displays the Master Routing Where Used inquiry page. You can use this page to determine whether the changes made to a routing are applicable to all items for which the routing is a reference routing.

Define Engineering Routings - Summary Page

Use the Define Engineering Routings - Summary page (EN_RTG_SUMMARY) to assign item operations and attach tasks and work centers to an engineering routing.

Navigation:

Engineering > Routings > Define Engineering Routings > Summary

Note: You can add engineering routings only for assembly items that are both owned and approved. Additionally, you can maintain routings only for items where the **Used in Mfg** (used in manufacturing) option is selected for the business unit item attributes.

You cannot add a routing for floor stock, planning, expensed, or configured items.

<i>Field or Control</i>	<i>Description</i>
Routing Code	<p>Enter a routing code to give the engineering routing a unique numeric identifier. The system reserves a routing code of <i>1</i> for an item's primary routing and uses this value as the default routing for planning and costing (in PeopleSoft Supply Planning, PeopleSoft Cost Management, and PeopleSoft Manufacturing), including production conversion cost calculations.</p> <p>You can specify up to 98 alternate engineering routings for production, rework, or teardown routing types by entering additional routing codes (greater than <i>1</i>) for the same routing type.</p>
Routing Type	Select a type depending on the kind of operations that you are tracking.

Note: When adding a routing for an item with item status of *Hold* or *Discontinue*, you receive a warning message.

Note: You receive a warning if you modify an item's routing that is used by another item.

Field or Control	Description
Op Seq (operation sequence)	<p>Enter the operation sequence. Increment operation sequence numbers by a set amount (5 or 10) to enable insertion of additional operations at a later date.</p> <p>The operation sequences defined here correspond to the operation sequences that you specified for components on the item's BOM. If you have not assigned operation sequences to the item's BOM, and you want to issue a component to the operation's WIP location, return to the EBOM Maintenance component and associate an operation sequence to each component.</p> <p>If you maintaining a manufacturing BOM, the operation sequences should correspond to the components on the manufacturing BOM.</p> <p>When you assign operation sequences to a component (within either engineering or manufacturing BOM maintenance), the system displays the valid operations when you select an operation sequence from the available options in the EBOM Maintenance component.</p> <hr/> <p>Note: If the assembly has a reference or master routing different from itself, then the Op Seq fields reflect master routing operations on the EBOM and MBOM maintenance pages.</p> <hr/>

If you enter a task code for the operation sequence, the system copies all related task and resource data, including subcontract information, work center, queue, setup, run, and post-production time information to the operation.

If you do not enter a task code, you'll need to enter data manually, including work center, routing time, resource, scheduling options, text attachments, and conversion rate code data, on the subsequent pages. If you haven't predefined tasks, you should examine all succeeding pages to ensure that you set up the correct data for the designated item operation.

If you change the task code on this page, the system deletes the old task information and copies the associated new task information into the item's engineering routing. Once you specify the task on the engineering routing, the system doesn't reflect the changes you make to the task information on the Define Task page and the Task Time page in the Task Definition component.

If you enter a task, the system displays whether the task is subcontracted and displays the work center associated with the task. If you haven't entered a task, you must enter a work center for the operation. You can change whether the task is subcontracted and the work center for this task on this engineering routing without affecting the default task information. If you change the work center, the system automatically deletes the resources defined for the old work center and then adds the resources associated with the new

work center. Additionally, if you are maintaining conversion costs by work center, the system adds the new conversion rates and deletes the old rates.

<i>Field or Control</i>	<i>Description</i>
Count Point	<p>(Optional) Select this check box to define an operation step as an operation count point. A count point indicates where in the operation process you want to record completions and scrap. Count points can be used only on production IDs.</p> <p>The default setting comes from the Task Definition page.</p> <hr/> <p>Important! If you are using count points, the last operation step and any subcontracted operations must be defined as count points.</p> <hr/>

Related Links

Prerequisites

"Recording End Item Completions Using Count Points" (PeopleSoft Manufacturing)

Define Engineering Routings - Header: Description Page

Use the Define Engineering Routings - Header: Description page (EN_RTG_HEADER) to define information such as priority and whether you want to copy routings to production and planning.

Navigation:

Engineering >Routings >Define Engineering Routings >Header >Description

<i>Field or Control</i>	<i>Description</i>
Copy Routing to Production	<p>Select this check box to copy the routing to the operation lists within PeopleSoft Manufacturing. This enables you to track operation details and record production completions at specific operations. If you do not copy the routing to production, the system still uses the routing to calculate costs and calculate planning order and schedule dates.</p> <p>If a rework routing is specified, this field is automatically selected and cannot be deselected.</p>

Field or Control	Description
Copy Routing to Planning	<p>If you are using PeopleSoft Supply Planning, select this check box to schedule, at the operation level, while optimizing resources. The system doesn't copy rework or teardown routings to PeopleSoft Supply Planning as possible production options, so the check box is unavailable for rework or teardown routings.</p> <p>However, if a rework or teardown routing has been copied to production for a specific production ID, that routing becomes the operation list that is used as the production option for that specific production ID. This applies to teardown routings as well.</p>
Priority	<p>Enter a routing priority. Priority specifies the order that PeopleSoft Supply Planning should use to consider alternate routings when planning production. The lower the priority number, the higher the priority. Rework and teardown routings have no priority.</p>

Note: Planning and production references in this section are pertinent only after the engineering routing has been copied or transferred to manufacturing. PeopleSoft Engineering has no direct interface with PeopleSoft Supply Planning.

Related Links

"Defining Items at the Business Unit Level" (PeopleSoft Managing Items)

[Defining Master Routings](#)

Define Engineering Routings - Header: Attachments Page

Use the Define Engineering Routings - Header: Attachments page (EN_RTG_HEADER_ATT) to attach files to the engineering routing header information.

Navigation:

Engineering > Routings > Define Engineering Routings > Header > Attachments

Field or Control	Description
File Ext (file extension)	Select the type of media to attach.
Document ID and Description	Enter the file name and description of the multimedia item that you're attaching
	Click the Attachments button to launch the multimedia object attached to the engineering routing header.

Note: You must set up file extensions in advance on the File Locations page (select **Set Up Financials/Supply Chain > Common Definitions**).

Define Engineering Routings - Operations: Resources Page

Use the Define Engineering Routings - Operations: Resources page (EN_RTG_RESOURCE) to define engineering routing resources.

Navigation:

Engineering > Routings > Define Engineering Routings > Operations > Resources

This example illustrates the fields and controls on the Define Engineering Routings - Operations: Resources page. You can find definitions for the fields and controls later on this page.

Default values for the **Op Seq** (operation sequence), **Task Code**, and **Work Center** fields come from the Define Engineering Routings - Summary page, but they can be changed here.

Field or Control	Description
Continuous Scheduling	Select this check box to complete the corresponding operation in a single run of continuous valid calendar time, with no gaps allowed between shifts.
Ignore Capacity	Select this check box to prevent the PeopleSoft Supply Planning solvers from analyzing and resolving capacity issues that affect the work center. When selected, capacity issues, although not recognized by the solvers, appear in the Supply Planning Violations Workbench if they are before the capacity fence defined for the planning instance. By selecting the Ignore Violations check box on noncritical work centers, you enable the solvers to ignore these work centers and focus on critical work centers for capacity repair. Deselect this check box to generate what-if scenarios.

Field or Control	Description
Crew Size and Machine Resources	You can change crew size and machine resources if you have specified a task. Default values come from the specified task. If you haven't specified a task, the default values come from the work center. Crew size is the number of people at the work center. Machine resources are the number of machines at the work center.

Resources

Default values for operation resources associated with the engineering routing operation are populated by the specified task. If no task is specified, the default values are from the work center. Specifying resources on the engineering routing operation is optional. You can delete existing resources if they aren't appropriate for use with the manufactured item.

Field or Control	Description
Resource Type and Crew/Machine/Tool	<p>To change a primary resource or add additional resources, select the resource type (<i>Primary Crew</i>, <i>Primary Machine</i>, <i>Primary Tool</i>, <i>Alternate Crews</i>, <i>Alternate Machines</i>, and <i>Alternate Tools</i>) and resource (use the Crew/Machine/Tool field) to associate with the operation. The resource must have been previously associated with the work center.</p> <p>You can have only one each of these resource types on a routing:</p> <ul style="list-style-type: none"> • <i>Primary Crew</i> • <i>Primary Machine</i> • <i>Primary Tool</i> <p>However, you can have unlimited resources of these types:</p> <ul style="list-style-type: none"> • <i>Alternate Crews</i> • <i>Alternate Machines</i> • <i>Alternate Tools</i>
Qty Used (quantity used)	If the resource changed or a tool is added, enter the quantity used.

Note: You cannot associate crew and machine resources with subcontracted tasks or operations.

Define Engineering Routings - Operations: Scheduling Page

Use the Define Engineering Routings - Operations: Scheduling page (EN_RTG_SCHED) to select from alternative operation scheduling options for engineering routings, including simultaneous setup and queue, planning intensity, and operation overlap.

Navigation:

Engineering > Routings > Define Engineering Routings > Operations > Scheduling

This example illustrates the fields and controls on the Define Engineering Routings - Operations: Scheduling page. You can find definitions for the fields and controls later on this page.

Default values for the **Op Seq** (operation sequence), **Task Code**, and **Work Center** fields come from the Define Engineering Routings - Summary page, but can be changed here.

If the operation sequence is a count point, the **Count Point** check box is selected. This field is display-only; the value is populated from the Define Engineering Routings - Summary page.

Field or Control	Description
Simultaneous Setup and Queue	<p>Select this check box if setup can occur during the queue time of an operation. If selected, the system considers the longer of the two times when determining production start or end dates.</p> <hr/> <p>Note: You cannot select Simultaneous Setup and Queue for the first operation in an engineering routing. You also cannot select it if you are using PeopleSoft Supply Planning.</p>

Field or Control	Description
Intensity	<p>Determine the basis of your scheduling. You can base the start and end dates of the operation on the operation's <i>Labor Time</i> (labor intensive) or <i>Machine Time</i> (machine intensive). Alternately, you can base the start and end dates on the <i>Longest</i> time (longest of the two times, evaluated for each time type within the operation) or on the <i>Cumulative</i> time (the sum of the <i>Machine Time</i> and <i>Labor Time</i>).</p>
Op Overlap (operation overlap)	<p>Indicate that a subsequent operation can begin prior to the completion of the prior operation. Options include:</p> <ul style="list-style-type: none"> • <i>No Overlap</i>: No operation overlap. • <i>Percentage</i>: An overlap by percentage of elapsed run time completed. <p>If you select <i>Percentage</i>, the Overlap % (overlap percentage) field appears. This is the percentage of processing run time remaining at one operation before the next operation can start. An overlap percentage of <i>100</i> means that the next operation can begin setup at the same time as the current operation run starts. An overlap time of <i>5</i> percent means that 95 percent of the operation run must be completed before the next can start.</p> <hr/> <p>Note: The operation overlap percentage cannot be less than <i>0</i> or more than <i>100</i>, and there can be no overlap on the last engineering routing operation sequence. Operation overlap shouldn't be defined on the operation before a subcontracted operation, because all assemblies and subassemblies must be sent to the subcontractor as a batch. Because the supplier can send the item back in multiple batches, the system allows, on a subcontracted operation, operation overlap for send-ahead quantity and percentage.</p> <hr/> <ul style="list-style-type: none"> • <i>Send Ahead</i>: Overlap by a specific quantity completed at the operation. <p>If you select <i>Send Ahead</i>, the Send Ahead field appears. Enter the number of units that need to be accumulated or finished before they can be sent to the next operation and the next operation can begin. The send-ahead quantity must be a positive number.</p> <hr/> <p>Note: If an operation has a fixed run rate assigned to it, the preceding operation cannot have a send-ahead quantity assigned to it, because fixed run operations assume the entire quantity is available at the beginning of the run. For example, operation 1 cannot have a send-ahead quantity assigned if operation 2 has a fixed run time.</p> <hr/>

Note: For multiple output batch items, the send-ahead quantity or percentage overlap is specified in terms of the BOM quantity, as defined on the primary item's BOM.

Subcontracting

Field or Control	Description
Subcontracted	This option is selected if the operation is being performed by a supplier. You cannot deselect this check box if purchase orders have been created for this outside supplier.
Supplier ID	If the subcontracted supplier was defined at the task level, then the name of the supplier appears in this field. Otherwise, you can select the appropriate supplier for this subcontracted operation.
Subcontracted Item	If this value was defined at the task level, then the item appears in this field. You can change the value in this field. Note: The UOM for the subcontracted item and the end item must be identical.

Define Engineering Routings - Operations: Times Page

Use the Define Engineering Routings - Operations: Times page (EN_RTG_TIME) to use as part of planning and costing considerations to define engineering routing operation times and rates for an operation.

Navigation:

Engineering > Routings > Define Engineering Routings > Operations > Times

This example illustrates the fields and controls on the Define Engineering Routings - Operations: Times page. You can find definitions for the fields and controls later on this page.

Operations

Default values for the **Op Seq** (operation sequence), **Task Code**, and **Work Center** fields come from the Define Engineering Routings - Summary page, but can be changed here.

If you have already associated a task code with an operation, and you change the task, the system deletes the existing task information, including work center, resources, task times, and scheduling options, and adds the new task information for the specific operation. Additionally, if you define conversion rates at the task level, the system deletes the old task rates and adds the new rates.

You can insert a new operation in the same manner as on the Define Engineering Routings - Summary page.

You can change the work center for this task as it applies to this engineering routing sequence. If you change the work center, the system deletes the resources associated with the old work center and adds the new work center's resources. If you maintain conversion rates at the work center level, the system deletes the old rates and adds the new rates.

If the task is subcontracted, the **Sub** (subcontracted) check box is selected, and the **Supplier ID** field appears.

Note: You can specify only labor times for a subcontracted operation.

Operation Times

Default times or run rates are populated using the specified task information. You can modify the manufacturing times or rates for fixed run, post production, run, and setup for the task. Changing the times and run rates here has no effect on the default master task information. If you didn't specify a task, you can enter the times necessary to complete this operation.

If you are changing the operation costing times and run rates after the item's cost has been calculated and updated, the modification results in-process change variances for the item during any production subsequent to the change. These variances continue until the item's cost is recalculated and updated. If you are changing the operation from a regular task to a subcontracted one, you cannot select machine times or rates for the operation.

Select an operation time type and then enter an operation time or operation rate. You can specify operation rates only for planning or costing run time.

If you enter an operation time, then **Time/Rate Unit** field values include *Days*, *Hours*, or *Minutes*. For example, if you enter 5 in the **Op Time** field and *Days* in the **Time/Rate Unit** field, one unit is completed every five days for the operation. The system determines the number of hours in a day by the work center's average daily hours, as defined in the Work Center Definition page.

If you enter an operation rate, then the **Time/Rate Unit** field values include *Units/Day*, *Units/Hour*, or *Units/Minute*. For example, if you enter 3 in the **Op Rate** field and *Units/Day* in the **Time/Rate Unit** field, three units are completed every day for the operation.

Note: If you are defining routing times for a multiple output batch item (at least one co-product on the item's BOM), then both the routing times and rates for costing and planning must be in terms of the in-process batch item's quantity (BOM quantity) and not in terms of a primary or co-product. For example, if the BOM quantity for item ID 10001 is 1000, and the BOM's primary output quantity for 10001 is 500 (for every batch of 1000 you anticipate getting 500), the routing times and rates must be defined in terms of the 1000, and not 500.

You can change any production times or rates for the task, for the specific item engineering routing, without affecting the master task information. If you make a change here, and you want to make the task data identical, you also need to make the change on the Task Time page. The converse is also true. Once you have associated times or rates with an operation, changing the task master data won't affect the data on this page.

Field or Control	Description
Inc. Setup (include setup)	<p>Select this check box for operation lead time calculation, but only for the <i>Planning Labor Setup</i> and <i>Planning Machine Setup</i> operation types.</p> <p>This check box is unavailable for selection in all other cases.</p> <p>Setup, if specified for the first operation, is always included in the lead time calculation. If you don't select Inc. Setup, setup can begin prior to any production units arriving at the work center. The system assumes that setup can occur at any time after the start of production and won't include setup as part of the item's lead time, except at the first operation.</p>

The system allows only queue and in-transit as well as planning and costing labor setup, run, fixed run, and post production times for subcontracted tasks and operations. You cannot specify machine times. If you are using PeopleSoft Supply Planning, you cannot use queue times.

Costing Considerations

To calculate costs for a specific item, operation, or time type, you must have a corresponding costing rate type defined for a particular engineering cost version. For example, if you had a costing fixed run time of five hours defined on the task here, you should also have defined, within PeopleSoft Cost Management, an engineering cost version and conversion code combination.

If you intend to cost the operation using a fixed amount per unit (as opposed to a rate per hour) you must include a corresponding costing operation time type. The costing operation time can represent the amount of time to complete the task, and the system uses the value to calculate earned hours. However, the system uses the amount per unit in calculating the cost, regardless of the time specified. If you don't specify a costing time, the system won't include the per-unit cost, even if there's a rate defined for the code assigned to the task.

Note: You can use the costing information (codes and rates) specified on engineering routings within engineering cost versions, as long as the routing remains in PeopleSoft Engineering. Once the routing is transferred to PeopleSoft Manufacturing, item costs must be generated and updated using a non-engineering cost version.

PeopleSoft Supply Planning Considerations

If you are using PeopleSoft Supply Planning, you need to be aware that:

- If, in the item planning attributes, you've elected to maintain rates based on routings (as opposed to a lead time), you must define labor or machine planning times (setup, run, or fixed run) in order for PeopleSoft Supply Planning to schedule operations and determine work center capacity.
- PeopleSoft Supply Planning doesn't consider queue times, even if they are specified for the task.
- If you have indicated that setup isn't included for scheduling purposes (setup can begin at any time after the start of production), the system won't consider setup for capacity planning purposes.

Note: PeopleSoft Engineering has no direct interface with PeopleSoft Supply Planning, but these PeopleSoft Supply Planning considerations apply once you transfer the engineering routing to PeopleSoft Manufacturing.

Related Links

"Understanding Work Centers" (PeopleSoft Manufacturing)

"Understanding Tasks" (PeopleSoft Manufacturing)

"Defining the Standard Cost Foundation" (PeopleSoft Cost Management)

Define Engineering Routings - Operations: Conv Cost Codes Page

Use the Define Engineering Routings - Operations: Conv Cost Codes (conversion cost codes) page (EN_RTG_CONCOST) to associate conversion cost codes with an operation.

Conversion rates or costs are associated with each code. The system uses these rates or costs to determine the labor, machine, and overhead cost of the operation.

Navigation:

Engineering > Routings > Define Engineering Routings > Operations > Conv Cost Codes

This example illustrates the fields and controls on the Define Engineering Routings - Operations: Conv Cost Codes page. You can find definitions for the fields and controls later on this page.

Resources	Scheduling	Times	Conv Cost Codes	Text	Documents	Attachments
Business Unit	US008					
Item ID	LT5000		Std UOM	EA	Source	Buy
	Standard Wheel Subassembly				Cum Yield %	100.0000
Routing Code	1		Routing State	Engineering	Routing Type	Production

*Op Seq		Task Code	*Work Center
10		WHEEL Wheel Assembly	WHEEL Wheel Subassembly
		Conversion Code	4402 Assembler
		First Conversion Ovhd Code	6501 Assembly
		Second Conversion Ovhd Code	6506 Support
		Third Conversion Ovhd Code	
		Fourth Conversion Ovhd Code	

Default values for the **Op Seq** (operation sequence), **Task Code**, and **Work Center** fields come from the Define Engineering Routings - Summary page, but can be changed here. If you are maintaining conversion rates at the work center level, the system displays the conversion codes associated with the operation's work center. If you are maintaining conversion rates at the task level, and you entered a task code, the system displays the conversion codes associated with the operation's task.

<i>Field or Control</i>	<i>Description</i>
Conversion Code	To change the labor, machine, or overhead cost for a specific operation on an engineering routing, select the conversion code that the system uses to determine the new labor and machine costs.
First Conversion Ovhd Code (first overhead conversion code) Second Conversion Ovhd Code (second overhead conversion code) Third Conversion Ovhd Code (third overhead conversion code), and Fourth Conversion Ovhd Code (fourth overhead conversion code)	Select up to four conversion overhead codes. The system uses these codes to calculate the overhead costs associated with the operation.

Note: If your labor or machine rate is in cost per unit, and you want to include the cost in the cost roll-up calculation, you must have selected a corresponding costing rate type. For example, if the labor run rate (cost) is 0.50 USD per unit, the routing operation must have an entry for costing labor run time in order for the 0.50 USD to be included in the operation's cost.

The rates displayed are the current rates that are used in production to calculate earned labor, machine, and overhead costs. These costs are copied into a frozen production rate record during the production cost update and inventory revaluation process and are based on the rates associated with the cost type and version used to calculate the new production costs.

Define Engineering Routings - Operations: Attachments Page

Use the Define Engineering Routings - Operations: Attachments page (EN_RTG_OP_ATT) to specify engineering routing operation attachments.

Navigation:

Engineering > Routings > Define Engineering Routings > Operations > Attachments

Default values for the **Op Seq** (operation sequence), **Task Code**, and **Work Center** fields come from the Define Engineering Routings - Summary page, but can be changed here. Specify the operation sequence that requires the attachment.

<i>Field or Control</i>	<i>Description</i>
File Ext (file extension)	Select the type of media to attach.
Document ID and Description	Enter the file name and description of the multimedia item that you're attaching.

Note: You must set up file extensions in advance on the File Locations page (select **Set Up Financials/Supply Chain > Common Definitions**).

Defining Master Routings

To assign an item family routing, use the Item Family Routing Assignment (EN_RTG_FAMILY) component. To assign a routing to a specific group of items, use the Item Group Routing Assignment (EN_RTG_GROUP) component.

You can define master or reference routings in PeopleSoft Inventory with the Define Business Unit Item - Manufacturing: General page. If many items have the same processing steps, you can create a master routing that many items can use as their individual routing.

See "Defining and Viewing Master Routings" (PeopleSoft Manufacturing).

Pages Used to Define Master Routings

<i>Page Name</i>	<i>Definition Name</i>	<i>Usage</i>
Define Business Unit Item - Manufacturing: General	MFG_ATTRIB	Define the reference item routing to be used for the master routing.
Item Family Routing	EN_RTG_FAMILY	Designate the item whose routing will be the representative routing for the selected item family.
Item Group Routing	EN_RTG_GROUP	Designate the item whose routing will be the representative routing for the selected item group.
Master Routing Where Used (inquiry)	EN_RTG_MST_WH_USED	View master routing where used information for an item.
Eng Master Rtg Where Used Rpt (engineering master routing where used report)	RUN_ENS1003	Generate the Engineering Master Routing Where Used Report (ENS1003).

Copying and Transferring Engineering Routings

Instead of entering new engineering routings from scratch, you may find it easier to copy or transfer them and then make modifications.

This topic discusses how to copy and transfer engineering routings.

Pages Used to Copy and Transfer Engineering Routings

<i>Page Name</i>	<i>Definition Name</i>	<i>Usage</i>
<u>Copy Routing Page</u>	EG_RTG_COPY	Copy routing data from one item to another within a business unit or across business units. The copy function can also be used to transfer information between manufacturing and engineering, depending on business unit options.
<u>Copy Routing Detail Page</u>	EG_RTG_COPY_DET	Review the data that the system will copy.
<u>Routing Transfer/Copy Audit Page</u>	EG_RTG_AUDIT	Display all items whose manufacturing or engineering routings you have copied or transferred.

Copy Routing Page

Use the Copy Routing page (EG_RTG_COPY) to copy routing data from one item to another within a business unit or across business units.

The copy function can also be used to transfer information between manufacturing and engineering, depending on business unit options.

Navigation:

Engineering > Routings > Copy Engineering Routings > Copy Routing

This example illustrates the fields and controls on the Copy Routing page. You can find definitions for the fields and controls later on this page.

The screenshot shows the 'Copy Routing' page with two tabs: 'Copy Routing' and 'Copy Routing Detail'. The 'Copy Routing' tab is active. It is divided into three main sections: 'Source Routing', 'Target Routing', and 'Operations'.

Source Routing: Includes fields for *Unit (US008), *Item ID (MT2000), *Routing Type (Production), and *Routing Code (1). A dropdown menu for *From/To is set to 'Manufacturing to Engineering'. There are also fields for Cumulative Yield % and Std UOM, and a Search button.

Target Routing: Includes fields for *Unit (US001), *Item ID, Routing Code (1), Cumulative Yield %, and Std UOM. An Edit Rtg button is present.

Operations: A table with columns: Op Seq, Task Code, Description, Work Center, Description, and Yield %. The table shows one row with a Yield % of 100.0000. Navigation controls like 'Personalize', 'Find', 'View All', and 'First 1 of 1 Last' are visible at the top of the table.

Source Routing

<i>Field or Control</i>	<i>Description</i>
From/To	You can copy routings from PeopleSoft Engineering to PeopleSoft Engineering, PeopleSoft Engineering to PeopleSoft Manufacturing, or from PeopleSoft Manufacturing to PeopleSoft Engineering.
Item ID	Select the item whose routing to copy or transfer.
Routing Code	Select the routing code for the source business unit and item ID combination.
Routing Type	Select a routing type for the source routing. Once you select a routing type, the system automatically selects the same routing type for the target routing.
Search	Click this button to display the engineering routing information associated with source business unit and item.

Target Routing

<i>Field or Control</i>	<i>Description</i>
Item ID and Unit	To use one item's engineering routing as the basis for the engineering routing of another item with similar processing, enter the same business unit for both the source and target. You cannot select as the target an item with a source code of Floor Stock, Expense, or Planning.
Routing Code	Enter a routing code for the target routing.
Copy	Select this check box to copy any specific row of data.
Sub (subcontracted)	Selected if the operation is subcontracted.
Count Point	Selected if the source routing or target routing contains an operation sequence that is a count point.
Save	Click to copy the routing.

Copy Routing Detail Page

Use the Copy Routing Detail page (EG_RTG_COPY_DET) to review the data that the system will copy.

Navigation:

Engineering > Routings > Copy Engineering Routings > Copy Routing Detail

This example illustrates the fields and controls on the Copy Routing Detail page. You can find definitions for the fields and controls later on this page.

The screenshot shows the 'Copy Routing Detail' page with the following sections:

- Target Routing:** Unit: US008, Item ID: MT2000, Professional Road Bike, Womans, Std UOM EA. Includes an 'Edit Rtg' button.
- Copy Options:** A grid of checkboxes for copying various elements:
 - Copy Operation Times
 - Copy Operation Resources
 - Copy Operation Att
 - Copy Operation Docs
 - Copy Operation Text
 - Copy Assembly Docs
 - Copy Assembly Att
 - Copy Assembly Text
 Includes 'View Source', 'View Target', and 'Apply' buttons, and a 'Same as Except' dropdown menu.
- Operations:** A table with columns: Op Seq, Task Code, Description, Work Center, Description, Yield %. Shows one row with Op Seq '0' and Yield % '100.0000'. Includes navigation controls like 'Personalize', 'Find', 'View All', 'First', '1 of 1', 'Last'.

You can copy the associated routing operation times, resources, text, attachments, and documents. You can also copy the assembly text, attachments, and documents.

<i>Field or Control</i>	<i>Description</i>
Copy	When the source item's engineering routing is first displayed, all Copy check boxes are selected. You can choose which operation to copy or not by deselecting the appropriate check boxes.

Field or Control	Description
Same as Except	<p>You can also control which operations to copy by using this field.</p> <p>If you want to copy only a few operations, select the <i>Exclude All</i> option, and click the Apply button. This deselects all the Copy check boxes. You can then select only the operations that you want to copy.</p> <p>As an alternative, you can exclude by range, by selecting <i>Exclude Op Seq Range</i> (exclude operation sequence range). When you select this option, the system displays the From Seq Nbr (from sequence number) and To Seq Nbr (to sequence number) fields. You can enter the range of operations that you want to exclude and then click the Apply button. You can do multiple iterations of ranges, clicking the Apply button after you select each range.</p> <p>If you have deselected the operations' check boxes and want to select them, select <i>Include All</i> or <i>Include Op Seq Range</i>. These options work the same as <i>Exclude All</i>, except that now the Copy check boxes are selected for all operations or for the range of operations specified.</p>
View Target	Click this button to see what the target item's engineering routing will look like when copied.
View Source	Click this button to see the source item's engineering routing and the operations selected to copy.

If the business unit, item ID, engineering routing type, and routing code combination already exists as the target, the system prompts you to overwrite the existing routing. If you overwrite the engineering routing, the system deletes the target routing and replaces it with the source routing.

When you click **Save**, the system completes the copy. At that time, the system activates the **Edit Rtg** (edit routings) button; by clicking it, you can edit the source item's engineering routings on the Define Engineering Routings - Summary page.

When you copy routings from one item to another, you cannot copy document associations to the new item. To make copies of the actual documents for the new item routing, you must first copy the documents within Documentum and then associate the copied documents to the new item routing.

Routing Transfer/Copy Audit Page

Use the Routing Transfer/Copy Audit page (EG_RTG_AUDIT) to display all items whose manufacturing or engineering routings you have copied or transferred.

Navigation:

Engineering > Routings > Routing Transfer/Copy Audit

You can also transfer engineering routings and view them (as well as on your routing copies) using the same process that you use for transferring BOMs.

See [Transferring BOMs and Routings](#).

Deleting Engineering Routings

You can also delete engineering routings.

Page Used to Delete Engineering Routings

<i>Page Name</i>	<i>Definition Name</i>	<i>Usage</i>
Delete Engineering Routings Page	EG_RTG_DELETE	Delete routings for a range of items.

Delete Engineering Routings Page



Use the Delete Engineering Routings page (EG_RTG_DELETE) to delete routings for a range of items.

Navigation:

Engineering > Routings > Delete Engineering Routings > Delete Engineering Routings

This example illustrates the fields and controls on the Delete Engineering Routings page. You can find definitions for the fields and controls later on this page.

<i>Field or Control</i>	<i>Description</i>
From Item ID, To Item ID, Routing Type, and Routing Code	Select values for the routing to delete.
Search	Click to retrieve the selected routings.

Field or Control	Description
Delete?	Select this check box for any item whose routing that you want to delete. You can also deselect the check box for any routings that you don't want to delete.
	Click the Select All button to select all the Delete? check boxes.
	Click the Deselect All button to deselect all the Delete? check boxes.

Comparing Engineering Routings

Within the same business unit, you can extensively compare any two engineering routings or compare an engineering routing to a manufacturing routing.

This topic lists common elements and discusses how to compare engineering routings.

Pages Used to Compare Engineering Routings

Page Name	Definition Name	Usage
Routing Comparison - Rtg Selections Page	EG_RTG_INQ_CMP	Select engineering routings to compare.
Routing Comparison - Header: Details Page	EG_RTG_HDR_CMP	Display routing header data for both routings being compared.
Routing Comparison - Header: Documents Page	EG_RTG_HDC_CMP	Compare header document differences of two routings. Routing Comparison - Header: Details Page
Routing Comparison - Header: Attachments Page	EG_RTG_HATT_CMP	Compare the header attachment differences of two routings. Routing Comparison - Header: Details Page
Routing Comparison - Operations: Details Page	EG_RTG_OPS_CMP	Compare operation differences of two routings.
Routing Comparison - Operations: Resources Page	EG_RTG_RSRC_CMP	Compare operation resource differences of two routings.

Page Name	Definition Name	Usage
<u>Routing Comparison - Operations: Times Page</u>	EG_RTG_TIME_CMP	Compare the operation time differences of two routings.
Routing Comparison - Operations: Documents	EG_RTG_OPDC_CMP	Compare operation document differences of two routings.
Routing Comparison - Operations: Attachments	EG_RTG_OPAT_CMP	Compare operation attachment differences of two routings.
Routing Compare Report	RUN_ENS1002	Use the Routing Compare report (ENS1002) to compare two engineering routings, an engineering routing and a manufacturing routing, or two routings for the same item, based on two routing codes.

Common Elements Used in This Section

Field or Control	Description
	Click the Item Search button to select a different item.
Differences	<p>Displays the differences between two routings. If you have made a change to routing operations, you see the routings listed as <i>Chg RTG1</i> and <i>Chg RTG2</i>, respectively. The system lists a change when any information differs between two matching operation sequences. Differences include:</p> <ul style="list-style-type: none"> • <i>Added</i>: An element has been added to the engineering routing (RTG2). • <i>Deleted</i>: An element has been deleted from the engineering routing (RTG2). • <i>Chg RTG1</i>: You have made a change to routing operations for RTG1. <p>The system lists a change when any information differs between two matching operation sequences.</p> <ul style="list-style-type: none"> • <i>Chg RTG2</i>: You have made a change to routing operations for RTG2. The system lists a change when any information differs between two matching operation sequences.

Routing Comparison - Rtg Selections Page

Use the Routing Comparison - Rtg Selections (routing comparison - routing selections) page (EG_RTG_INQ_CMP) to select engineering routings to compare.

Navigation:

Engineering > Routings > Routing Comparison > Rtg Selections

This example illustrates the fields and controls on the Routing Comparison - Rtg Selections page. You can find definitions for the fields and controls later on this page.

The screenshot shows the 'Rtg Selections' page with the following fields and controls:

- Unit:** A text input field containing 'US008' with a search icon.
- *Routing Type:** A dropdown menu set to 'Production'.
- Compare Routings:** An orange button.
- Baseline Routing (RTG1):** A section with:
 - Routing State:** A dropdown menu set to 'Engineering'.
 - Item ID:** A text input field with search and refresh icons.
 - *Routing Code:** A text input field containing '1' with a search icon.
- Target Routing (RTG2):** A section with:
 - Routing State:** A dropdown menu set to 'Engineering'.
 - Item ID:** A text input field with search and refresh icons.
 - *Routing Code:** A text input field containing '1' with a search icon.
- Notify:** An orange button with a bell icon.

Baseline Routing (RTG1)

The default value for the **Routing State** field is *Engineering*, but you can also select *Manufacturing*.

Select an item ID and a routing code for the first routing that you're using for this comparison.

Target Routing (RTG2)

The default value for the **Routing State** field is *Engineering*.

Select an item ID and a routing code for the target routing.

Click the **Compare Routings** button to display the two routing comparisons.

Routing Comparison - Header: Details Page

Use the Routing Comparison - Header: Details page (EG_RTG_HDR_CMP) to display routing header data for both routings being compared.

Navigation:

Engineering > Routings > Routing Comparison > Header > Details

This example illustrates the fields and controls on the Routing Comparison - Header: Details page. You can find definitions for the fields and controls later on this page.

The screenshot shows the 'Header' tab of the Routing Comparison interface. It displays two routing cards side-by-side: 'Baseline Routing (RTG1)' and 'Manufacturing Routing (RTG2)'. Both cards show 'Rtg State' as Engineering, 'Item ID' as MT2000 (Professional Road Bike, Womans) and MT3000 (Mountain Bike, Womans) respectively, and 'Routing Code' as 1. Below the cards is a table with columns: Routing, Description / Short Descr, Copy to Prdn., Copy to Planning, and Text. The table lists RTG1 and RTG2 with their respective descriptions and priority levels. A 'Notify' button is located at the bottom left of the page.

Routing	Description / Short Descr	Copy to Prdn.	Copy to Planning	Text
RTG1	Pro Road Bike, Wmn Pro Road Priority 1	<input checked="" type="checkbox"/>	<input checked="" type="checkbox"/>	
RTG2	Mountain Bike, Womans Mt Bike Wm Priority 1	<input checked="" type="checkbox"/>	<input checked="" type="checkbox"/>	

The system displays the routing header data for both routings, including routing, description, priority, and text, and whether the routing is to be copied to production or PeopleSoft Supply Planning.

Routing Comparison - Operations: Details Page

Use the Routing Comparison - Operations: Details page (EG_RTG_OPS_CMP) to compare operation differences of two routings.

Navigation:

Engineering > Routings > Routing Comparison > Operations > Details

This example illustrates the fields and controls on the Routing Comparison - Operations: Details page. You can find definitions for the fields and controls later on this page.

The screenshot shows the 'Operations' tab of the Routing Comparison interface. It displays two routing cards side-by-side: 'Baseline Routing (RTG1)' and 'Manufacturing Routing (RTG2)'. Below the cards is an 'Operation Details' table with columns: Differences, Op Seq, Task Code, Description, Count Point, Sub, and S/Q. The table lists 'Chg RTG1' and 'Chg RTG2' with their respective operation sequences and task codes. A 'Notify' button is located at the bottom left of the page.

Differences	Op Seq	Task Code	Description	Count Point	Sub	S/Q
Chg RTG1	40	PAINT	Prime and Paint	<input type="checkbox"/>	<input type="checkbox"/>	<input type="checkbox"/>
Chg RTG2	40	SUB-1	Subcontracted Painting	<input type="checkbox"/>	<input checked="" type="checkbox"/>	<input type="checkbox"/>

This page displays differences in operation sequence, task code, simultaneous setup and queue (not available if PeopleSoft Supply Planning is installed) and other information.

Resources Tab

The system displays the operation sequence, work center, crew size, and machine resources.

Conversion/Overheads Tab

The system displays the operation sequence, conversion code and description, as well as the conversion overhead codes

Supplier Details Tab

The system displays the operation sequence, supplier ID, and supplier name. You can access the supplier fields only if the operation is subcontracted.

Subcontracted Tab

This page displays the differences associated with the subcontracted operations.

Text Tab

The system displays the operation sequence and any associated operation text.

Routing Comparison - Operations: Resources Page

Use the Routing Comparison - Operations: Resources page (EG_RTG_RSRC_CMP) to compare operation resource differences of two routings.

Navigation:

Engineering > Routings > Routing Comparison > Operations > Resources

This example illustrates the fields and controls on the Routing Comparison - Operations: Resources page. You can find definitions for the fields and controls later on this page.

The screenshot shows the 'Operations' tab of the Routing Comparison - Resources page. It features two comparison boxes for 'Baseline Routing (RTG1)' and 'Manufacturing Routing (RTG2)'. Below these is a table titled 'Operation Resources' with columns for Differences, Op Seq, Resource Type, Crew/Machine/Tool, Description, Qty Used, and Priority.

Differences	Op Seq	Resource Type	Crew/Machine/Tool	Description	Qty Used	Priority
DeltD CC	40	Primary Crew	PAINT01	Painting Crew 1		10
DeltD CC	40	Alt Crew	PAINT02	Painting Crew 2		10
DeltD MC	40	Primary Machine	PAINT01	Painting Equipment 1		10

The system displays the operation sequence; resource type; crew, machine, or tool information; the quantity used; and priority.

Routing Comparison - Operations: Times Page

Use the page (EG_RTG_TIME_CMP) to compare the operation time differences of two routings.

Navigation:

Engineering > Routings > Routing Comparison > Operations > Times

This example illustrates the fields and controls on the Routing Comparison - Operations: Times page. You can find definitions for the fields and controls later on this page.

Rtg Selections		Header		Operations		
Details		Resources		Times		
Documents		Attachments				
Unit US008		Rtg Type Production				
Baseline Routing (RTG1) Rtg State Engineering Item ID MT2000 Professional Road Bike, Womans Routing Code 1			Manufacturing Routing (RTG2) Rtg State Engineering Item ID MT3000 Mountain Bike, Womans Routing Code 1			
Operation Times Personalize Find First 1-6 of 6 Last						
Differences	Op Seq	Time / Resource Type	Op Time	Time Unit	Op Rate Rate Unit	Inc. Setup
Deleted	40	Planning Labor Fixed Run	15.00	Minutes		<input type="checkbox"/>
Added	40	Planning Labor Run	0.00		200.00 Units/Hour	<input type="checkbox"/>
Deleted	40	Planning Machine Fixed Run	1.00	Hours		<input type="checkbox"/>
Deleted	40	Costing Labor Fixed Run	15.00	Minutes		<input type="checkbox"/>
Added	40	Costing Labor Run	0.00		200.00 Units/Hour	<input type="checkbox"/>
Deleted	40	Costing Machine Fixed Run	1.00	Hours		<input type="checkbox"/>

The system displays the operation sequence, time or resource type, operation time, time unit, operation rate, rate unit, and any operation times.

Chapter 8

Costing Items That Reside Within PeopleSoft Engineering

Using PeopleSoft Cost Management Functionality to Cost Items Within PeopleSoft Engineering

You can apply all PeopleSoft Cost Management data and processes to calculate the cost of items within PeopleSoft Engineering. These include:

- Using any PeopleSoft Cost Management cost foundation data such as cost types, elements, groups, conversion codes, and conversion overhead codes when determining engineering BOM costs.
- Defining engineering cost versions.
- Defining conversion rates and conversion overhead rates for engineering cost versions.
- Maintaining forecasted and additional item costs that are specific to an engineering cost version.
- Copying cost structures, as well as item costs and rates, between non-engineering and engineering cost versions.
- Rolling up engineering cost versions.
- Viewing item costs generated for engineering versions and comparing regular and engineering cost versions.
- Viewing costed engineering BOMs.

Calculating Item Costs for Items Within PeopleSoft Engineering

PeopleSoft Cost Management uses this information when calculating item costs for items within PeopleSoft Engineering:

- Engineering cost version data.
- Engineering BOMs or manufacturing BOMs, depending on the option that you select.
- Engineering routings or manufacturing routings, depending on the option that you select.

PeopleSoft Cost Management bases any engineering cost roll-up on a master routing if you have defined them for specific items.

Related Links

"Understanding the Manufacturing Standard Cost Foundation" (PeopleSoft Cost Management)

Chapter 9

Creating Engineering Change Requests (ECRs)

Understanding PeopleSoft Engineering ECRs

To more efficiently manage, organize, and prioritize the product change process within your organization, PeopleSoft Engineering provides ECR functionality. With ECRs you can:

- Report product defects.
- Suggest improvements.
- List items and related affected information.

Note: ECRs are not required within PeopleSoft Engineering. You can use engineering change orders (ECOs) with or without them.

Related Links

[Examining the PeopleSoft Engineering Product Strategy](#)

Prerequisites

To use priority, reason, and action codes, you need to define the codes before using the ECR-related pages. To have the system automatically generate your ECR numbers, set up automatic numbering for ECRs by using the Automatic Numbering page.

You need to define revisions prior to selecting them on the Items Affected or ECR Header pages.

If you will use the embedded document management system to access ECR and ECR item documents, you can define what function buttons will be available on the ECR document management pages by using the Documentum Component Options page.

Related Links

[Defining Engineering Codes](#)

"Setting Up Document Management Options" (Application Fundamentals)

[Understanding Document Management in PeopleSoft Engineering](#)

Creating and Maintaining ECRs

This topic lists common elements and discusses how to create and maintain ECRs.

Pages Used to Create and Maintain ECRs

Page Name	Definition Name	Usage
<u>Maintain ECRs - Header: Header Page</u>	EG_ECR_HEADER	Maintain ECR header information including items affected data. For quick entry, this page contains all fields required for the ECR.
<u>Maintain ECRs - Header: Reason/Action Page</u>	EG_ECR_REASONS	(Optional) Associate reason and action codes with an ECR.
Maintain ECRs - Header: Documents	EG_ECR_DC	Associate, access, and manage pertinent ECR documents in the embedded document management system.
<u>Maintain ECRs - Header: Attachments Page</u>	EG_ECR_ATT	Attach multimedia objects, or files, that relate directly to the ECR. Once attached, you can view these objects directly from this page.
Maintain ECRs - Items Affected: Detail	EG_ECR_ASSY	Associate one or more new, changing, or impacted items to a specific ECR. You can also optionally add or edit revisions and EBOMs.
Maintain ECRs - Items Affected: Reason/Action	EG_ECR_ASSY_RES	(Optional) Associate reason and action codes for each item affected by an ECR.
Maintain ECRs - Items Affected: Document	EG_ECR_ASSY_DC	Associate, access, and manage pertinent item documents in the embedded document management system.
Maintain ECRs - Items Affected: Attachment	EG_ECR_ASSY_ATT	Attach multimedia objects, or files, that relate to the affected item. Once attached, you can view these objects directly from this page.
Approve/Convert ECRs	EG_ECR_APPROVAL	Change the status of an ECR and optionally convert ECRs into ECOs.

Related Links

[Select Assemblies by Items Where Used Page](#)

Common Element Used in This Section

<i>Field or Control</i>	<i>Description</i>
Where Used	Click this link to access the Select Assemblies by Items Where Used page. Use this page to find the item's information needed to populate the Items Affected region of the page.

Maintain ECRs - Header: Header Page

Use the Maintain ECRs - Header: Header page (EG_ECR_HEADER) to maintain ECR header information including items affected data.

For quick entry, this page contains all fields required for the ECR.

Navigation:

Engineering > Engineering Changes > Maintain ECRs > Header > Header

This example illustrates the fields and controls on the Maintain ECRs - Header: Header page. You can find definitions for the fields and controls later on this page.

The screenshot displays the 'Maintain ECRs - Header: Header Page' interface. At the top, there are tabs for 'Header' and 'Items Affected'. The 'Header' tab is active, showing fields for Unit (US008), ECR Number (ECR0000005), Status (Pending), Description (Wheel Spokes Upgrade), and Comments (Modify wheel spokes used on Mountain Bike). There are also fields for Priority Code (MED), Department (31000), and Requestor (Blake, Scott). A 'Created on' field shows 08/16/2000 4:18PM. Below the header information is a table titled 'Items Affected' with columns for *Type, *Item ID, Description, From Rev, Eff Rev, and Eff Date. Two items are listed: 'Wheel Spokes, Aluminium' and 'Gear Subassembly'. The interface includes navigation and utility buttons like 'Personalize', 'Find', 'View All', 'Send Email to Suppliers', and 'Supplier Access List'.

<i>Field or Control</i>	<i>Description</i>
ECR Number	Displays <i>NEXT</i> , if this is a new ECR and you are using automatic numbering. You can also manually number the ECR.

Field or Control	Description
Status	Displays <i>Pending</i> , when you add an ECR. This status represents the overall state of the ECR. Other statuses include <i>Canceled</i> , <i>Denied</i> , <i>Approved</i> , and <i>Converted</i> .
Not Accessible by Suppliers	If you are using PeopleSoft Engineering, this check box is available; select it to prevent access to a specific ECR. Therefore, if suppliers have been granted access with the BOM Access by Supplier page in PeopleSoft Manufacturing, you can deny them access to a specific ECR.
Priority Code	Select the change request's priority code. You define priority codes, which denote an ECR's using the Engineering Priority Codes page.
Requestor and Department	Enter a requestor and department responsible for the ECR. Departments are defined in the PeopleSoft General Ledger business unit.
Created on	Displays by default the current date and time, when you enter an ECR.

Items Affected

Field or Control	Description
Type	<p>Select the type of change. Values are:</p> <ul style="list-style-type: none"> • <i>Chg</i> (change): The ECR requests a change to an existing item. • <i>New</i>: The ECR requests a new item to be introduced. • <i>Imp</i> (impacts): A changed or new item impacts this item. <p>For example, a new or changed component item has an effect on the assembly item.</p>
Item ID	<p>Select the changed, impacted, or new item ID. You can specify Make, Buy, Floor Stock, or Expensed items; however, you cannot specify Planning items.</p> <p>If the request is for a new item ID that does not exist on the Item Definition page, you can enter a placeholder item here. You can associate multiple items with a single ECR.</p> <hr/> <p>Note: If you list an impacted item, you must also list the corresponding new or changed item that impacts it.</p> <hr/>

Field or Control	Description
From Rev (from item revision)	<p>Enter the originating revision on which you are basing the change. If the item ID is revision-controlled, then you can access this field. If the item ID is not revision-controlled, this field is display-only.</p> <hr/> <p>Note: The from and effective revisions need to be defined with the Revision Maintenance page prior to using them here. You can add multiple ECRs that affect the same item revision.</p> <hr/>
Eff Rev (effective item revision)	<p>Select the new revision that will be in effect after the change is implemented. If the item ID is revision-controlled, you can access this field; otherwise, it is display-only. You must have already defined this revision in the system, and the effective item revision can't have a start date that is prior to the From Rev. After you enter the effective revision, the system displays the start date of the revision in the Eff Date (effective date) field.</p> <p>If the item isn't revision-controlled, you can enter the effective date for the change. Enter the new effectivity date for which the changes will be in effect.</p> <p>Both Eff Rev and Eff Date fields are for informational purposes only. If you make changes to the BOM, the component ID effective and obsolete dates or revisions on the BOM should reflect this effective revision or date.</p>
Send Email to Suppliers	<p>Click this link to send email to suppliers.</p> <p>The email will contain one or two URLs. One URL sends the recipient back to this Maintain ECRs - Header: Header page. A second URL sends the recipient to the Change Request Detail page in PeopleSoft Engineering.</p>
View Email Log	<p>Click this link to access the Email Log page, where you can view the entire thread of messages sent regarding the ECR.</p>
Supplier Access List	<p>Click this link to access the Supplier Access List page, where you can view the list of suppliers that can have access to this ECR information.</p>

BOM/Routing Information tab

Field or Control	Description
BOM Chg (BOM change)	<p>Select this check box if the item that you selected will need a BOM introduction or will change as a result of the ECR. After the ECR is converted to an ECO, this field (along with the BOM Type and BOM Code fields) is used by the BOM transfer and mass maintenance functionality to transfer BOMs between PeopleSoft Engineering and Manufacturing. When you select BOM Chg, and you later run the engineering transfer or mass maintenance functions, the system assumes that a BOM is to be transferred or changed.</p> <p>If you select this check box, the BOM Type and BOM Code fields are available for selection.</p> <p>If you deselect this check box, the BOM Type and BOM Code fields are unavailable for selection, and <i>Production</i> appears by default as the BOM type.</p>
BOM Type	<p>Select a type. Values are:</p> <ul style="list-style-type: none"> • <i>Production</i>: Use production BOMs as the basis for manufacturing. • <i>Rework</i>: You can create rework BOMs when you have a standard rework process, where you need to include additional components. <p>As with production BOMs, you can define a primary rework BOM and up to 98 alternates, by creating BOM codes.</p>
Rtg Chg (routing change)	<p>Select this check box if the item that you selected will need a routing change as a result of the ECR. This field, along with the Routing Type and Routing Code fields, is used by the engineering transfer functionality to transfer routings between PeopleSoft Engineering and PeopleSoft Manufacturing. When you select Rtg Chg, and you later run the engineering transfer function, the system assumes that a routing is to be transferred or changed.</p> <p>If you select this check box, the Routing Type and Routing Code fields are available for selection.</p> <p>If you deselect this check box, the Routing Type and Routing Code fields are unavailable for selection, and <i>Production</i> appears by default as the routing type.</p>

Field or Control	Description
Routing Type	Select a type. Values are: <ul style="list-style-type: none"> • <i>Production</i>: Default routing type. Production routings can be used for standard manufacturing processes. • <i>Rework</i>: You can create rework routings when you have a standard rework process. Rework routings list routing steps that are commonly used, when reworking an assembly. • <i>Teardown</i>: The Teardown routing is used when you are breaking an assembly down into its component parts and returning the components back to inventory. Teardown routings can differ from the production routing, but can utilize any of the existing tasks or work centers defined for production.

If you enter a value in the **BOM Code** or **Routing Code** field, you are indicating that the codes associated with the item ID are impacted by the ECO. If either of those fields is left blank, you are indicating that all BOM or routing codes for the item ID are impacted. If the BOM Chg check box is selected, this indicates that one or more BOMs for the item is impacted by the ECR and the BOM Code field becomes available. Likewise, if the Rtg Chg check box is selected, this indicates that one or more routings for the item is impacted by the ECR, and the Routing Code field becomes available.

If the item's routing is a master (or reference) routing that is currently used by another item, then the **Mst Rtg** (master routing) display-only check box is selected.

Note: You can, at the business unit level, control whether ECR workflow is enabled. By selecting the appropriate check boxes, you control whether the system will send ECR workflow notification. If you have enabled workflow for ECR processing, then as you add ECRs, the system creates a workflow notification, with a status of *Pending*, for the designated ECR/ECO analyst. The ECR/ECO analyst can then choose to approve or reject the request. See also *PeopleSoft Engineering*, “Delivered Workflows for PeopleSoft Engineering”.

Related Links

"Header: Send Email to Suppliers - New Message Page" (PeopleSoft Manufacturing)

Maintain ECRs - Header: Reason/Action Page

Use the Maintain ECRs - Header: Reason/Action page (EG_ECR_REASONS) to (Optional) Associate reason and action codes with an ECR.

Navigation:

Engineering > Engineering Changes > Maintain ECRs > Header > Reason/Action

<i>Field or Control</i>	<i>Description</i>
Reason Code and Action Code	Select values for these fields. Reason codes reflect why the change is required. Action codes are based on engineering codes and represent the foreseen potential impact of the request. You can add unlimited reason and action codes.
Text	Enter additional reason and action codes.

Note: These reasons and actions apply to the overall ECR and are not item-specific.

Related Links

[Defining Engineering Codes](#)

Maintain ECRs - Header: Attachments Page

Use the Maintain ECRs - Header: Attachments page (EG_ECR_ATT) to attach multimedia objects, or files, that relate directly to the ECR.

Once attached, you can view these objects directly from this page.

Navigation:

Engineering > Engineering Changes > Maintain ECRs > Header > Attachments

<i>Field or Control</i>	<i>Description</i>
File Ext (file extension)	Select the type of media that you want to attach. You set up file extensions using the File Locations page.
Document ID and Description	Enter the file name and description of the multimedia file that you're attaching.

Note: Attachments have no integration or relation to the embedded document management functionality. They are most useful if you aren't using the document management functionality.

Chapter 10

Creating Engineering Change Orders (ECOs)

Understanding PeopleSoft Engineering ECOs

An engineering department needs to manage and document required item changes efficiently. You can use ECOs to manage the various activities required to implement multiple types of engineering changes. PeopleSoft Engineering ECOs enable you to manage and document item additions and BOM changes by giving you the ability to list items and associated information. You can also generate a report containing pertinent ECO information.

Related Links

[Examining the PeopleSoft Engineering Product Strategy](#)

Prerequisites

To use priority, reason, classification, and action codes when you maintain ECOs, you need to define the codes before you begin using the ECO-related pages. To have the system automatically generate your engineering change request (ECR) or ECO numbers, set up automatic numbering for ECRs and ECOs by using the Automatic Numbering page in the **Set Up Financials/Supply Chain > Common Definitions** navigation.

You need to define revisions prior to selecting them on the Items Affected or ECO Header pages. Or, if you are going to automatically increment revisions by using the BOM Mass Maintenance process, you need to define the revision scheme prior to running the BOM Mass Maintenance process.

You also need to create ECO approval types and their associated activity codes to employ engineering ECO types and ECO activities.

To attach mass maintenance codes to ECOs, it's simplest if you have already defined mass maintenance codes with the BOM Mass Maintenance Code component. You could, however, create the ECO first, then create the mass maintenance code, and, as a final step, update the ECO with the mass maintenance code.

If you plan to use the embedded document management system to access ECO and ECO item documents, you can define what function buttons are available on the ECO document management pages by using the Documentum Component Options page.

Related Links

"MFG BU Prdn Options Page" (PeopleSoft Manufacturing)
[Understanding Document Management in PeopleSoft Engineering](#)

Creating and Maintaining ECOs

With PeopleSoft Engineering, you can efficiently create and maintain ECOs, including the definition of top-level information and items affected, as well as workflow data.

This topic lists common elements and discusses how to create and maintain ECOs.

Pages Used to Create and Maintain ECOs

Page Name	Definition Name	Usage
<u>Maintain ECOs - Header: Header Page</u>	EG_ECO_HEADER	Maintain ECO header information including items affected data. For quick entry, this page contains all the fields required on the ECO.
Maintain ECOs -Header: Email Log Page	EG_SS_EMAIL_LOG	View the thread of messages for a particular ECO. If this page is blank, no emails have been sent regarding this ECO. <u>Maintain ECOs - Header: Header Page</u>
Maintain ECOs - Supplier Access List Page	EG_SS_ECOVND_LST	View a list of suppliers that can have access to this ECO. <u>Maintain ECOs - Header: Header Page</u>
<u>Maintain ECOs - Header: Reason/Action Page</u>	EG_ECO_REASONS	(Optional) Associate reason and action codes with an ECO.
Maintain ECOs - Header: Documents	EG_ECO_DC	Associate, access, and manage pertinent ECO documents in the embedded document management system.
<u>Maintain ECOs - Header - Attachments Page</u>	EG_ECO_ATT	Attach multimedia objects, or files, that relate directly to the ECO. Once attached, you can view these objects directly from this page.

Page Name	Definition Name	Usage
Maintain ECOs - Items Affected: Detail Page	EG_ECO_ASSY	<ul style="list-style-type: none"> Associate one or more new, changing, or impacted items to a specific ECO. Optionally add or edit revisions and EBOMs. Select an ECO default mass maintenance code. Define automatic revisions to be generated for parent assemblies.
Maintain ECOs - Items Affected: Reason/Action	EG_ECO_ASSY_RES	(Optional) Associate reason and action codes for each item affected by an ECO.
Maintain ECOs - Items Affected: Document	EG_ECO_ASSY_DC	Associate, access, and manage pertinent item documents in the embedded document management system.
Maintain ECOs - Items Affected: Attachments	EG_ECO_ASSY_ATT	Attach multimedia objects, or files, that relate to the affected item. Once attached, you can view these objects directly from this page.
<u>Maintain ECOs - Items Affected: Status Page</u>	EG_ECO_ASSY_SCHD	Review the engineering BOM and production release status for each item affected, as well as activate an ECO pending alert button on several related pages.
<u>Maintain ECOs - Workflow Page</u>	EG_ECO_ROUTINGS	Assign the ECO type, submit the ECO to workflow, define the ECO requestor, and associate related ECRs and ECOs.
<u>Maintain ECOs - Approval Page</u>	EG_IC_ECO_REVIEW	Enter ECO approval information data and approve individual ECO workflow steps.
ECO Report	EG_ECO_REPORT	Generate an ECO report (EGS1000).
Approve/Convert ECRs	EG_ECR_APPROVAL	Change the status of an ECR, and optionally convert ECRs into ECOs.

Common Elements Used in This Section

Field or Control	Description
Status	<p>Represents the overall state of the ECO. Values include: <i>Pending, Canceled, Denied, Approved, and Released.</i></p> <p>You can change the overall status of the ECO with the Approve ECOs page.</p> <p>When you add an ECO, the system sets the status to <i>Pending.</i></p> <hr/> <p>Note: You must set this status to <i>Approved</i> before engineering BOMs can be transferred to manufacturing.</p> <hr/>
Type	<p>Select the type of change. Values are:</p> <ul style="list-style-type: none"> • <i>Chg</i> (change): The ECO makes a change to an existing item. • <i>New</i>: The ECO introduces a new item. • <i>Imp</i> (impacts): A changed or new item impacts this item (for example, a new or changed component item has an effect on the assembly item to which it reports). <p>You can run the where-used inquiry by clicking the Search button, to determine the assembly items impacted by the new or changed component.</p>

Field or Control	Description
	<p>Click the View Related Links button in the Item ID column to access any one of these pages:</p> <ul style="list-style-type: none"> • Add Rev: Click this link to access the Revision Maintenance page to add a new revision for an item that has no revisions. • Edit Rev: Click this link to access the REV Maintenance page to edit an existing revision for the item. • Add Engineering BOM: Click this link to access the EBOM Maintenance page to add a new engineering BOM for the item. • Edit Engineering BOM: Click this link to access the EBOM Maintenance page to edit an existing engineering BOM for the item. • Add Manufacturing BOM: Click this link to access the BOM Summary page to add a new manufacturing BOM for the item. • Edit Manufacturing BOM: Click this link to access the BOM Summary page to edit an existing manufacturing BOM for the item. • Add Engineering Rtg: Click this link to access the Engineering Routing Summary page to add a new engineering routing for the item. • Edit Engineering Rtg: Click this link to access the Engineering Routing Summary page to edit an existing engineering routing for the item. • Add Manufacturing Rtg: Click this link to access the Routing Summary page to add a new manufacturing routing for the item. • Edit Manufacturing Rtg: Click this link to access the Routing Summary page to edit an existing manufacturing routing for the item. • Item Search: Click this link to access the Item Search Criteria page and select a different item. • Master Rtg Where Used: Click this link to access the Master Routing Where Used Inquiry page to display master routing where used information. <p>If the item's routing is a master (or reference) routing currently being used by another item, this link is available.</p>

Field or Control	Description
BOM Type	<p>Select a type. Values are:</p> <ul style="list-style-type: none"> • <i>Production</i>: Use production BOMs as the basis for manufacturing assemblies. • <i>Rework</i>: You can create rework BOMs when you have a standard rework process, where you need to include additional components. <p>As with production BOMs, you can define a primary rework BOM and up to 98 alternates, by creating BOM codes.</p>
Routing Type	<p>Select a type. Values are:</p> <ul style="list-style-type: none"> • <i>Production</i>: Default routing type. <p>Production routings can be used for standard manufacturing processes.</p> <ul style="list-style-type: none"> • <i>Rework</i>: You can create rework routings when you have a standard rework process. <p>Rework routings list routing steps that are commonly used, when reworking an assembly.</p> <ul style="list-style-type: none"> • <i>Teardown</i>: The Teardown routing is used when you are breaking an assembly down into its component parts and returning the components back to inventory. <p>Teardown routings can differ from the production routing, but can utilize any of the existing tasks or work centers defined for production.</p>
	<p>Click the Attachments button to launch the multimedia object attached to the ECO.</p>

Maintain ECOs - Header: Header Page

Use the Maintain ECOs - Header: Header page (EG_ECO_HEADER) to maintain ECO header information including items affected data.

For quick entry, this page contains all the fields required on the ECO.

Navigation:

Engineering > Engineering Changes > Maintain ECOs > Header > Header

This example illustrates the fields and controls on the Maintain ECOs - Header: Header page. You can find definitions for the fields and controls later on this page.

Field or Control	Description
ECO Number	Displays <i>NEXT</i> , if this is a new ECO and you are using automatic numbering.
Status	Displays <i>Pending</i> , when you add an ECR. This status represents the overall state of the ECR. Other statuses include <i>Canceled</i> , <i>Denied</i> , <i>Approved</i> , and <i>Converted</i> .
Description, Comments, Priority Code, and Department	Displays default values from the ECR, if the ECO was converted from an ECR. Otherwise, you must enter the information.
Not Accessible by Suppliers	Select to block access to a specific ECO. Therefore, even if suppliers have been granted access with the BOM Access by Supplier page in PeopleSoft Manufacturing, you can deny them access to a specific ECO.
Department	Select or change the department responsible for the ECO. Departments are defined in the PeopleSoft General Ledger business unit.
Schd Date (scheduled release date)	Enter a date to identify when the ECO is scheduled to be released to manufacturing. This date does not represent the scheduled effectivity dates or revisions for the assemblies being changed. When you run the BOM Mass Maintenance process to automatically create new revisions, the scheduled release date is the effective date of any created revisions.
Orig Date (original release date)	Displays the original ECO scheduled date. This field is display only; the system sets it the first time that you save the ECO.

<i>Field or Control</i>	<i>Description</i>
Where Used	Click this link to access the Select Assemblies by Items Where Used page, where you can find the item information that you need to populate the Items Affected region of the page.

Items Affected

<i>Field or Control</i>	<i>Description</i>
Type	Select the type of change.
Item ID	<p>Select the changed, impacted, or new item ID. You can specify Make, Buy, Floor Stock, or Expensed items; however, you cannot specify PeopleSoft Supply Planning items.</p> <p>If the request is for a new item ID that doesn't yet exist on the Item Definition page, enter a placeholder item here.</p> <hr/> <p>Note: If you list an impacted item, you must also list the corresponding new or changed item that impacts it. You can associate multiple items with a single ECO.</p>
From Rev (from item revision)	<p>Enter the originating revision on which you are basing the change. You can add multiple ECOs that affect the same item revision.</p> <hr/> <p>Note: The from and effective revisions need to be defined with the Revision Maintenance page prior to using them here.</p>
Eff Rev (effective item revision)	<p>Select the new revision that is in effect after the change is implemented. If the item ID is revision-controlled, you can access this field; otherwise, it is display-only. You must have already defined this revision in the system, and the effective item revision can't have a start date that is prior to the From item revision. After you enter the effective revision, the system displays the start date of the revision in the Eff Date (effective date) field.</p> <p>If the item is not revision-controlled, you can enter the effective date for the change. Enter the new effectivity date for which the changes are in effect.</p> <p>Both Eff Rev and Eff Date fields are for informational purposes only. If you make changes to the BOM, the component ID effective and obsolete dates and revisions on the BOM should reflect this effective revision or date.</p>

Field or Control	Description
Send Email to Suppliers	Click to send email to suppliers, if you have enabled external access to suppliers for PeopleSoft Engineering information. The email contains one or two URLs. One URL sends the recipient back to the Header: Header page. A second URL sends the recipient to the Change Order Detail page.
View Email Log	Click to access the Email Log page, where you can view the entire thread of messages sent regarding the ECO.
Supplier Access List	Click to access the Supplier Access List page, where you can view the list of suppliers that can have access to this ECO information.

BOM/Routing Information tab

Select the BOM/Routing Information tab on the Maintain ECOs - Header: Header page.

This example illustrates the fields and controls on the BOM/Routing Information for the ECO. You can find definitions for the fields and controls later on this page.

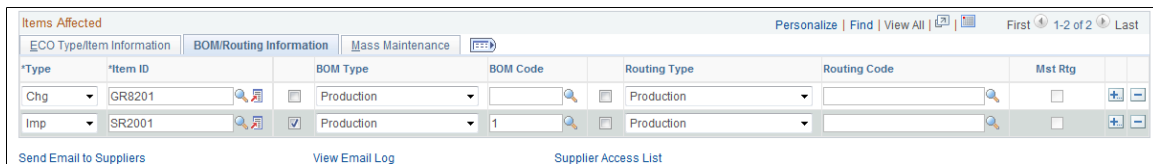

Field or Control	Description
BOM Chg (BOM change)	Select if the item that you selected will need a BOM change as a result of the ECO. This field, along with the BOM Type and BOM Code fields, is used by the BOM transfer and mass maintenance functionality to transfer BOMs between PeopleSoft Engineering and PeopleSoft Manufacturing. When you select BOM Chg and you later run the engineering transfer or mass maintenance functions, the system assumes that a BOM is to be transferred or changed. If you deselect this check box, the BOM Type and BOM Code fields are unavailable for selection, and <i>Production</i> appears by default as the BOM type.
BOM Type and BOM Code	Select values for these fields.

Field or Control	Description
BOM Type	Select a value for this field. Values are <i>Production</i> (default) and <i>Rework</i> .
Rtg Chg (routing change)	Select if the item that you selected will need a routing change as a result of the ECO. This field, along with the Routing Type and Routing Code fields, is used by the engineering transfer functionality to transfer routings between PeopleSoft Engineering and PeopleSoft Manufacturing. When you select Rtg Chg , and you later run the engineering transfer function, the system assumes that a routing is to be transferred or changed.
Routing Type	Select a value for this field. Values are <i>Production</i> (default), <i>Rework</i> , and <i>Tear-down</i> .
Routing Code	Select a value for the routing.
Mst Rtg (master routing)	Selected if the item's routing is a master (or reference) routing that is currently used by another item; this check box is display-only.

If you enter a value in the **BOM Code** or **Routing Code** field, you are indicating that the codes associated with the item ID are impacted by the ECO. If either field is left blank, you are indicating that all BOM and routing codes for the item ID are impacted. If the **BOM Chg** check box is selected, this indicates that one or more BOMs for the item is impacted by the ECO, and the **BOM Code** field becomes available. Likewise, if the **Rtg Chg** check box is selected, this indicates that one or more routings for the item is impacted by the ECO, and the **Routing Code** field becomes available.

Indicating BOM and routing changes on the ECO has this impact in PeopleSoft Engineering:

- Engineering transfers use this information to transfer and validate specified BOMs or routings to and from PeopleSoft Engineering.
- The mass maintenance code is applied to all BOM codes specified when run (when mass maintenance is specified for the item ID).
- If you run the Mass Maintenance process combined with the auto revision feature, new revisions are created for the BOM items.

In addition, new BOM components are introduced to the BOMs effective for the new automatic revisions.

Mass Maintenance tab

Select the Mass Maintenance tab on the Maintain ECOs - Header: Header page.

This example illustrates the fields and controls on the Mass Maintenance information for the ECO. You can find definitions for the fields and controls later on this page.

Items Affected								Personalize Find View All		First	1-3 of 3	Last
ECO Type/Item Information		BOM/Routing Information		Mass Maintenance								
*Type	*Item ID		Mass Maint Code	Status	Description	Rev Up	Rev Created					
Chg	GR8002		<input type="text"/>	<input type="checkbox"/>		<input type="checkbox"/>	<input type="checkbox"/>					
Imp	SR2001		<input type="text"/>	<input type="checkbox"/>		<input type="checkbox"/>	<input type="checkbox"/>					
New	GR8003		<input type="text"/>	<input type="checkbox"/>		<input type="checkbox"/>	<input type="checkbox"/>					

When an ECO is impacting several BOMs (for example phasing out a component and adding a revised component), you can implement the actual BOM changes by listing the impacted assemblies on the ECO and associating a Mass Maintenance Code (MMC). This code specifies the details of the change. This tab enables you to associate the MMC with the impacted assemblies. After saving this information on the ECO, you can use Mass Maintenance by ECO to implement changes to the BOMs.

Field or Control	Description
Mass Maint Code (mass maintenance code)	<p>Select the code that will be the ECO default MMC. You can then use this default or select a different MMC for the ECO-affected items displayed. The MMC status appears as a display-only field.</p> <hr/> <p>Note: You can specify an MMC for an item only if you select the BOM Chg check box. You can change the MMC for an item at any time, except when the status for the MMC is <i>Success</i>.</p>
	<p>Click the View Related Links button in the Mass Maint Code column to access one of these links:</p> <p>Add Mass Maintenance Code: Click this link to access the BOM Mass Maintenance page to add a new mass maintenance code.</p> <p>Update Mass Maintenance Code: Click this link to access the BOM Mass Maintenance page to update an existing mass maintenance code.</p>

Field or Control	Description
<p>Rev Up (automatic revisions)</p>	<p>Selected by default if the associated MMC is set to use automatic revision and if the associated affected item is both revision-controlled and set to automatic revisions.</p> <p>You can select this check box to manually automatically revision the item, if the item is set up to automatically increment the revision and the MMC is blank or the MMC used does not specify automatic revision. If you decide to automatically increment the revision for the item, then select this check box, and run the BOM Mass Maintenance by ECO process for the ECO in order to complete the automatic revisioning for the item.</p> <p>You can also use this check box to automatically increment the revisions of higher-level assemblies. If you set Type to <i>Imp</i> (impacted), and the item is defined to use revision-controlled and automatic revisions, you can select Rev Up to indicate that this item's BOM is to be automatically incremented to the next revision when the mass maintenance by ECO process is run.</p> <hr/> <p>Note: The Rev Up feature cannot be run with the mass maintenance by MMC process nor can it be run within PeopleSoft Manufacturing.</p>
	<p>Click the Look Up Mass Maintenance Code button to find additional parent assemblies in which to automatically create revisions.</p>
<p>Rev Created (automatic revision created)</p>	<p>This check box indicates that the BOM Mass Maintenance by ECO process has been run for this ECO and the revision has been successfully created. This field is always display-only.</p>

Related Links

"Header: Send Email to Suppliers - New Message Page" (PeopleSoft Manufacturing)
[Understanding Mass BOM Changes](#)

Maintain ECOs - Header: Reason/Action Page

Use the Maintain ECOs - Header: Reason/Action page (EG_ECO_REASONS) to (Optional) Associate reason and action codes with an ECO.

Navigation:

Engineering > Engineering Changes > Maintain ECOs > Header > Reason/Action

This example illustrates the fields and controls on the Maintain ECOs - Header: Reason/Action page. You can find definitions for the fields and controls later on this page.

Field or Control	Description
Reason Code and Action Code	Select reason codes and action codes. Reason codes reflect why a change is required. Action codes are based on engineering codes and represent the foreseen potential impact of the request. You can add unlimited reason and action codes.
Text	Enter additional reason and action codes. <hr/> Note: These reasons and actions apply to the overall ECO and are not item-specific. <hr/>
Ref ECRs (reference ECRs) and Ref ECOs (reference ECOs)	Link an ECO to one or more existing ECRs or ECOs. If the ECO was originally converted from an ECR, the system automatically populates the Ref ECRs field with the original ECR from which it was converted.

Related Links

[Defining Engineering Codes](#)

Maintain ECOs - Header - Attachments Page

Use the Maintain ECOs - Header - Attachments page (EG_ECO_ATT) to attach multimedia objects, or files, that relate directly to the ECO.

Once attached, you can view these objects directly from this page.

Navigation:

Engineering > Engineering Changes > Maintain ECOs > Header > Attachments

<i>Field or Control</i>	<i>Description</i>
File Ext (file extension)	Select the type of media that you want to attach. You set up file extensions by using the File Locations page.
Document ID and Description	Enter the file name and description of the multimedia file that you're attaching.

Note: Attachments have no integration or relation to the embedded document management functionality. They are most useful if you aren't using the document management functionality.

Maintain ECOs - Items Affected: Status Page

Use the Maintain ECOs - Items Affected: Status page (EG_ECO_ASSY_SCHD) to review the engineering BOM and production release status for each item affected, as well as activate an ECO pending alert button on several related pages.

Navigation:

Engineering > Engineering Changes > Maintain ECOs > Items Affected > Status

<i>Field or Control</i>	<i>Description</i>
Engineering BOM Exists	In the Engineering BOM Status group box, this check box is display-only. The system selects it if an engineering BOM currently exists for the item ID and BOM code combination.
User ID and Copy Date/Time	Displays the user ID and the date and time of copy, if the BOM was copied into engineering. If you specified a BOM code for this item's BOM, then the copy information refers to that particular BOM code. If the BOM code is blank, then the copy information refers to the last BOM code that was copied to engineering.
Engineering Routing Exists	In the Engineering Routing Status group box, this check box is display-only. The system selects it if an engineering routing currently exists for the item ID and routing code combination.
User ID and Copy Date/Time	Displays the user ID and the date and time of copy, if the routing was copied into engineering. If you specified a routing code for this item's routing, then the copy information refers to that particular routing code. If the routing code is blank, then the copy information refers to the last routing code that was copied to engineering.

Field or Control	Description
Release Date	<p>Enter the release date. The release date is the scheduled release date of the item ID and BOM and routing changes to production, by using the Approve ECO page, the engineering transfer process, or the BOM mass maintenance process.</p> <hr/> <p>Note: Today's date initially appears by default as the release date. It can be modified until the BOM, routing, or both are released by using the Engineering Transfers process, at which time the Release Date field is updated with the actual transfer date and becomes unavailable for input.</p> <hr/>
Release Status	<p>Select the production release status. Values are:</p> <ul style="list-style-type: none"> • <i>Canceled:</i> The new or changed item was never implemented, and revised items are canceled. • <i>Pending:</i> The new or change item is in the approval process and is pending release. • <i>Released:</i> The new or changed item is released from the responsible ECO/engineering department and has been implemented. <p>If the BOM or Rtg check box is selected for the item, the system sets the status to <i>Released</i>, when you transfer an EBOM or engineering routing to manufacturing by using the Engineering Transfers pages. In this case, you can't set the status to <i>Released</i> manually. If the BOM and Rtg check boxes aren't selected, you can enter the release status.</p>
Orig Date (original date)	Displays the original release date for the ECO item.
ECO Pending Alert	Select to make pending ECOs visible within EBOM, MBOM, item revision, and routing maintenance pages.
	When you select the ECO Pending Alert check box, the ECO button appears on these pages when information (such as item revisions) is maintained for the item with an ECO against it. When you click the ECO button, you can display the pending ECO, effective revision for the change, and associated text describing the change. Once the ECO is released, the ECO button no longer appears.



Maintain ECOs - Workflow Page

Use the Maintain ECOs - Workflow page (EG_ECO_ROUTINGS) to assign the ECO type, submit the ECO to workflow, define the ECO requestor, and associate related ECRs and ECOs.

Navigation:

Engineering > Engineering Changes > Maintain ECOs > Workflow

This example illustrates the fields and controls on the Maintain ECOs - Workflow page. You can find definitions for the fields and controls later on this page.

Header			Items Affected			Workflow		
Unit US008		ECO Number EC00000005		Status Pending				
Workflow Status								
Submit WF No						Submit		
ECO Type 100		Standard ECO Workflow						
ECO Activity								
Origination								
*Requestor MDRAKE				<input type="checkbox"/> Converted from ECR				
Created on 06/30/2014 5:24AM								
Approval Process			Personalize Find  			First 1 of 1 Last		
*Name	*Role	Action Taken	Date	Comments				
						+ -		

Field or Control	Description
ECO Type (ECO approval type)	<p>You can optionally associate the ECO with an ECO type. When you specify an ECO type, the ECO Activity field displays the first sequence and ECO activity, as defined within that ECO type. ECO approval types enable you to associate the ECO with a sequential routing of activities through which the ECO must move and which must be promoted prior to its completion. To promote or demote ECO activities, use the Promote ECO Activity page. You can use this feature independently of workflow.</p> <p>If workflow has been enabled with the Engineering Options page, and the ECO type has a business process and approval rule set associated with it, then the ECO can be routed through steps defined within the approval rule set so that role users can approve, deny, or recycle an ECO. When the ECO is routed within workflow, the current activity appears. These role users access ECO approval processing by way of the worklist.</p> <p>Note: You can't change the ECO Type field once the ECO has been submitted to workflow.</p>

Field or Control	Description
Submit	If workflow has been enabled with the Engineering Options page, and the ECO type has a business process and approval rule set associated with it, you can click this button (which also saves the ECO) to initiate workflow approval processing as defined for the ECO type that you specified. Once workflow has been initiated, the system displays <i>Submitted</i> in the Submit WF (submit workflow) field, and the field is unavailable. If the workflow has been submitted, a list of users and related roles to which the workflow is submitted appears in the Approval Process scroll area. The list of users is originally derived from the ECO type and approval rule set associated with it. Once created, this list can be modified to include or exclude additional users for this particular ECO. As long as you don't click the Submit button, workflow won't be initiated. If workflow hasn't been enabled, this field is unavailable for selection.
Requestor	Enter the name of the requestor in the Origination group box. The value of this field appears by default from an associated ECR if converting an ECR created the ECO.
Converted from ECR and Created on	If the ECO was created from a converted ECR, then this display-only check box is selected and the created on time stamp displays the time that the ECR was converted to an ECO. If the ECO wasn't converted from an ECR, then the created on time stamp displays the current time by default and is display only.

After an ECO is submitted for workflow, the list of approvers is determined and displayed in the **Approval Process** group box. The person who submits the ECO for workflow processing is listed as the originator. You can add or delete approvers from the workflow Approval Process as long as the person has not yet approved the workflow entry for the ECO. Once the approver has taken an action, all the fields are unavailable for selection. When a new approver is added, the step for the new approver is set at the next step by the system. For example, if AMS2 is at step 2, and the **Add** button is clicked, the new approver is added with step 3. This means that the new approver is notified when all approvers at step 2 have approved the ECO.

When a workflow approver approves an ECO, the approver in the next step is notified with an email or worklist entry. The method by which each approver is notified depends on the workflow rules set up using the Workflow System Rules page. If an approver denies or recycles an ECO, then the approver in the previous step is notified, and the action taken is reset to *Pending*.

See also *PeopleSoft Engineering*, “Delivered Workflows for PeopleSoft Engineering”.

Related Links

[Setting Up PeopleSoft Engineering Tables](#)

Maintain ECOs - Approval Page

Use the Maintain ECOs - Approval page (EG_IC_ECO_REVIEW) to enter ECO approval information data and approve individual ECO workflow steps.

Navigation:

Engineering > Engineering Changes > Maintain ECOs > Approval

For multiple step approval, the Maintain ECOs - Approval page is visible only if all of these statements are true:

- The current user is the current approver in the list of approvers, as displayed in the **Approval Process** group box on the Maintain ECOs - Workflow page.
- The action is not *Approved*.
- All approvers at the previous steps have already approved the prior ECO workflow approval status.

For single-step approval, the Approval page is visible if the current user is in the list of approvers and the approval action is not set to *Approved*.

You need to grant privileges to ECO approvers for these objects:

- On the Permission Lists - Pages page, you need to add WORKLIST.

The approver uses this to access ECOs that need to be reviewed.

- On the Permission Lists - Component Interface page, you need to add WORKLISTENTRY.

This component interface is used to mark an ECO as worked after the ECO is reviewed or approved.

Related Links

[Setting Engineering Options](#)

Chapter 11

Processing ECRs and ECOs

Understanding ECR and ECO Processing

The complexity of your change processes determines which, if any, of these process steps you need to take. Processing and transferring steps for PeopleSoft Engineering include:

- Approving ECRs and converting them to ECOs.
- Approving and promoting ECOs through their sequence of ECO activities.
- Approving ECOs.
- Displaying approved, denied, and recycled ECO activity.
- Transferring engineering bill of materials (EBOM) to production by way of ECOs.
- Auditing EBOM release and copy.

Note: All of these steps are optional, except for approving ECOs, which is required when you release EBOMs back to production.

ECR and ECO approval processing are integrated with the Workflow Virtual Approver. This integration enables you to define multistep approval processing, including approve, deny, and recycle functionality.

Examples of ECR and ECO Workflow Processing

The following diagram illustrates the ECR workflow approval process from ECR creation, workflow notification, approval, and ECO creation:

Workflow process for approving ECRs and converting them to ECOs

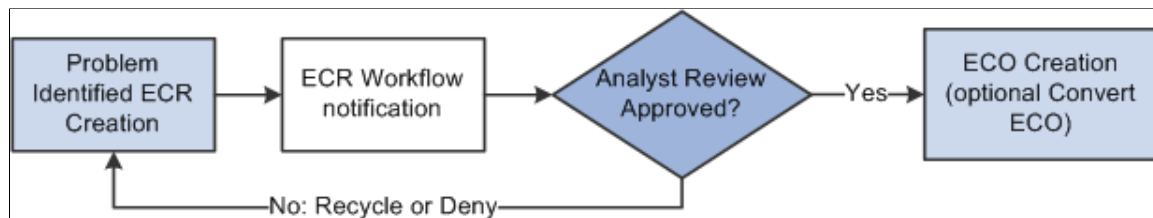

The following diagram illustrates the ECO workflow approval process for the four user-defined ECO activities and the user-defined business process and approval rule set:

ECO workflow processing

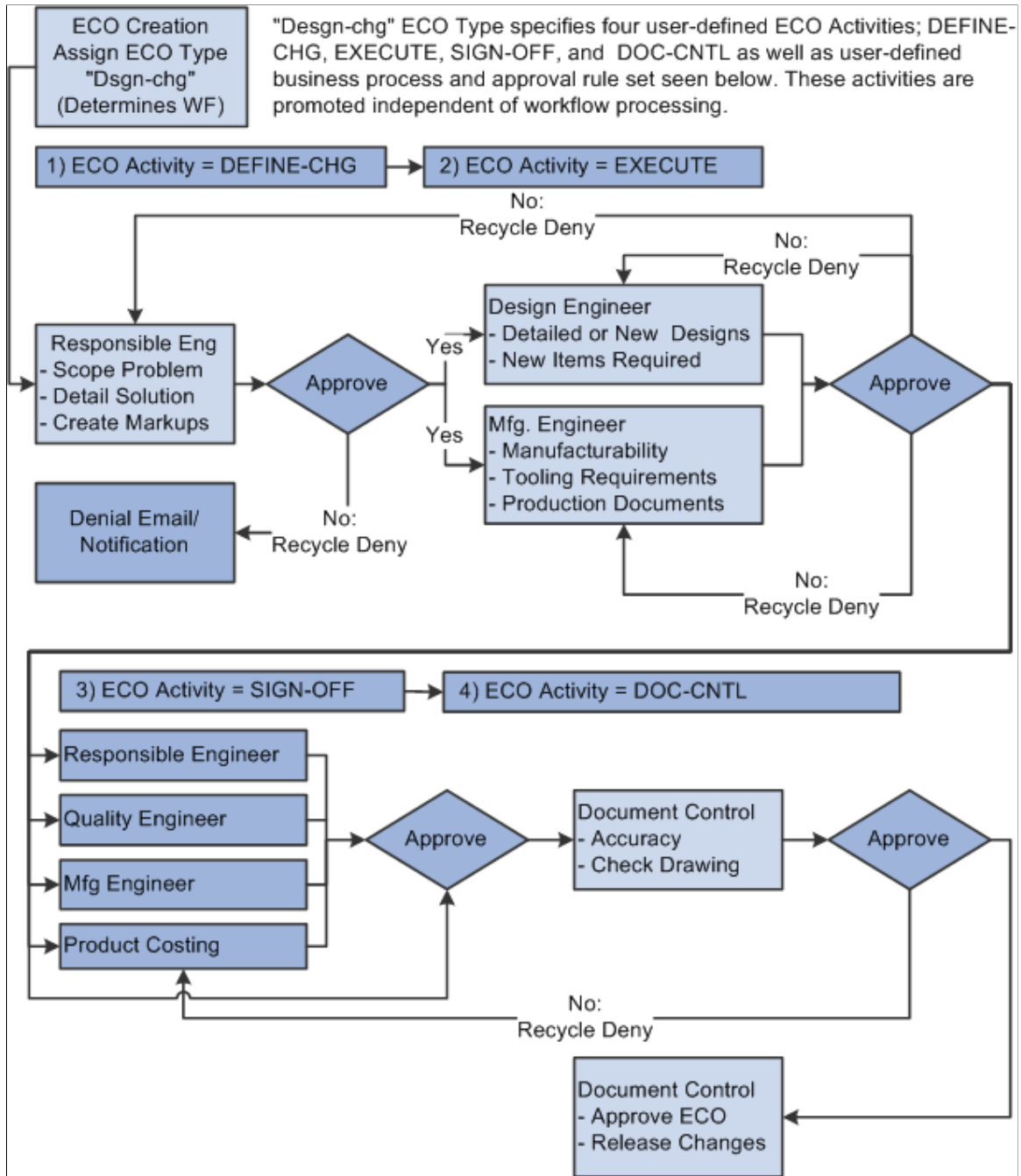

See the product documentation for *PeopleSoft Engineering*, “Delivered Workflows for PeopleSoft Engineering”.

Prerequisites

If you intend to generate ECO numbers automatically, you must set up automatic numbering for ECOs before converting ECRs to ECOs, by using the Automatic Numbering page.

If you plan to use PeopleSoft Workflow with ECRs or ECOs, you must define the PeopleSoft Workflow business processes and approval rules, as well as ECO activities and ECO approval types, before you process the ECOs.

Approving and Converting ECRs

PeopleSoft Engineering enables you to efficiently track and manage engineering change processes.

This topic discusses how to approve and convert ECRs.

Page Used to Approve and Convert ECRs

<i>Page Name</i>	<i>Definition Name</i>	<i>Usage</i>
<u>Approve/Convert ECRs Page</u>	EG_ECR_APPROVAL	Change the status of ECRs, and optionally convert ECRs into ECOs.

Approve/Convert ECRs Page

Use the Approve/Convert ECRs page (EG_ECR_APPROVAL) to change the status of ECRs, and optionally convert ECRs into ECOs.

Navigation:

Engineering > Engineering Changes > Approve ECRs/Create ECOs > Approve/Convert ECRs

This example illustrates the fields and controls on the Approve/Convert ECRs page. You can find definitions for the fields and controls later on this page.

The screenshot displays the 'Approve / Convert ECRs' page interface. At the top, there is a header bar with the page title. Below this, the 'Unit' is set to 'US008' and the 'ECR Number' is 'ECR0000005'. The main content area includes a 'Description' field with the text 'Wheel Spokes Upgrade' and a 'Comments' text area containing 'Modify wheel spokes used on Mountain Bike'. Below the comments, the 'Priority Code' is 'MED' (Medium) and the '*Status' is 'Pending'. A 'Convert to ECO' button is visible next to the status dropdown. To the right, there is a '*ECO NEXT' button. At the bottom, there is a 'Deny/Cancel Reason' text area.

Field or Control	Description
Status	Select an ECR status. Values are: <ul style="list-style-type: none"> • <i>Approved</i>: Activates the Convert to ECO button. • <i>Converted</i>: Set automatically by the system when you convert an ECR. • <i>Denied</i> or <i>Canceled</i>: Activates the Deny/Cancel Reason field. • <i>Pending</i>: No action occurs.

To approve an ECR:

1. Select *Approved* as the status.
2. Click the **Save** button.

Approving an ECR does not convert the ECR to an ECO.

Upon save, if you have PeopleSoft Workflow enabled, the ECO is sent to a list of defined roles for approval.

To convert an ECR to an ECO:

1. Select *Approved* as the status.
2. Click the **Convert to ECO** button.
3. Enter an ECO number.

If you have set up automatic numbering for ECOs, then the system automatically generates an ECO number when you save the information.

4. Click the **Save** button.

The ECO is not created until you click this button.

Additional Information

When you convert an ECR to an ECO, the system:

- Enters by default the ECR header information in the ECO header.
- Reflects the converted ECR reference number on the ECO, and marks the ECO as converted from an ECR.
- Copies by default the ECR reason codes and action codes to the ECO.
- Reflects the ECR *assemblies affected* data in the ECO.
- Copies the ECR header and assembly document associations to the ECO.

- Sets the status of the new ECO to *Pending*.

After you convert an ECR to an ECO, the originating ECR remains unaffected except that the system changes its ECR status to *Converted*. At this point, you can modify the ECO without any effect on the original ECR. Once you convert an ECR, you can no longer change its status.

Note: If ECR workflow is enabled, you can define workflow processing and approval rules to route the ECR to the appropriate role.

Related Links

[Maintain ECRs - Header: Header Page](#)

Promoting ECO Activities

ECO activities represent phases or milestones associated with an ECO. You can promote the activities independently or in coordination with workflow approval processing. As an example, if you are not using workflow, you can still set up the static list and promote or demote the ECO. The system ensures that if activities exist, they all must be promoted before the ECO can be approved. If you are using both workflow and activities, the system routes the ECO workflow to the various steps and role users based on workflow-defined rules.

While you probably want to use one method or another, you could also independently continue to promote the ECO through the static list of activities.

This topic discusses how to promote ECO activities.

Page Used to Promote ECO Activities

<i>Page Name</i>	<i>Definition Name</i>	<i>Usage</i>
Promote ECO Activity Page	EG_ECO_UP_ACTY	Promote or demote ECOs through their life cycle of ECO activities if you are using ECO approval types that have activities defined.

See also the documentation *PeopleSoft Engineering*, “Delivered Workflows for PeopleSoft Engineering”.

Promote ECO Activity Page

Use the Promote ECO Activity page (EG_ECO_UP_ACTY) to promote or demote ECOs through their life cycle of ECO activities if you are using ECO approval types that have activities defined.

Navigation:

Engineering > Engineering Changes > Promote ECO Activity > Promote ECO Activity

Field or Control	Description
Promote	Click to change the current status from <i>Pending</i> to <i>Approved</i> and to advance the ECO to the next activity within the sequence of ECO activities listed. Once all ECO activities have been approved and promoted, you can approve the ECO itself.
Demote	Click to change the current activity to the previous activity listed, thus demoting the ECO. When you demote an ECO, the system automatically resets the status of the activity being demoted to <i>Pending</i> .

Note: Promoting and demoting ECOs has no effect on PeopleSoft Workflow approval processing.

Approving ECOs

You must approve an ECO before transferring EBOM and engineering routing changes to production by using the Engineering Transfer pages.

This topic discusses how to approve ECOs.

Page Used to Approve ECOs

Page Name	Definition Name	Usage
Approve ECO Page	EG_ECO_APPROVAL	Change the status of an ECO, including approving an ECO.

Approve ECO Page

Use the Approve ECO page (EG_ECO_APPROVAL) to change the status of an ECO, including approving an ECO.

Navigation:

Engineering > Engineering Changes > Approve ECOs > Approve ECO

This example illustrates the fields and controls on the Approve ECO page. You can find definitions for the fields and controls later on this page.

The screenshot shows the 'Approve ECO' page with the following details:

- Unit:** US008
- ECO Number:** ECO0000005
- Send Email to Suppliers:** (button)
- Description:** Defect in Chain, Sugishita
- Priority Code:** HIGH (High)
- ECO Type:** 100 (Standard ECO Workflow)
- Comments:** Chain, Sugishita (GR8002) linkage defect causes excessive wear on related gear subassemblies (i.e. SR2001) due to improper spacing between links (.1 mm versus .12 mm). Suggest substitute GR8002-B for
- Status:** Pending
- Notes:** (empty text area)

Below the form is an 'ECO Activities' table with the following structure:

Sequence	ECO Activity	Description
0		

When you enter a new ECO, the system automatically sets the ECO status to *Pending*. Once you approve the ECO for release, or if the ECO is denied or canceled, you can use this page to change the status accordingly.

Once the ECO is approved and all BOMs and routings are transferred to production, the system automatically sets the ECO status to *Released*.

Field or Control	Description
Status	Select a status. Values are: <i>Approved</i> , <i>Canceled</i> , <i>Denied</i> , <i>Pending</i> , and <i>Released</i> . If no items on the ECO require that BOMs be transferred with engineering transfers, then you can set the status of the ECO to <i>Released</i> on this page.

To release ECOs that contain items, including BOM or routing changes in addition to items without BOM or routing changes (such as purchase item changes):

1. Set the ECO status to *Approved* on this page.

This setting is required to release BOM and routing changes to production.

2. Run the Engineering Transfers process to transfer all BOM and routing changes to production.

If the ECO that you are releasing is for items without BOM or routing changes, you do not need to perform Step 3.

3. Set the ECO status to *Released*.

This setting enables you to automatically release in one step all items that have no BOM or routing changes.

Note: Approving an ECO has no effect on PeopleSoft Workflow approval processing.

<i>Field or Control</i>	<i>Description</i>
Send Email to Suppliers	<p>Click to send email to suppliers.</p> <p>The email contains one or two URLs. One URL sends the recipient to the Maintain ECOs - Header page in PeopleSoft Engineering. A second URL sends the recipient to the Change Order Detail page.</p>

Related Links

"Header: Send Email to Suppliers - New Message Page" (PeopleSoft Manufacturing)

Viewing Approved, Denied, and Recycled ECO Activities

This topic discusses how to view approved, denied, and recycled ECO activities.

Page Used to View Approved, Denied, and Recycled ECO Activities

<i>Page Name</i>	<i>Definition Name</i>	<i>Usage</i>
<u>ECO Workflow Approval Page</u>	EG_ECO_OPR_APPR	If you are using ECO approval types and workflow approval processing, you can use this page to view approved, denied, or recycled ECO activity by user ID.

ECO Workflow Approval Page

Use the ECO Workflow Approval page (EG_ECO_OPR_APPR) to if you are using ECO approval types and workflow approval processing, you can use this page to view approved, denied, or recycled ECO activity by user ID.

Navigation:

Engineering > Engineering Changes > Review ECO Information > ECO Workflow Approval > ECO Workflow Approval

You can view approved, denied, or recycled ECO activity by user ID. When ECO activities are denied or recycled by using workflow, this page can be triggered by a workflow event. Previous role users can view the ECO activity that was denied or recycled, who denied or recycled it, and any associated notes. In addition, you can use this page to view ECO activities that have been approved by users within workflow.

Transferring BOMs and Routings

While the BOM and routing copy functionality enables you to copy a single BOM or routing, you can also transfer multiple BOMs or routings at the same time. You can transfer them by assembly items, either a list or range of items, but transferring BOMs and routings as part of the workflow approval/ECO release to manufacturing process is more powerful. In either case, all BOM and routing data, including multiple outputs, is transferred.

This topic discusses how to transfer BOMs and Routings.

Pages Used to Transfer BOMs and Routings

Page Name	Definition Name	Usage
<u>Transfer Selection Page</u>	EG_ENGTRNS_REQ	Define BOM and routing transfer criteria for the Engineering Transfer COBOL SQL process (ENPBTRNS).
<u>ECO Selection Page</u>	EG_ENGTRNS_REQ2	Define the ranges of ECOs by which you want to transfer BOMs and routings. All BOM and routing data, including all BOM outputs, is transferred.
<u>Assembly Selection Page</u>	EG_ENGTRNS_REQ3	Make engineering transfers by assembly item.
<u>BOM Exception Page</u>	EN_BOM_TRN_STAT	View BOM exceptions that were not valid or transferred, as well as the reason why the BOM was not valid or transferred.
<u>Routing Exception Page</u>	EN_RTG_TRN_STAT	View routing exceptions that were not valid or transferred, as well as the reason why the routing was not valid or transferred.
BOM Transfer/Copy Audit	EG_BOM_AUDIT	View all items whose engineering bill of materials (EBOM) or manufacturing bill of materials (MBOM) you have copied or transferred. The system makes a BOM Transfer/Copy Audit page entry for each EBOM transferred or copied to production.

Page Name	Definition Name	Usage
Routing Transfer/Copy Audit	EG_RTG_AUDIT	View all items whose manufacturing or engineering routings you have copied or transferred. The system also makes a Routing Transfer/Copy Audit page entry for each engineering routing transferred or copied to production. You can view all items whose engineering routings or manufacturing routings you have copied or transferred.

Transfer Selection Page

Use the Transfer Selection page (EG_ENGTRNS_REQ) to define BOM and routing transfer criteria for the Engineering Transfer COBOL SQL process (ENPBTRNS).

Navigation:

Engineering > Engineering Changes > Engineering Transfers > Transfer Selection

This example illustrates the fields and controls on the Transfer Selection page. You can find definitions for the fields and controls later on this page.

Field or Control	Description
From/To	Select the direction of the transfer: <i>Engineering to Manufacturing</i> or <i>Manufacturing to Engineering</i> .

Field or Control	Description
Transfer	<p>Select what you want to transfer: <i>BOMs</i>, <i>Routings</i>, or <i>BOMs and Routings</i>.</p> <p>If you are transferring BOMs and routings by ECOs, then this transfer option is used in conjunction with the BOM and Rtg check boxes on the ECO to determine whether the BOM, routing, or both are transferred.</p>
Transfer Options	<p>Select the transfer option. Values are:</p> <ul style="list-style-type: none"> • <i>Validate and Transfer</i>: This option validates the BOMs and routings and transfers them, depending on whether you select the Only if all BOMs/Rtgs valid (only if all BOMs and routings are valid) and Any valid BOMs/Routings options. • <i>Validate Only</i>: This option validates the BOMs and routings, but does not transfer them. <p>When you select this option, the Only if all BOMs/Rtgs valid and Any valid BOMs/Routings options are not available for selection.</p> <p>You can use <i>Validate Only</i> in conjunction with the Transfer Exceptions pages to see if any problems occurred with the BOMs or routings. You can then make any necessary corrections before you transfer the BOMs and routings.</p> <hr/> <p>Note: <i>Validate</i>, in this context, means that all BOMs and routings are valid for transfer (no placeholders, all items are approved in PeopleSoft Inventory, items are not staged date-controlled); it does not mean that the system checks for loops. You should run the BOM Verification process after you have transferred an EBOM to manufacturing.</p> <hr/>
Only if all BOMs/Rtgs valid	<p>Select to enable the system to transfer all BOMs and routings, but only if they are <i>all</i> valid; that is, they have no exceptions. When transferring BOMs, if even one BOM has an error, the system will not transfer any BOMs. When transferring routings, if even one routing has an error, the system will not transfer any routings. Finally, if you are transferring both BOMs and routings, if either one BOM or routing has an error, the system will not transfer any BOMs or routings.</p>
Any valid BOMs/Routings	<p>Select to enable the system to transfer any valid BOMs and routings; that is, those with errors will not be transferred. In either case, you can view the invalid BOMs and routings by using the Transfer Exceptions pages.</p>

Field or Control	Description
Overwrite Existing BOMs	<p>Select to enable the system to completely replace the existing BOMs.</p> <p>If you do not select this option and the system finds an existing BOM for an item, then the system will not transfer the BOM, and it will display a message in the Transfer Exceptions pages and treat it as an error.</p>
Overwrite Existing Routings	<p>Select to enable the system to completely replace the existing routings.</p> <p>If you do not select this option and the system finds an existing routing for an item, then the system will not transfer the routing, and it will display a message in the Transfer Exceptions pages and treat it as an error.</p>
Item Selection	<p>Select one of these options:</p> <ul style="list-style-type: none"> • <i>ECO</i>: Make the transfer by ECO. This option activates the fields on the ECO Selection page. • <i>Item</i>: Make the transfer by item. This option activates the fields on the Assembly Selection page.
Source BOM does not exist	<p>If you are transferring BOMs by ECOs, select if you want an exception to appear on the BOM Exceptions pages. If you do not select this option, the system displays a warning if the source BOM does not exist. By selecting this option, you can prevent the transfer of all BOMs on an ECO if, for example, an item on the ECO is flagged as requiring a BOM change when no BOM exists for the item.</p>
Source routing does not exist	<p>If you are transferring routings by ECOs, select if you want an exception to appear on the Routing Exceptions pages. If you do not select this option, the system displays a warning if the source routing does not exist.</p>

Note: The **Source BOM does not exist** and **Source routing does not exist** check boxes apply only to transfers by ECO. If you choose assembly *Item* as your item selection, then these check boxes are unavailable for selection.

ECO Selection Page

Use the ECO Selection page (EG_ENGTRNS_REQ2) to define the ranges of ECOs by which you want to transfer BOMs and routings.

All BOM and routing data, including all BOM outputs, is transferred.

Navigation:

Engineering > Engineering Changes > Engineering Transfers > ECO Selection

You can enter an ECO number range with or without the ECO schedule date range.

Transferring from PeopleSoft Engineering to PeopleSoft Manufacturing

If you are transferring from PeopleSoft Engineering to PeopleSoft Manufacturing, only approved ECOs appear as possible choices in the **ECO Number Range From** and **To** fields.

Note: The BOMs and routings for items are validated and transferred on approved ECOs if they have the appropriate **BOM Chg** (BOM change) or **Rtg Chg** (routing change) check boxes selected on the Maintain ECOs - Header: BOM/Rtg Information page or on the Maintain ECOs - Items Affected - Detail: BOM/Rtg Information page; these BOMs and routings must also have an item release status of *Pending*. When you are transferring BOMs, BOM validations occur only for items that have the **BOM Chg** check box selected; when you are transferring routings, the routing validations occur only for items that have the **Rtg Chg** check box selected. Transfers are also based on the BOM type/BOM code and routing type/routing code selected. If you leave the BOM code blank, then all BOMs for the item are transferred. Similarly, if you leave the routing code blank, all routings for the item are transferred. After the transfer is successfully made, the system updates the assembly item status to *Released*. If all BOM codes or all routing codes for the item are being transferred, all BOMs and routings must be transferred successfully before the item status can be updated to *Released*.

After you transfer BOMs from PeopleSoft Engineering to PeopleSoft Manufacturing by ECO, the system automatically updates the related ECO's header status to *Released*, if all the BOMs and routings related to the ECO are released. The system also updates the individual ECO assembly items to *Released*, if it was transferred successfully. This status is reflected on the Maintain ECOs- Items Affected: Status page.

This table lists the check boxes you need to select in the **Items Affected** group box on the ECO Header page or the Items Affected page, for individual ECO assembly items to be released on approved ECOs when you successfully transfer BOMs and routings:

When Transferring	Use These Check Boxes	Sets Release Status To
Only BOMs	BOM Chg check box must be selected; Rtg Chg check box must be deselected.	Released
Only routings	Rtg Chg check box must be selected; BOM Chg check box must be deselected.	Released

When Transferring	Use These Check Boxes	Sets Release Status To
Both BOMs and routings	<p>Both BOM Chg and Rtg Chg check boxes must be selected if both BOM codes and routing codes are being transferred.</p> <p>The BOM Chg check box must be selected if only BOM codes are being transferred.</p> <p>The Rtg Chg check box must be selected if only routing codes are being transferred.</p>	Released

Note: If, for an individual ECO assembly item, you are transferring only BOMs or only routings, but you selected both the **BOM Chg** and **Rtg Chg** check boxes on the Maintain ECOs - Header: BOM/Rtg Information page or on the Maintain ECOs - Items Affected - Detail: BOM/Rtg pages, then that item will not be set to *Released* on the Maintain ECOs - Items Affected: Status page. If you only have the **BOM Chg** check box selected or the **Rtg Chg** check box selected, and you transfer both BOMs and routing, then the ECO assembly item is released after a successful transfer of the BOM or routing.

BOM Transfer Errors

These BOM transfer errors prevent the release of an ECO:

- Assembly/Component/Output/Substitute item does not exist in target business unit.
- Assembly/Component/Output/Substitute item has a status other than *Active*, *Hold*, or *Discontinue* before it is transferred to manufacturing.
- You have not selected Existing BOMs as an overwrite option, and the BOM exists in the target.
- The *quantity per* value contains a decimal value when the quantity code is per order and the component/output item is serial-controlled.

PeopleSoft Inventory items can have decimal and whole number quantity precisions for each unit of measure (UOM). This validation applies not only to serial-controlled items, which are a subset of whole number items, but also to all items whose standard UOM has a quantity precision of Whole Number.

- The calculated quantity per assembly (QPA) for a component is less than the allowed precision as specified in the manufacturing installation page (Qty per assembly / BOM qty).

If, for example, the allowed precision is 4, then the calculated QPA cannot be less than .0001 for the component/operation sequence.

- Component ID or Output ID is a configured item.
- The source BOM does not exist, and you have selected the **Source BOM does not exist** check box (error option), when transferring by ECOs, on the Transfer Selection page.

BOM Transfer Warnings

The five BOM transfer warnings are:

- An operation sequence does not exist on the primary routing of the to be transferred item (routing code 1).
- The source BOM does not exist and you have not selected the **Source BOM does not exist** check box, when transferring by ECOs, on the Transfer Selection page.
- Assembly/Component/Output/Substitute items have a status of *Hold* or *Discontinue* before it is copied to manufacturing.
- The *quantity per* value contains a decimal value when the quantity code is per assembly, and the component/output item is serial-controlled or its standard UOM has a quantity precision of Whole Number.

Routing Transfer Errors

These routing transfer errors prevent the release of an ECO:

- The source routing does not exist and you have selected the **Source routing does not exist** check box, when transferring by ECOs, on the Transfer Selection page.
- You have not selected Overwrite Existing Routings, and the routing exists in the target.
- The assembly item of the routing is not approved.

Routing Transfer Warnings

The two routing transfer warnings are:

- An operation sequence does not exist on the to be transferred primary item routing (routing code 1).
- The source routing does not exist, and you have *not* selected the **Source routing does not exist** check box, when transferring by ECOs, on the Transfer Selection page.

Note: The existence of BOM and routing transfer warning messages does not prevent the release of an ECO.

Transferring from PeopleSoft Manufacturing to PeopleSoft Engineering

If you are transferring from PeopleSoft Manufacturing to PeopleSoft Engineering, only pending ECOs appear as possible choices in the **ECO Range From** and **To** fields.

Note: The BOMs and routings for items are validated and transferred on pending ECOs if they have the appropriate **BOM Chg** or **Rtg Chg** check boxes selected on the Maintain ECOs - Header: BOM/Rtg Information page or on the Maintain ECOs - Items Affected - Detail: BOM/Rtg page; these BOMs and routings must have an item release status of *Pending*.

Assembly Selection Page

Use the Assembly Selection page (EG_ENGTRNS_REQ3) to make engineering transfers by assembly item.

Navigation:

Engineering > Engineering Changes > Engineering Transfers > Assembly Selection

This example illustrates the fields and controls on the Assembly Selection page. You can find definitions for the fields and controls later on this page.

Item Options

You can select a range of items, and then select the from and to range of items, as well as the BOM type, BOM code, routing type, and routing code. If you enter a specific value in the **BOM Code** or **Routing Code** fields, then you are indicating that those specific codes associated with the range of items are to be transferred. If either of these fields is left blank, then you are indicating that all BOM and routing codes are to be transferred. In either case, all BOM outputs are transferred.

You can also select a list of assembly items, which enables you to select individual items.

<i>Field or Control</i>	<i>Description</i>
	If you select List of Assembly Items and click the Search button, the system displays the Select Assemblies by Items Where Used page.

Note: If you are transferring by list of assembly items, the items should have BOMs or routings associated with them.

For both item options:

- If you are transferring from PeopleSoft Engineering to PeopleSoft Manufacturing, the system displays EBOMs if you are transferring BOMs and engineering routings (ERTGs), if you are transferring routings.
- If you are transferring from PeopleSoft Manufacturing to PeopleSoft Engineering, the system displays MBOMs if you are transferring BOMs and manufacturing routings if you are transferring routings.
- If, however, you are transferring both BOMs and routings, the system displays all approved or pending inventory items that are not staged-dated.

Field or Control	Description
	Click the Item Search/Mst Rtg Where Used button to access either of these links: <ul style="list-style-type: none"> • Item Search: Click to select a different item. • Mst Rtg Where Used: Click to access the Master Routing Where Used inquiry page.
Mst Rtg (master routing)	If the routing of the item is a master (or reference) routing that is currently used by another item, then this check box is selected. This is a display-only field.

Note: When you transfer a BOM, it fully replaces the target BOM and all associated reference designators, text, document associations, and attachments. Similarly, when you transfer a routing, it fully replaces the target routing.

If you have selected the **Delete EBOMs upon Transfer** option on the Engineering Options page, the system automatically deletes the EBOM from PeopleSoft Engineering after making the transfer to PeopleSoft Manufacturing. This option does not apply when transferring from PeopleSoft Manufacturing to PeopleSoft Engineering. A similar process occurs for routings if you selected the **Delete ERTGs upon Transfer** option on the Engineering Options page.

When you run the engineering transfer process, the system logs the number of BOMs and routings processed and transferred, as well as the number of exceptions and warnings. You can view this information by using the message log from the Maintain EBOMs and Revs or Process Change Orders navigation. To create a Background Process report, use the Background Process page on the Maintain EBOMs and Revs or Process Change Orders navigation.

Related Links

[Understanding Mass BOM Changes](#)

BOM Exception Page

Use the BOM Exception page (EN_BOM_TRN_STAT) to view BOM exceptions that were not valid or transferred, as well as the reason why the BOM was not valid or transferred.

Navigation:

Engineering > Engineering Changes > Review ECO Information > Transfer Exceptions > BOM Exception

<i>Field or Control</i>	<i>Description</i>
Count	If you are not sure how many messages you have, click this button before you populate the page. When you click this button, the system displays the number of BOM exceptions and routing exceptions that will appear using the entered search criteria.

Routing Exception Page

Use the Routing Exception page (EN_RTG_TRN_STAT) to view routing exceptions that were not valid or transferred, as well as the reason why the routing was not valid or transferred.

Navigation:

Engineering > Engineering Changes > Review ECO Information > Transfer Exceptions > Routing Exception

<i>Field or Control</i>	<i>Description</i>
Count	If you are not sure how many messages you have, click this button before you populate the page. When you click this button, the system displays the number of BOM exceptions and routing exceptions that will appear using the entered search criteria.

Making Mass BOM Changes by ECO and Automatically Creating New Item Revisions by ECO

You can make mass BOM changes and automatically create new item revisions.

See "Understanding Mass BOM Changes" (PeopleSoft Manufacturing).

Managing Documents

Understanding Document Management in PeopleSoft Engineering

When integrated with the Documentum Enterprise Document Management System (EDMS), PeopleSoft Engineering provides a complete document management solution that gives selected members of your company access to up-to-date, online information, while keeping a detailed history of changes made to any document and securing access to documents, where necessary.

Using this integrated document management system, you can securely vault multiple types of documents. You can seamlessly perform online document queries and then view documents directly, launching them from within PeopleSoft applications. You can associate documents with ECRs, ECOs, item revisions, BOMs, manufacturing routings, production component lists, and production operation lists.

Prerequisites

Before you begin using Documentum, you must complete these steps:

- Install the Documentum Server (document database) and make sure that it is accessible from the PeopleSoft NT server.

When accessing Documentum functions by way of a PeopleSoft Documentum-enabled internet page, the application server accessed using the PeopleSoft page must contain the appropriate Documentum runtime libraries and access the Documentum server.

Note: It is highly recommended that you carefully assess your organization's document management requirements and put in place an overall document management strategy prior to or in conjunction with your PeopleSoft implementation.

- Indicate that Documentum is installed and also define all document installation options (such as Documentum Docbase Name and Document Object Type) using the Installation Options - Documentum page in the **Set Up Financials/Supply Chain > Install** navigation.

You can also define these installation option fields by using the Document Product Options page, also in the **Set Up Financials/Supply Chain** navigation.

- Decide for each individual document-enabled component, what level of access capabilities you will make available.

With the Documentum Component Options page, you control which components are document-enabled, as well as the document management buttons that the system displays in the individual document-enabled pages within the group.

For example, let's say that you want users to only view, but not query, ECO documents. By using the Documentum Page Options component, you determine which PeopleSoft pages within components are document-enabled.

- Set search fields based on PeopleSoft criteria.

To use the Unit, Item ID, and Revision fields on the Query page to narrow searches, you must first select the Use BU/Item/Rev Attributes field on the Document Product Options page. Also, before you enable this feature, you must make modifications to document attributes within Documentum (a modification), to support the addition of business unit, item ID, and item revision.

Note: The BU/Item/Rev Attributes feature applies only to the use of Documentum with PeopleSoft Engineering.

Related Links

"Setting Up Document Management Options" (Application Fundamentals)
[Configuring Your Document Management System](#)

Examining the Embedded Document Management System

Physical documents are always vaulted within Documentum. When a document becomes associated with a PeopleSoft page, only a minimal amount of information regarding that document is stored within PeopleSoft, such as document object ID, name, and title. PeopleSoft from Documentum, as required, retrieves all other information pertaining to the document, such as the author, checkout status, and version. In short, Documentum owns the documents, and the PeopleSoft system manages associations or references to them.

Note: To uniquely identify documents, the Documentum object ID is stored within the PeopleSoft database for each associated document. If the object ID changes for a document within Documentum, you must reestablish document associations within the PeopleSoft system. Under normal use, object IDs within Documentum don't change for a particular document version.

Document User Types

Three types of users can interact with documents:

- Contributors: Users who actually introduce new or revised documents within the document vault.
- Coordinators: Users who maintain and manage the coordination of documents within the system.
- Consumers: Users who require access to various documents.

The typical roles of each of these user types include:

- Document contributor role: The document contributor adds new documents or versions of existing documents to the Documentum Docbase, using Documentum client or web-based applications such as Workspace or RightSite.

- Document coordinator role: The document coordinator administers the document vault coordination required with the Documentum EDMS.

This includes organization of documents in cabinets and folders as well as defining security. You can't manage this function by using the PeopleSoft system.

- Document consumer role: The document consumer accesses various documents from within PeopleSoft pages and Documentum applications.

Consumers are end users who need to query, access, and use documents. Using PeopleSoft pages, consumers also manage PeopleSoft document associations with Documentum. By associating documents with PeopleSoft pages, the consumer creates a dynamic link between PeopleSoft pages and documents within the vault.

Related Links

[Associating Documents to Pages and Copying Document Associations](#)

Adding New Documents or New Versions of Existing Documents to the Vault

You must use a Documentum client or web-based application, such as RightSite, WorkSpace, or SmartSpace, to contribute new documents or versions to the vault. From within PeopleSoft Documentum-enabled pages, you can launch Documentum web-based applications (such as RightSite) by clicking a button once you have set up the correct URL entry for your Documentum installation.

Associating Documents to Pages and Copying Document Associations

You can associate or link documents to the originating page in one of two ways:

- Run a query against the Documentum vault and choose which documents to associate to the page.

With this action, you create the initial association of a vaulted document to a PeopleSoft page. There is no limit to the number of times you can query and associate documents to a PeopleSoft page.

- Click the **Copy** button on any document-enabled page to copy a selected list of document associations (not the document itself) from other PeopleSoft Engineering or Manufacturing document-enabled pages.

This feature enables you to replicate document associations throughout document-enabled pages. For example, you can copy documents associated with the item REV Documents page to the ECR Documents page as new requests for change are entered or you can deploy documents associated with an ECO to an item's routing for use within.

Managing Documents in PeopleSoft Engineering

By providing pages that include an embedded document management system, PeopleSoft Engineering enables you to access and manage related documents.

This topic discusses how to manage documents in PeopleSoft Engineering.

Pages Used to Manage Documents in PeopleSoft Engineering

<i>Page Name</i>	<i>Definition Name</i>	<i>Usage</i>
<u>Component Options Page</u>	DC_PNLGRP	Control, by product and component, the document management buttons that the system displays in document components.
Document Details Page	DC_DOC_DETAILS_SP	View information about the selected document from the document vault. <u>Search Results Page</u>
<u>Query Page</u>	DC_QRY_REQ_SP	Make attribute selections to narrow the focus of your search. You can also use it to associate documents with the original document-enabled page.
<u>Search Results Page</u>	DC_QRY_RESULT_SP	Display each document in the database that matches the query criteria that you entered on the Query page.
<u>Copy Document Associations Page</u>	DC_COPY_SP	Associate or link documents to the originating page.

Component Options Page

Use the Component Options page (DC_PNLGRP) to control, by product and component, the document management buttons that the system displays in document components.

Navigation:

Set Up Financials/Supply Chain > Common Definitions > Documentum > Component Options > Component Options

This example illustrates the fields and controls on the Component Options page. You can find definitions for the fields and controls later on this page.

Component Options

Component Name BOM_MAINTENANCE BOM Maintenance







PS Product Details

*Document Enabled PS/Product Engineering / Manufacturing Engineering / Manufacturing

Component Type Maintenanc Maintenanc

Documentum Docbase Name dmdoc31







Valid Actions



 
 
 
  
 

With this page, you control the document management buttons that the system displays on any of the document-enabled pages. For demonstration purposes, we used the Revision Maintenance - Documents page. You could also use any of the other document-enabled pages as an example because the embedded document functionality, including Query and Search Results pages, is virtually identical.

After you select your business unit (and item ID), the system displays a list of all documents associated with the particular revision of the item. This list includes the document name and title, as defined in Documentum, and whether the document is fixed.

This table contains a summary of the buttons that you can click within document-enabled pages, and the actions that they perform.

Field or Control	Description
	Click to view document detail.
	Click to query the Documentum database.
	Click to view document contents.
	Click to launch Documentum.
 	Click to fix or unfix versions.
	Click to copy document associations.

<i>Field or Control</i>	<i>Description</i>
	Click to deselect all check boxes.
	Click to select all check boxes.

Signing In to the Documentum Docbase

To access (query or view) associated documents in the document database from PeopleSoft pages, you must be signed in to Documentum.

The first time during a session that you click any of the buttons on the document-enabled page, the system prompts you to sign in to Documentum.

Note: Once you successfully sign in to Documentum, you'll remain signed in until you end your session by closing the browser.

Query Page

Use the Query page (DC_QRY_REQ_SP) to make attribute selections to narrow the focus of your search.

You can also use it to associate documents with the original document-enabled page.

Navigation:

Click the **Query** button on any document-enabled page.

<i>Field or Control</i>	<i>Description</i>
Format	Select the Documentum document file format. This isn't necessarily the same as the file extension. For example, you define a Microsoft Word document in Documentum as having a file format of msw6 (created with either Word 6.0 for the Mac or Word 6.0 or 7.0 for Windows), but the file extension is <i>.doc</i> .

Field or Control	Description
Search Options	<p>Except for the optional Document contains word(s) search and Version Option, each field has these search options:</p> <ul style="list-style-type: none"> • <i>begins with</i> • <i>Contains</i> • <i>ends with</i> • <i>is equal to</i> • <i>is greater than or equal to</i> • <i>is greater than</i> • <i>is less than or equal to</i> • <i>is less than</i> • <i>is not equal to</i>

Specify to query by all versions or a specific version; *CURRENT* is the specific version default. When you query by all versions or by a specific version that isn't current, the document can only be associated with a PeopleSoft page as *fixed*. The specific version can be any version label defined in Documentum; however, if you specify a document as *not fixed* on a PeopleSoft page, the version label used to identify the current document is always *CURRENT*.

The **Unit**, **Item ID**, and **Revision** fields enable you to narrow searches based on PeopleSoft criteria. To access these fields, you must first have selected the Use BU/Item/Rev Attributes field on the Document Product Options page on the **Set Up Financials/Supply Chain** navigation. Before you enable this feature, you must modify document attributes within Documentum.

Searching by Using the Keywords Field

Within Documentum, you have the ability to maintain multiple keywords for each version of a document. The **Keyword(s)** field on the Query page enables you to search on one or more of these keywords. To search on more than one key word, separate each keyword with a comma.

Searching by Using the Document Contains Word(s) Field

If you have enabled full-text indexing of documents within Documentum, you can search within the document itself for strings that you enter here.

Related Links



"Setting Up Document Management Options" (Application Fundamentals)

Search Results Page

Use the Search Results page (DC_QRY_RESULT_SP) to display each document in the database that matches the query criteria that you entered on the Query page.

Navigation:

Click the **Start Query** button on the Query page.

<i>Field or Control</i>	<i>Description</i>
	<p>Display document detail or view documents by selecting the Sel (select) check box and clicking either the Document Detail button or View button.</p> <p>Select the Sel check box and click OK to associate documents back with the originating document-enabled page.</p>
	<p>Click the Select All button to include all documents to be associated. When you click this button, the system selects all of the Sel check boxes.</p>
	<p>Click the Deselect All button to deselect all of the Sel check boxes.</p>

Copy Document Associations Page

Use the Copy Document Associations page (DC_COPY_SP) to associate or link documents to the originating page.

Navigation:

Click the **Copy** button on any document-enabled page.

The fields on the Copy Document Associations page vary, depending on your Copy From selection from the available options.

Note: When you associate documents, the system retrieves the document name and title from the document database at the time the document is associated with a page. If you change the name and title later in the document database, the change isn't automatically reflected within PeopleSoft pages. You must disassociate and reassociate the document to PeopleSoft pages to reflect changes to name and title. However, all other document attributes (such as author and format) aren't stored within the PeopleSoft pages, so if any one of these attributes is changed in Documentum, you don't need to reassociate the document with the page.

Disassociating Documents from Pages

You can disassociate documents from a document-enabled page by clicking the **Delete** button associated with the row that you want to disassociate. Disassociating documents from pages has no impact on the document within the document database because it does not delete the document.

Viewing, Editing, Checking In and Out, and Fixing Documents

Viewing Documents

<i>Field or Control</i>	<i>Description</i>
	<p>Click the View button on the document-enabled page to launch the selected document for viewing only. When you view a document using PeopleSoft pages, the system retrieves a local copy of the document from the Documentum server (by using Documentum RightSite).</p>

Editing, Checking In, and Checking Out Documents

<i>Field or Control</i>	<i>Description</i>
	<p>Click the Launch Documentum button on the document-enabled page to access documents for check out, check in, canceling checkout, and editing. You perform these functions directly within Documentum applications.</p>

Fixing Documents

Field or Control	Description
	<p>Click the Fix Vers (fix version) button on the document-enabled page to fix this document association on this page to the specific document version currently selected. The fix only applies to the document as it relates to the current page. Therefore, if you fix the document to the Revisions Documents page, the system doesn't fix it to any of the other document-enabled pages, such as ECR and ECO.</p> <p>When you fix an associated document to a page, the currently displayed version of the document is <i>permanently</i> associated with the page, without regard to future document revisions.</p> <p>When you fix a document to a PeopleSoft page, subsequent versions of the document aren't automatically associated with this page. Typically you won't fix a particular document to the page until the version of the document is final.</p> <p>As an example, you might find it necessary, during the life of a particular ECO, to set associated documents to <i>not fixed</i> so that as engineering checks in new versions of design documents, they are always visible from within the ECO page. Once the ECO is approved, the design documents can be <i>fixed</i> to permanently associate appropriate versions with the PeopleSoft page.</p> <p>Changing a document to fixed does this:</p> <ul style="list-style-type: none"> • The version currently associated with the page becomes fixed to the originating page so that any subsequent checked-in versions of the document aren't associated with this page. • The document, while fixed, can no longer be checked out from this page. • The Fixed check box on the documents page changes from <i>N</i> to <i>Y</i>.

Field or Control	Description
	<p>Click the Unfix Vers (unfix version) button on the document-enabled page to <i>unfix</i> a fixed document, thereby reassociating the page document with the current version.</p> <hr/> <p>Warning! If you <i>unfix</i> a document and then <i>fix</i> it again, the fixed document becomes by default the latest (most current) version, as defined within the document database, and might not be the same as the version that was originally fixed.</p> <hr/> <p>For example, you fix a document to a PeopleSoft ECO page at version 1.0, and afterward you check versions 1.1 and 1.2 of the document into the document database. Then, if you <i>unfix</i> and <i>fix</i> the document again in the ECO Page, the fixed version of the ECO page is 1.2 instead of the 1.0 version prior to unfixing. This enables you to correct a document association that has been fixed prematurely.</p> <p>Likewise, if you fix the document at version 1.2, but it should have been fixed at 1.0, you can query the document again for version 1.0. When you query a specific version, it is associated with the page as <i>fixed</i>.</p> <hr/> <p>Note: Be sure to delete the original document association, if you want. It's possible to have more than one version of the same document associated with a page.</p> <hr/>

Related Links

[Component Options Page](#)

Modifying Page Objects and PeopleCode

Depending on your document management requirements, you might want to modify Documentum and potentially PeopleSoft page objects and PeopleCode to meet your own business requirements. One such example is document revision numbering techniques. This can include:

- Adding the Revision field as a user-defined attribute.
- Modifying Documentum code to generate the revision number.
- Modifying page objects and PeopleCode to gain access and visibility to revision numbers within the PeopleSoft system.

Printing Documents

Printing documents from the client is dependent on the client software that you are using to view documents. To print a document, you must first launch the document in view mode.

Managing BOMs and Engineering Changes for Suppliers

Understanding BOMs and Engineering Changes for Suppliers

This topic lists prerequisites for BOM inquiries and engineering changes for suppliers and discusses:

- Capabilities to share PeopleSoft Engineering information.
- Attachments and email capability.
- Functionality reflected in PeopleSoft Manufacturing and PeopleSoft Engineering.

Prerequisites

Before your suppliers can access specific inquiries, you must:

- Set up secured external access for suppliers.

To give access to PeopleSoft Engineering information for suppliers, you must establish appropriate external facing internet access. Implementations for this vary by customer site depending on firewall configurations. However, the basic setup provides external supplier access to only the SUPPLIER registry—by way of a uniform resource locator (URL)—within your PeopleSoft system.

- Define suppliers by using the Supplier Information component in PeopleSoft Purchasing.

See "Understanding Supplier Maintenance" (PeopleSoft Source to Settle Common Information).

- Enable suppliers to log in.

Set up supplier profiles by associating suppliers with a user ID. Use the Supplier User Setup component in PeopleSoft Purchasing to associate each user ID with one or multiple supplier codes. Then when a supplier user logs in to PeopleSoft Engineering, the system determines to which supplier the user is associated. If a user is associated with multiple suppliers, the Select Supplier page enables the user to select from a list which supplier the user is interested in viewing. If no supplier code is assigned to the user, then the system administrator must assign a supplier code to a user ID.

If you have installed PeopleSoft eSupplier Connection, you can also enable suppliers to allow their own employees access to PeopleSoft Engineering. Providing this direct access relieves your own employees of the task of administering access permissions. You always retain control of the type of access that each supplier's users are allowed.

See "Supplier Profiles" (PeopleSoft Source to Settle Common Information).

See [Select Supplier Page](#).

See "Establishing Self-Service Security for Suppliers" (PeopleSoft eSupplier Connection).

- Define BOM, ECR, and ECO access privileges by supplier.

Before your suppliers can access the ECR, ECO, and BOM data that you want them to view and, in the case of ECRs, possibly create or update, you must give the suppliers, from within the PeopleSoft system, access to the data at the item level. With the BOM Access by Supplier page, you can associate business unit items with suppliers, thereby granting suppliers item access by supplier code. Specify the business unit items (including BOM type and BOM code) to which each supplier has access, and specify whether suppliers can view the associated BOMs, ECRs, and ECOs.

See "BOM Access by Supplier Page" (PeopleSoft Manufacturing).

- Set up supplier BOMs, attachments, and email capability.

See [Attachments and Email Capability](#).

- Set up supplier-related BOMs and engineering changes functionality with Documentum.

If you have installed Documentum, the suppliers view documents associated with BOMs, ECOs, and ECRs within PeopleSoft Manufacturing and PeopleSoft Engineering.

See [Understanding Document Management in PeopleSoft Engineering](#).

- Be aware of the ways in which supplier-related BOMs and engineering changes are reflected in PeopleSoft Manufacturing and PeopleSoft Engineering.

See [Attachments and Email Capability, Functionality Reflected in PeopleSoft Manufacturing and PeopleSoft Engineering](#).

- Determine whether you'll implement workflow and whether the supplier is included as an approval step in workflows defined by ECO type.
- (Recommended) Define procedures regarding timing of supplier access (controlled for each ECO).

Capabilities to Share PeopleSoft Engineering Information

Because today's business world often requires more outsourcing, there's a need to share information more effectively between customers and their suppliers. With PeopleSoft Engineering, you can:

- Collaborate with suppliers regarding engineering information that you control as a customer.
- Provide internet access to suppliers so that they can access BOM structures and documents through the internet.
- Provide suppliers with the ability to view, create, or update ECRs, as well as review and approve ECOs and any supplier-related ECO workflow steps.
- Send workflow-generated notifications or specific email notifications (or both) containing links to quickly direct suppliers to pertinent information.
- Establish which BOMs, ECRs, and ECOs can be viewed and accessed by specific suppliers.
- Attach any documents that support new product introductions or the change process.

Attachments and Email Capability

Suppliers can view, upload, and delete attachments in PeopleSoft Engineering. Following is a summary of the functionality and what you must know before starting to use attachments:

- Using links, suppliers can view attachments for BOMs at both the header and component level.

Suppliers can't, however, add or delete attachments to BOMs.

- Using links, suppliers can view attachments for ECOs at both the header and item level.

Suppliers can add attachments for ECOs (if you grant them add ECO attachment privileges on the BOM Access by Supplier page). The system adds the attachment to the file server and creates an attachment row. The supplier can only change the description. While in the same session, suppliers can, prior to saving, delete any ECO attachments that they've added. This is because suppliers do not "own" the ECO, thus preventing suppliers from deleting attachments added internally.

- Using links, suppliers can view attachments for ECRs at both the header and item level.

Suppliers can also add attachments for ECRs (if you grant them add ECR attachment privileges on the BOM Access by Supplier page). Unlike for ECOs, suppliers can delete attachment rows that are added in the same session, as well as delete existing rows (allowed because the supplier "owns" the ECR).

- In cases where suppliers are allowed to delete attachments (such as ECRs), they are actually deleting attachment rows only from the page; the file itself isn't deleted from the file server.

This helps prevent suppliers from deleting files (by file name) that you own.

- As is the case for all PeopleSoft applications, in PeopleSoft Engineering, file extensions of documents uploaded by suppliers must be already defined within general options.

For each ECR or ECO attachment format that you accept from suppliers, you must define an extension on the File Locations page in the Define General Options navigation.

Note: File extensions are case-sensitive on the File Locations page. Therefore, you may need to define both .DOC and .doc extensions on the File Locations page to accept uppercase and lowercase attachments from suppliers.

- You can maintain the ATTACHMENT URL identifier by using the URL Maintenance page in PeopleTools.

You must set up this URL to point to the File Transfer Protocol (FTP) location where you'll store secured supplier attachments. Define this URL to point to the same location as attachments defined in file locations and file executables, because PeopleSoft Manufacturing and PeopleSoft Engineering ECR or ECO or BOM attachments must point to the same location to share the same documents. If, for security reasons, you do not want to do this, then you can store attachments in a separate location. If PeopleSoft Manufacturing and PeopleSoft Engineering ECOs or ECRs or BOMs must share attachments, then you must replicate files (outside of the PeopleSoft system) in both locations.

Note: In setting up the ATTACHMENT URL identifier, the URL string syntax must be defined as an FTP location. In contrast, "file attachments" doesn't utilize FTP.

Related Links

"Header: Send Email to Suppliers - New Message Page" (PeopleSoft Manufacturing)

Functionality Reflected in PeopleSoft Manufacturing and PeopleSoft Engineering

The supplier-related BOM inquiry and engineering change functionality is reflected in PeopleSoft Manufacturing and PeopleSoft Engineering. Following is a list describing how to use the pages in each application:

- Use the BOM Access by Supplier page in PeopleSoft Manufacturing to define privileges for viewing ECO and BOM data and, in the case of ECRs, to add information.
- Send email to suppliers from these pages: ECO Maintenance - Header, ECR Maintenance - Header, Approve ECO, and Engineering BOM Maintenance - Header: Supplier Access List in PeopleSoft Engineering, and BOM Maintenance - Header: Supplier Access List in PeopleSoft Manufacturing.

Note: Each email message contains two URLs.

- Access the supplier access list from these pages to display a list of suppliers who have access to a specific item: EBOM Maintenance Header, ECR Header - Header, and ECO Header - Header in PeopleSoft Engineering, and BOM Maintenance Header in PeopleSoft Manufacturing.
- On both the PeopleSoft Engineering ECO Header - Header and ECR Header - Header pages, use the **Not Accessible by Suppliers** field to block access to a specific ECO or ECR.

Therefore, even if suppliers have been granted access on the BOM Access by Supplier page in PeopleSoft Manufacturing, you can deny them access to a specific ECO.

Related Links

"Header: Send Email to Suppliers - New Message Page" (PeopleSoft Manufacturing)

" Header: Supplier Access List Page" (PeopleSoft Manufacturing)

"BOM Access by Supplier Page" (PeopleSoft Manufacturing)

Maintain ECRs - Header: Header Page

Common Elements Used in Managing BOMs and Engineering Change Orders for Suppliers

<i>Field or Control</i>	<i>Description</i>
Set filter options	Click to view requests for different business units or to view non-pending change requests.
Return to supplier List	Click to return to the Select supplier page.
Documents	This group box is accessible only if Documentum is installed.

Viewing BOMs

To grant suppliers access to BOMs, use the BOM Access by Vendor (EN_IC_BOM_PRIV) component.

Use these pages to view BOMs for all items to which you have given access with the BOM Access by Supplier page. Prior to selecting which item BOMs to view, if the user is associated with multiple suppliers (that is, if the user is representing multiple supplier sites as a corporate supplier user), the supplier sees a Select Supplier page.

This topic discusses how to view BOMs.

Pages Used to View Supplier-Related BOMs

<i>Page Name</i>	<i>Definition Name</i>	<i>Usage</i>
Select Supplier Page	EN_SS_VND_LIST	Select the supplier whose information you want to appear on the BOM.
Select Bill of Material Page	EN_ICBOMVNDLST	Select an item whose BOM is to be viewed.
Filter Options Page	EN_IC_BOM_SEARCH	Narrow the search for BOMs.
Bill of Material Page	EN_ICBOMINQ_HDR	View BOMs.
Component Detail Page	EN_ICBOMINQ_COMP	View BOM component detail.

Related Links

"Defining BOM, ECR, and ECO Access by Supplier" (PeopleSoft Manufacturing)

[Prerequisites](#)

Select Supplier Page

Use the Select Supplier page (EN_SS_VND_LIST) to select the supplier whose information you want to appear on the BOM.

Navigation:

Review Product Design > View Bills of Material

A list of the suppliers to which your suppliers are linked appears. Select the supplier whose information you want to display. The system then displays the Select Bill of Material page, which lists the items available to that supplier.

Select Bill of Material Page

Use the Select Bill of Material page (EN_ICBOMVNDLST) to select an item whose BOM is to be viewed.

Navigation:

- **Review Product Design > View Bills of Material** (if not associated with multiple suppliers)
- Click one of the supplier names on the Select Supplier page (if associated with multiple suppliers).

Field or Control	Description
Item IDs	<p>Displays the IDs to which the supplier has been granted access with the BOM Access by Supplier page.</p> <hr/> <p>Note: The component item identifiers displayed in the Item ID field are those of the supplier if defined for the supplier and item combination with the Purchasing Attributes component in PeopleSoft Inventory. If no supplier and item information exists, then the customer item appears. View both supplier and customer item IDs on the Component Detail page. Define supplier item IDs using the Item Supplier page in PeopleSoft Inventory.</p> <hr/>
Set filter options	Click to view rework and to view engineering bills of material (EBOMs).

Related Links

"Purchasing Attributes -Item Supplier (ITM_VENDOR)Page" (PeopleSoft Purchasing)

Filter Options Page

Use the Filter Options page (EN_IC_BOM_SEARCH) to narrow the search for BOMs.

Navigation:

Click the **Set filter options** link on the Select Bill of Material page.

Field or Control	Description
Search Criteria	Enter your search criteria, including BOM state (<i>Manufacturing</i> or <i>Engineering</i>) and BOM type (<i>Production</i> or <i>Rework</i>).

Bill of Material Page

Use the Bill of Material page (EN_ICBOMINQ_HDR) to view BOMs.

Navigation:

Click an item ID on the Select Bill of Material page.

Field or Control	Description
As of Revision	Select to limit your search if the item is revision-controlled.
Level	Select a level to display components in that level.
Refresh button	Click to refresh the Components list after supplier changes the value for As of Revision and/or Level fields.
Quantity Per	Displays the quantity per order or assembly.
Item ID	Click to view component details for this item.
Return to Selected Bill of Material	Click to return to the Select Bill of Material page.
Send Email	Click to send email. The email will contain a URL to this specific Bill of Material page, as well as a URL to the BOM Maintenance - Summary page in PeopleSoft Manufacturing (if the BOM is a manufacturing BOM) or the Engineering BOM Maintenance - Summary page in PeopleSoft Engineering (if the BOM is an EBOM).

Related Links

"Header: Send Email to Suppliers - New Message Page" (PeopleSoft Manufacturing)

"Understanding BOM Maintenance" (PeopleSoft Manufacturing)

Component Detail Page

Use the Component Detail page (EN_ICBOMINQ_COMP) to view BOM component detail.

Navigation:

Click an item ID on the Bill of Material page.

This page displays the dimensions, reference designators, attachments, substitute items, and manufacturer's information of the component.

Field or Control	Description
Return to Bill of Material	Click to return to the Bill of Material page.

Viewing, Adding, or Updating ECRs

Using these pages, your suppliers can view and even add or update ECRs to which you have given them access using the BOM Access by Supplier page. If the login role is associated with multiple suppliers, prior to selecting the ECRs in which the supplier is interested, the supplier sees a Select Supplier page.

This topic discusses how to view, add, or update ECRs.

Pages Used to View, Add, or Update Supplier-Related ECRs

<i>Page Name</i>	<i>Definition Name</i>	<i>Usage</i>
Select Supplier Page	EG_SS_VND_LIST	Select a supplier for ECRs.
Select Change Request Page	EG_IC_ECR_LIST	Select ECRs to view and, if given the appropriate privileges, update.
Filter Options Page	EG_IC_ECR_SEARCH	Narrow the search for ECRs.
Change Request Detail Page	EG_IC_ECR_HDR	View ECR detail information.
Engineering Change Request - Item Affected Detail Page	EG_IC_ECR_ASSY_RES	View ECR item-affected information.

Related Links

"Defining BOM, ECR, and ECO Access by Supplier" (PeopleSoft Manufacturing)

Select Supplier Page

Use the Select Supplier page (EG_SS_VND_LIST) to select a supplier for ECRs.

Navigation:

- **Select Review Product Design > Engineering Change Request** (if not associated with multiple suppliers)
- Click one of the supplier names on the Select Supplier page (if associated with multiple suppliers).

A list of the suppliers to which your suppliers are linked appears. Your suppliers can select the supplier whose information they want to view. The system then opens the Select Change Request page, which displays the ECRs available to that supplier.

Select Change Request Page

Use the Select Change Request page (EG_IC_ECR_LIST) to select ECRs to view and, if given the appropriate privileges, update.

Navigation:

Review Product Design > Engineering Change Request

A list of all pending change requests appears for the default business unit to which the access has been granted.

<i>Field or Control</i>	<i>Description</i>
Item ID	<p>The component identifiers that appear in this column are those of the supplier if they are defined for the supplier and item combination with the Purchasing Attributes component in PeopleSoft Inventory. If no supplier and item information exists, then the customer item appears. You can define supplier item IDs using the Item Supplier page in PeopleSoft Inventory.</p> <p>Suppliers can view a particular ECR if they created the ECR or if they have been given access to at least one of the affected items that the ECR impacts. If a supplier has ECR update privileges, then the supplier can submit new ECRs and update change requests created by the supplier. The supplier owns any request added by the supplier and can modify only change requests that the supplier owns. Suppliers can edit their ECRs but not your internally created ECRs. If the supplier doesn't have update privileges, then the supplier can only view ECRs; all change request fields are display-only, and all Add, Upload an Attachment, Delete, and Save buttons on the Change Request Detail page are unavailable.</p>
Add a Change Request and Edit	<p>If you have granted update ECR privileges to a supplier, then the system displays these buttons, enabling the supplier to add a new ECR or edit an existing ECR. These buttons access the Change Request Detail page.</p> <hr/> <p>Note: Suppliers are not prompted for business units when adding new requests. All change requests created by suppliers are created for the default business unit defined on the User Preferences page for the supplier user.</p> <hr/>

Note: The ECR Maintenance - Header page has a **Not Accessible by Supplier** check box, which, if selected, blocks supplier access to specific ECRs. Therefore, even if suppliers have been granted access on the BOM Access by Supplier page, you can prevent supplier access to specific ECRs.

Related Links

[Creating and Maintaining ECRs](#)

"Defining BOM, ECR, and ECO Access by Supplier" (PeopleSoft Manufacturing)

Filter Options Page

Use the Filter Options page (EG_IC_ECR_SEARCH) to narrow the search for ECRs.

Navigation:

Click the **Set filter options** link on the Select Change Request page.

Search for additional change requests by description, status, priority, and item.

Change Request Detail Page

Use the Change Request Detail page (EG_IC_ECR_HDR) to view ECR detail information.

Navigation:

Click a request number, click the **Add a Change Request** button, or click the **Edit** button on the Select Change Request page.

Field or Control	Description
Upload an Attachment, Delete, and Add	<p>These buttons are available if a supplier clicked the Add a Change Request or Edit buttons to access this page. These buttons enable suppliers to add, upload, or delete data on this page.</p> <p>If the supplier has add ECR attachments capability (defined with the BOM Access by Supplier page), the supplier can upload new attachments or delete attachments as part of adding or modifying an ECR.</p> <p>If the supplier accessed this page by selecting a specific request number on the Select Change Request page, this page is display-only, and these buttons are unavailable.</p>
Items Affected	<p>If the supplier owns the change request, then the supplier can enter any item in this group box. The supplier has limited access to the item prompt table; the system displays only items to which the supplier has been granted access. Any valid item entered is accepted by the system. To enter a brand new item, the supplier must select <i>New</i> in the Type column.</p>
Reasons and Actions	<p>If the supplier owns the change request, then the supplier can add or delete items in these group boxes.</p>
Return to Select Change Request	<p>Click to return to the Select Change Request page.</p>
Send Email	<p>Click to send email. The email contains a URL back to this specific Change Request Detail page, as well as a URL to the ECR Maintenance - Header page in PeopleSoft Engineering.</p>
Save	<p>This button is available if the supplier clicks the Add a Change Request or Edit buttons on the Select Change Request page.</p>

Related Links

"Defining BOM, ECR, and ECO Access by Supplier" (PeopleSoft Manufacturing)

Engineering Change Request - Item Affected Detail Page

Use the Engineering Change Request - Item Affected Detail page (EG_IC_ECR_ASSY_RES) to view ECR item-affected information.

Navigation:

Click the **Item Details** button in the **Items Affected** group box on the Change Request Detail page.

<i>Field or Control</i>	<i>Description</i>
Add, Upload an Attachment, and Delete	<p>These buttons are available if the supplier clicked the Add a Change Request or Edit buttons on the Select Change Request page to access the Item Affected Detail page. These buttons enable the supplier to add, upload, or delete data on this page.</p> <p>If the supplier accessed the Change Request Detail page (the page used to access the Item Affected Detail page) by selecting a specific request number on the Select Change Request page, then both the Change Request Detail page and the Item Affected Detail page are display-only.</p>
Return to Change Request Detail	Click to return to the Change Request Detail page.
View Production BOM and View Engineering BOM	If the supplier clicks these links, the system displays the Bill of Material page, which lists the current affected item. These links are unavailable if the affected item doesn't have a BOM or if the supplier doesn't have access to the BOM.

Related Links

"Defining BOM, ECR, and ECO Access by Supplier" (PeopleSoft Manufacturing)

Viewing ECOs/Workflow

Using these pages, your suppliers can view ECOs to which you have given them access. If a supplier is associated with multiple suppliers, prior to selecting the ECOs in which the supplier is interested, the supplier sees a Select Supplier page.

Pages Used to View Supplier-Related ECOs/Workflow

Page Name	Definition Name	Usage
Select Supplier Page	EG_SS_VND_LIST	Select the supplier whose information you want to view on ECOs. Your supplier must be linked to more than one supplier for the system to display this page. Otherwise, it goes directly to the Select Change Order page.
Select Change Order Page	EG_IC_ECO_LIST	Select an ECO from a list of all pending change orders for the default business unit to which access has been granted. Suppliers can view a specific ECO if granted access to at least one affected item on the order. A supplier can also view a change order if the supplier is one of the approvers of the order. When the supplier is an approver, it isn't required that the affected items be set up on the BOM Access by Supplier page.
Filter Option Page	EG_IC_ECO_SEARCH	Set ECO filter options to narrow the search for ECOs. Select Change Order Page
Change Order Detail Page	EG_IC_ECO_HEADER	View ECO detail information.
Engineering Change Order - Item Affected Detail Page	EG_IC_ECO_ASSY_RES	View ECO item-affected information.

Related Links

[Understanding PeopleSoft Engineering ECOs](#)

"Defining BOM, ECR, and ECO Access by Supplier" (PeopleSoft Manufacturing)

Select Supplier Page

Use the Select Supplier page (EG_SS_VND_LIST) to select the supplier whose information you want to view on ECOs.

Your supplier must be linked to more than one supplier for the system to display this page. Otherwise, it goes directly to the Select Change Order page.

Navigation:

Review Product Design > Engineering Change Order

Select the supplier whose item information you want to appear. The system then opens the Select Change Order page, which displays the ECOs available to that supplier.

Select Change Order Page

Use the Select Change Order page (EG_IC_ECO_LIST) to select an ECO from a list of all pending change orders for the default business unit to which access has been granted.

Suppliers can view a specific ECO if granted access to at least one affected item on the order. A supplier can also view a change order if the supplier is one of the approvers of the order. When the supplier is an approver, it isn't required that the affected items be set up on the BOM Access by Supplier page.

Navigation:

- **Select Review Product Design > Engineering Change Order** (if not associated with multiple suppliers)
- Click one of the supplier names on the Select Supplier page (if associated with multiple suppliers).

<i>Field or Control</i>	<i>Description</i>
Item ID	The component item identifiers in this column are those of the supplier if they are defined for the supplier and item combination using the Purchasing Attributes component in PeopleSoft Inventory. If no supplier and item information exists, then the customer item appears. You can define supplier item IDs using the Item Supplier page in PeopleSoft Inventory.

Note: The ECO Maintenance - Header page contains a **Not Accessible by Suppliers** check box, which, if selected, blocks access to specific ECOs. Therefore, even if suppliers have been granted access on the BOM Access by Supplier page, you can prevent supplier access to specific ECOs.

Change Order Detail Page

Use the Change Order Detail page (EG_IC_ECO_HEADER) to view ECO detail information.

Navigation:

Click an order number on the Select Change Order page.

<i>Field or Control</i>	<i>Description</i>
Upload an Attachment	If a supplier has the capability to add ECO attachments (defined with the BOM Access by Supplier page), the supplier can upload new attachments. If the privilege is granted, the Save button is available. While in the same session, the supplier can also delete attachments prior to saving. Once an attachment is uploaded and the ECO is saved, the supplier can't delete the attachment.
Return to Select Change Order	Click to return to the Select Change Order page.

Field or Control	Description
Send Email	Click to send email. The email contains a URL to this specific Change Order Detail page, and a URL to the ECO Maintenance - Header page in PeopleSoft Engineering.
Approval Action	<p>If a supplier is listed in the Approval Process group box as the current approver, then the Approval Action group box becomes visible, and the supplier can approve, deny, or recycle the ECOs. Otherwise, this group box is unavailable.</p> <p>When the supplier is included as an approver within a workflow step, the supplier can be automatically notified by email. This email contains a URL to the originating ECO page for the specific ECO requiring approval. When PeopleSoft Engineering is enabled for suppliers, the supplier can also access pertinent workflow information by using the task worklist pagelet functionality.</p>
Comments	After reviewing the ECO, a supplier can enter text in this field. Then, if the supplier step is the next step for approval, the supplier can approve, deny, or recycle the ECO by clicking the appropriate buttons.
Approve button	If a supplier clicks this button, the approver in the next step of the approval process is notified by email and worklist entry.
Deny and Recycle buttons	If the supplier clicks either of these buttons, the approver in the previous step is notified. Furthermore, when denied or recycled, the current action is reset, and the originator of the ECO is notified by email. To indicate when the originator (the person who submitted the ECO for workflow) should be notified in the approval process, use the System Workflow Rules page in the General Options navigation.

Engineering Change Order - Item Affected Detail Page

Use the Engineering Change Order - Item Affected Detail page (EG_IC_ECO_ASSY_RES) to view ECO item-affected information.

Navigation:

Click an item ID in the **Items Affected** group box on the Change Order Detail page.

<i>Field or Control</i>	<i>Description</i>
Upload an Attachment	If a supplier has the capability to add ECO attachments (defined with the BOM Access by Supplier page), the supplier can upload new attachments. If the privilege is granted, the Save button is available. While in the same session, the supplier can also delete attachments prior to saving. Once an attachment is uploaded and the ECO is saved, the supplier can't delete the attachment.
Return to Change Order Detail	Click to return to the Change Order Detail page.
View Production BOM and View Engineering BOM	If a supplier clicks either of these links, the system opens the Bill of Material page, which displays the current affected item. These links are unavailable if the affected item doesn't have a BOM or if the supplier doesn't have access to the BOM.

Related Links

[Creating and Maintaining ECOs](#)

"Defining BOM, ECR, and ECO Access by Supplier" (PeopleSoft Manufacturing)

Delivered Workflows for PeopleSoft Engineering

Appendix: Delivered Workflows for PeopleSoft Engineering

This topic discusses delivered workflows for PeopleSoft Engineering.

See also the product documentation for: *PeopleTools: Workflow Technology* and *PeopleTools: PeopleSoft Applications User's Guide*.

[Understanding PeopleSoft Engineering ECRs](#)

[Understanding PeopleSoft Engineering ECOs](#)

[Understanding ECR and ECO Processing](#)

Delivered Workflows for PeopleSoft Engineering

This section discusses PeopleSoft Engineering workflows. The workflows are listed alphabetically by workflow name.

ECO Approval Routing

This section discusses PeopleSoft Engineering workflows. The workflows are listed alphabetically by workflow name.

Description	
Event Description	PeopleSoft Engineering creates an ECO and submits it for approval.
Action Description	Routes the ECO to various roles for approval, denial, change. When the ECO is submitted, a list of approval users is determined and stored with the ECO. Ad-hoc users can be added for ECO specific approvals.
Notification Method	Worklist

Workflow Objects	
Event	ENGINEERING_ECO_APPROVAL
Workflow Action	ECO NOTIFICATION
Role	User Defined
Approval Rule Set	WF-1 (sample)

ECO Notification

The section discusses the ECR Creation Notification workflow.

Description	
Event Description	Create an ECR.
Action Description	Notifies PeopleSoft Engineering that an ECR has been created.
Notification Method	Worklist

Workflow Objects	
Event	ENGINEERING_ECR_NOTIFY
Workflow Action	ECR NOTIFICATION
Role	Engineering

Promote ECO

The section discusses the Promote ECO workflow.

Description	
Event Description	ECO approval.
Action Description	Notifies the roles defined in the approval routing that an ECO has been created.

Description	
Notification Method	Worklist
Workflow Objects	
Event	ENGINEERING_ECO_APPROVAL
Workflow Action	UPGRADE_ECO_ACTIVITY
Role	User Defined

PeopleSoft Engineering Reports

Appendix: PeopleSoft Engineering Standard Reports

PeopleSoft applications offer a wide range of query and reporting possibilities. In addition to the standard reports that we deliver, we also provide reporting tools that you can use to create new reports.

This topic provides an overview of PeopleSoft Engineering reports and enables you to:

- View summary tables of all reports.
- View report details.
- View standard financial reports.

Note: For samples of these and other reports in your application, see the PDF files published with your online documentation.

See also the product documentation for *PeopleTools: PeopleSoft Process Scheduler*.

PeopleSoft Engineering Standard Reports: General Description

This table lists the PeopleSoft Engineering reports, sorted alphanumerically by report ID. The reports listed are all Structured Query Reports (SQRs). If you need more information about a report, refer to the report details at the end of this topic.

Report ID and Report Name	Description	Navigation	Run Control Page
EGS1000 ECO Report	Lists ECO information for an item or range of items for a specific business unit for a specific date or range of dates. Includes department, classification, ECO status, priority, and the name of the requestor. Can be sorted by classification and ECO number; ECO number; item, schedule date, and priority; priority, schedule date, and ECO number; schedule date, priority, and ECO number; or status, schedule date, and ECO number.	Engineering, Engineering Changes, ECO Report, ECO Report	EG_ECO_REPORT

Report ID and Report Name	Description	Navigation	Run Control Page
ENS1000 BOM Report	Lists the components on either manufacturing or engineering BOMs.	Engineering, BOMs and Revisions, Reports, Bills of Material, EBOM Report	EN_BOM_REPORT
ENS1001 Routing Report	Lists the routing information for both PeopleSoft Manufacturing and PeopleSoft Engineering routings.	Engineering, Routings, Engineering Routing Report, Routing Report	RUN_ENS1001
ENS1002 Compare Routings Report	Lists the differences between two manufacturing routings, two engineering routings, or one manufacturing routing and one engineering routing. Comparisons can also be based on the same item with different routing codes.	Engineering, Routings, Eng Routing Comparison Report, Routing Compare Report	RUN_ENS1002
ENS1003 Master Routing Where Used Report	Lists all items that reference another item as its master routing along with production data. This report is used in both PeopleSoft Manufacturing and PeopleSoft Engineering.	Engineering, Routings, Eng Master Rtg Where Used Rpt, Master Rtg Where Used Report	RUN_ENS1003
ENS1005 Compare BOMs Report	Lists the differences between a manufacturing and an engineering BOM, or two engineering BOMs.	<ul style="list-style-type: none"> • Engineering, BOMs and Revisions, Reports, EBOM Comparison, EBOM Compare Report • Engineering, BOMs and Revisions, Reports, EBOM Comparison, EBOM Compare Report, Print Options 	EN_BOM_COMP_REPORT
ENS1010 BOM Cost Report	Lists the component costs on either manufacturing or engineering BOMs.	Engineering, BOMs and Revisions, Reports, Create EBOM Cost Report	EN_BOM_COST_REPORT
ENS2000 Item Where Used Report	Lists all the BOMs on which an item appears either as a component or a substitute for a component. You'll find this information useful when you want to analyze the impact that component changes can have on all existing BOMs.	Engineering, BOMs and Revisions, Reports, Item Where Used	EN_WHEREUSED_RPT

See also *PeopleTools: PeopleSoft Process Scheduler* documentation.

PeopleSoft Engineering Reports: A to Z

This section provides detailed information about fields for the individual reports in PeopleSoft Engineering. The reports are listed alphanumerically by report ID.

EGS1000 - ECO Report

<i>Field or Control</i>	<i>Description</i>
Status	<p>Select a status. The status indicates where the ECO is in the approval process. You can route notification to the appropriate role user specified for the given workflow step, using workflow virtual approval processing, if enabled. You can print a report for ECOs with these statuses:</p> <ul style="list-style-type: none"> • <i>Approved:</i> The ECO can be routed to the next appropriate user as defined within the approval rule set associated with the ECO type. • <i>Canceled:</i> Workflow notification can be routed back to the previous role user who submitted the ECO or approved the previous activity. • <i>Converted:</i> The ECO was converted from an ECR by the system. The ECR number is referenced on the report. • <i>Denied:</i> Workflow notification can be routed back to the previous role user who submitted the ECO or approved the previous activity. • <i>Pending:</i> If you select this status, you can enter and save Notes text, but no workflow is sent by the system.
Sort Options	<p>Select how you want the report to be sorted. Values are:</p> <ul style="list-style-type: none"> • <i>Classification, ECO Number</i> • <i>ECO Number</i> • <i>Item, Sched Date</i> (schedule date), <i>Priority</i> • <i>Priority, Sched Date, ECO Number</i> • <i>Sched Date, Priority, ECO Number</i> • <i>Status, Sched Date, ECO Number</i>

ENS1000 - BOM Report

<i>Field or Control</i>	<i>Description</i>
<p>Print Options</p>	<p>These options denote detailed information that you may want to appear on the hard copy report. You can select all attributes of the BOM or selected attributes. Attributes include:</p> <ul style="list-style-type: none"> • Substitutes: Substitute items for the BOM components, if any exist. • Lower Level Outputs: Primary, co-product, and by-product items at lower levels of the BOM. • Component Dimensions: Actual dimensions of the component, such as height, length, width, and weight. • Reference Designators: The alphanumeric code that you can use to determine where a component is placed in an assembly. • Component Text: Any text associated with the BOM components. • Component Attachments: The names of any associated assembly attachments. • Component Documents: The names of any associated assembly documents. <hr/> <p>Note: The names of component documents print only if PeopleSoft Engineering is installed.</p> <hr/> <ul style="list-style-type: none"> • Assembly Text: Any text associated with the assembly. • Assembly Attachments: Names of any attachments (files) such as CAD drawings or product specifications. • Assembly Documents: Names of any associated documents used during assembly, such as CAD drawings or product specifications. <hr/> <p>Note: The names of any assembly documents print only if PeopleSoft Engineering is installed.</p> <hr/>

ENS1001 - Routing Report

<i>Field or Control</i>	<i>Description</i>
Print Options	<p>These options denote detailed information that you may want to appear on the report. You can select all or selected attributes to print, such as:</p> <ul style="list-style-type: none"> • Header Documents: Any text associated with the routing header information. • Header Attachments: Any attachments (files) associated with the routing header information. • Operation Resources: Resources that are being used at the operation step. • Operation Time: The times necessary to complete this operation. This may include tasks and run rates such as fixed run, post production, run, and setup times. • Conversion Code: Cost codes that determine the labor, machine, outside processing, and overhead cost of the operation. • Operation Documents: Lists the names of any documents associated with the operation, such as CAD drawings or product specifications. • Operation Attachments: Lists the names of routing operation attachments.

ENS1002 - Compare Routings Report

You use this report to compare baseline and target routing information.

Baseline Routing (RTG1):

Select a routing state. Values are: *Engineering* or *Manufacturing*.

Select an item ID range and a valid routing code.

Target Routing (RTG2):

Engineering appears by default as the routing state; it is a display-only field.

Select an item ID and a valid routing code.

To compare one routing code to another (for example, the primary routing to one of the item's alternates), enter the primary routing code (1) as the from and to routing for the Baseline Routing (RTG1). Then enter as the Target Routing (RTG2) the alternate routing code to which you want to compare the primary.

To see if any of an item's routings are comparable to another item's routing, enter the baseline routing codes (1 to 99 to compare the primary and all alternates) and the target's routing code to which all routings will be compared.

Field or Control	Description
Print Options	<p>These options denote detailed information that you may want to appear on the report. You can select all of the listed attributes, or selected attributes. Attributes include:</p> <ul style="list-style-type: none"> • Header Detail: Information such as routing type, routing code, and routing state is printed on the report. • Header Documents: Any documents associated with the routing header information. • Header Attachments: Any attachments (files) associated with the routing header information. • Ops Sequence (operation sequence): The operation step that components or tasks may be added. • Subcontractor Detail: If the operation step is a subcontracted operation, the supplier information is printed on the report. • Operation Text: Any text associated with the operation step. • Conversion Code: Cost codes that determine the labor, machine, outside processing, and overhead cost of the operation. • Operation Resources: Resources that are being used at the operation step. • Operation Time: The times necessary to complete this operation. This may include tasks and run rates such as fixed run, post production, run, and setup times. • Operation Documents: Lists the names of any documents associated with the operation, such as CAD drawings or product specifications. <hr/> <p>Note: The Operation Documents print option is available only if you have PeopleSoft Engineering installed.</p> <hr/> <ul style="list-style-type: none"> • Operation Attachments: Lists the names of routing operation attachments.

ENS1003 - Master Routing Where Used Report

Field or Control	Description
Print Production Details	<p>Select this check box if you want to print production information for all dates or a range of dates. The report includes all production whose start date falls within the criteria selected.</p>

Field or Control	Description
Status Selection	<p>You can include production by selecting any of these statuses:</p> <ul style="list-style-type: none"> • Entered • Firmed • Released • In Process • Pend Complete (pending complete) • Complete • Clsd Labor (closed to labor) • Clsd Acctg (closed to accounting) • Canceled

ENS1005 - Compare BOMs Report

Use the Compare BOM Report to compare any two engineering BOMs or a manufacturing BOM and an engineering BOM within the same business unit. Using this report, you can compare one or more baseline BOMs to one target BOM. In the **Baseline BOM (BOM1)** group box, specify the item ID BOM that serves as the basis for comparison. The baseline BOM may have an engineering or manufacturing BOM state. The item ID that you specify in the **Target BOM (BOM2)** group box is the BOM that you are comparing with the baseline BOM (BOM1). The target BOM has an engineering BOM state.

Field or Control	Description
Differences	<p>This field behaves the same way for all pages in this group. It displays the differences between the two BOMs. Values are:</p> <ul style="list-style-type: none"> • <i>Added</i>: The component ID has been added to the compare BOM (BOM2). • <i>Deleted</i>: The component has been deleted from the compare BOM (BOM2). <p>The system determines whether a component has been deleted, by comparing the component IDs, operation sequences, and effectivity dates; this is what makes a component unique within a BOM.</p> <ul style="list-style-type: none"> • <i>Chg BOM1</i>: If you have made a component change, you see the components listed. <p>The system lists a change when any information other than component ID, operation sequence, or effective date has changed.</p> <ul style="list-style-type: none"> • <i>Chg BOM2</i>: If you have made a component change, you see the components listed. <p>The system lists a change when any information other than component ID, operation sequence, or effective date has changed.</p>

The report includes component and assembly differences between the two BOMs so that you can use it to track changes.

Baseline BOM (BOM1):

Select the BOM state. Values are: *Engineering* or *Manufacturing*.

Select an item ID and a valid BOM code from the available options.

To use the BOM with a code of *I*, select *I* in both fields. You can also compare all the existing BOMs for the item to the target routing by selecting the appropriate BOM codes.

Select the **All Dates/Revs** check box to compare all effective dates and revisions for the baseline BOMs. To compare a BOM with a specific effective date, deselect the **All Dates/Revs** check box, and enter the specific effective date.

Target BOM (BOM2):

Engineering appears by default as the BOM state; it is display-only.

Select an item ID and a valid BOM code for the target BOM.

Select the **All Dates/Revs** check box to compare all effective dates and revisions for the BOM. To compare a BOM with a specific effective date, enter the specific effective date.

<i>Field or Control</i>	<i>Description</i>
Print Options	<p>These options denote detailed information that you may want to appear on the hard copy report. You can select all attributes of the BOM or selected attributes. Attributes include:</p> <ul style="list-style-type: none"> • Component Documents: The names of any associated assembly documents. <hr/> <p>Note: The names of component documents prints only if PeopleSoft Engineering is installed.</p> <hr/> <ul style="list-style-type: none"> • Component Attachments: The names of any associated assembly attachments. • Component Text: Any text associated with the BOM components. • Reference Designators: The alphanumeric code that you can use to determine where a component is placed in an assembly. • Substitutes: Substitute items for the BOM components, if any exist. • Component Dimensions: Actual dimensions of the component, such as height, length, width, and weight. • Top Level Outputs: Parent assembly items only. • Assembly Header: Any text associated with the assembly. • Assembly Documents: Names of any associated documents used during assembly, such as CAD drawings or product specifications. <hr/> <p>Note: The names of any assembly documents print only if PeopleSoft Engineering is installed.</p> <hr/> <ul style="list-style-type: none"> • Assembly Attachments: Names of any attachments (files), such as CAD drawings or product specifications.

ENS1010 - BOM Cost Report

<i>Field or Control</i>	<i>Description</i>
Cost as Batch	Select this check box if the BOM has multiple outputs.
Print Lower Level Outputs	Select this check box if you want the hard copy report to include the costs of multiple output items for components that are end items.

ENS2000 - Item Where Used Report

You can select all or a range of components, substitutes, or outputs, if any exist for the component. If you select Components, the system searches to see if the items are specified as a component on a BOM. If you select Substitutes, the system searches to see if the item is a substitute item on a BOM. If you select All, the system checks to see if the item is a component or a substitute.

Select the **All Dates/Revs** check box to search all effective dates and revisions for the BOM. To search for components or substitutes effective on a specific date, enter an effective date.

Set **Levels Up** to *1*, to view only the component's parent assembly. The larger the number, the higher the level. For example, level 3 is three levels higher in the bill of material structure than the component.